

# TM-xx Series Table Mount Solutions

# FSR

Metal Products Group



**TM-UT1-BLK shown with T6-LB-AC2CH-CC    TM-OT1CL-BLK shown with T6-LB-AC2CH-CC**

## DESCRIPTION

Whether your table mounting application calls for mounting on, over, or under desk, our TM Series table mounts provide the solutions you need. FSR offers a wide variety of fully populated bracket options featuring AC outlet power, USB charging, and openings for our Intelligent Plate Solutions (IPS), SS Keystone connectors, and cables. These attractive mounting solutions are available in black.

## APPLICATIONS

- Court Rooms
- Desks
- Boardroom Tables
- Lecterns
- Cubicles
- Control Consoles
- Lab Tables
- Classrooms
- Collaboration Tables
- Multi-Purpose Tables

## FEATURES

- Can be mounted in a wide variety of tables
- Connector plates are available to match the specific application and customer needs
- Can be reconfigured at any time as requirements change

## TM-xx ORDERING TABLE

Item #	Part #	Description
17976	TM-UT1-BLK	Undertable Mount For T6-LB Family of Inserts
17980	TM-OT1CL-BLK	On-table Mount For T6-LB Family of Inserts
17984	TM-OT1SM-BLK	On-table Mount For T6-LB Family of Inserts

## T6-LB LARGE BRACKETS

Item #	Part #	Description
18536	T6-LB-AC2CH-CC	T6 Large Bracket w/ 2AC, 1 USB-A, 1 USB-C
17960	T6-LB-AC2U1	T6 Large Bracket w/ 2 AC outlets with 1 additional AC outlet in rear
17962	T6-LB-AC3RR	T6 Large Bracket w/ 3 outlets with center outlet rotated
17068	T6-LB-AC3HW	T6 Large Bracket w/ 3 AC Outlets – with pigtails for hard wiring
17914	T6-LB-UN	T6 Large Bracket for mounting of 4 IPS inserts or 6 cables
17070	T6-LB-5SS	T6 Large Bracket for mounting of 5 SS Snap In Connectors

## FSR Inc.

244 Bergen Boulevard, Woodland Park, NJ 07424

Phone: 973.998.2300 · Fax: 973.785.4207

Order Desk: 1-800-332-FSR1

Web: fsrinc.com · E-mail: sales@fsrinc.com    LIT1646F

# DIMENSIONS

## TM-UT1

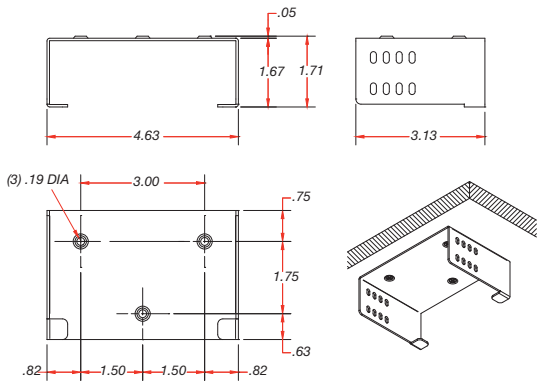

5/8" LONG MOUNTING WOOD SCREWS PROVIDED

## TM-OT1CL

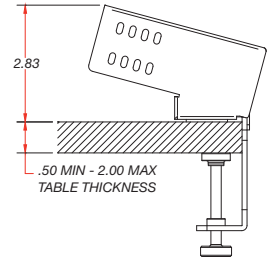
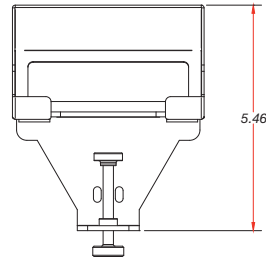
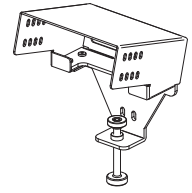
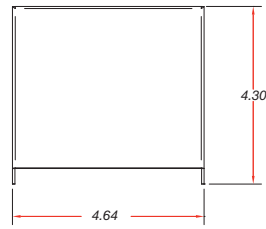

## TM-OT1SM

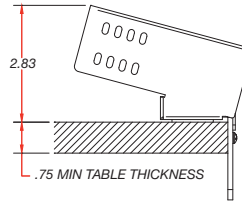
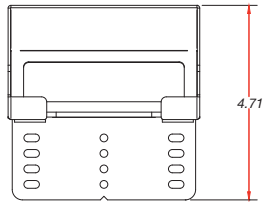
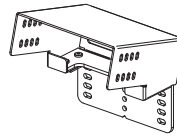
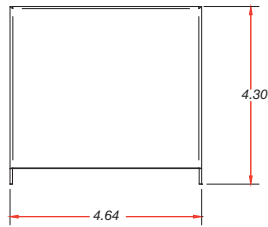

1/2" LONG MOUNTING WOOD SCREWS PROVIDED