

TB-BOSE TB-BOSE-IPS Table Boxes

FSR

Metal Products Group

TB-BOSE



Speaker provided by customer

DESCRIPTION

The new TB-BOSE and TB-BOSE-IPS table boxes are tilt top style table boxes designed specifically to contain a Bose™ FreeSpace 3 Surface-Mount Satellite Cube Speaker. There are 2 basic sizes of table box, the TB-BOSE contains the speaker only and the TB-BOSE-IPS contains the speaker and a section to the right of the speaker for up to four (4) IPS (Intelligent Plate Solutions) insert plates.

The TB-BOSE and TB-BOSE-IPS table boxes are available in Black Anodized finish. In the open position the speaker will be at approximately a 35° angle from vertical. This is to accommodate a seated person at the table with the box being 22" from the edge of the table. There is up to 4" of clearance behind the IPS plate surface.

IPS INSERTS

The IPS (Intelligent Plate Solutions) line offers a wide variety of interconnect solutions that satisfies virtually any AV and DATACOM interface application. Customizing just became standard at budget friendly prices. Create unlimited combinations of connector inserts with this diverse assortment of IPS inserts that work well with the TB-BOSE-IPS table box.

The insert connectors are mounted to steel plates insuring a lifetime of service. The inserts are available with no labeling, standard labeling, or FSR will custom label them for you as well. Additionally, our IPS inserts can be changed at any time for easy upgrade. All IPS inserts carry a limited lifetime warranty.

APPLICATIONS

- Court Rooms
- Desks
- Boardroom Tables
- Lecterns
- Control Consoles
- Lab Tables
- Classrooms

FEATURES

- Can be mounted in a wide variety of tables with thicknesses ranging from .75" to 2.25"
- Available with or without an area for four (4) IPS (Intelligent Plate Solutions) insert plates
- IPS inserts can use FSR IPS-D717S USB Chargers
- Connector plates can be populated to match the application and customer needs
- Can be reconfigured at any time as requirements change
- Available in Black Anodized finish

FSR Inc.

244 Bergen Boulevard, Woodland Park, NJ 07424

Phone: 973.785.4347 · Fax: 973.785.4207

Web: www.fsrinc.com · E-mail: sales@fsrinc.com LIT1495A

OVERALL DIMENSIONS

Speaker provided by customer.

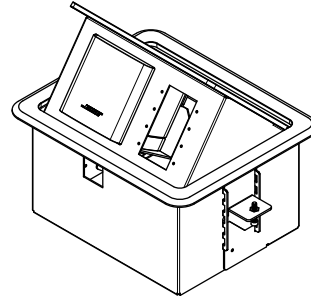
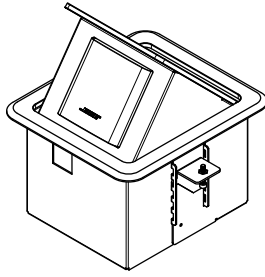

There is up to 4" of clearance behind the IPS plate surface.

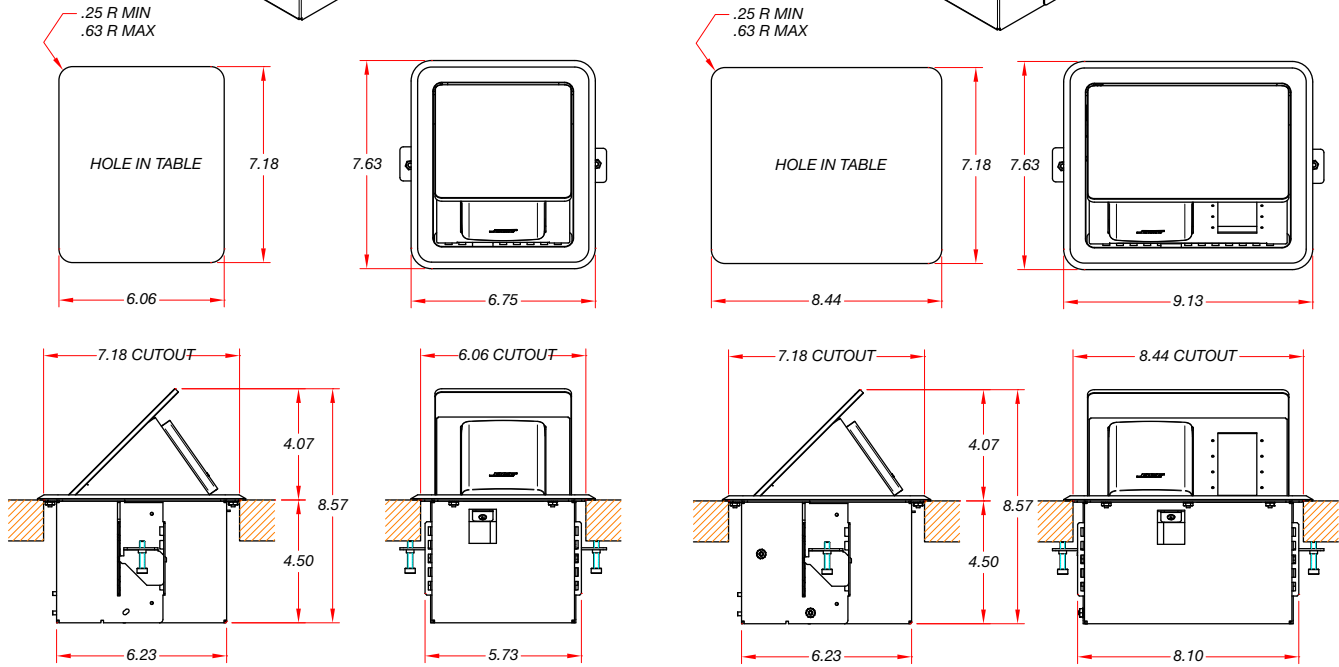

ISP INSERT ASSORTMENT

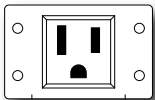

IPS-AC110D
AC Outlet to Edison Plug
(Under Table Use Only)
Black Only



IPS-V610S
HDMI to HDMI
Bulkhead

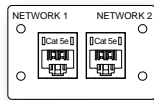

IPS-D720D-LB
2 x RJ-45
Punch-Down
(Labeled)



IPS-AV231S-LB
Red, White and
Yellow RCA's
to RCA's
(Labeled)



IPS-B040S
1 Keystone
Opening

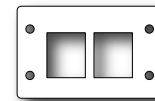

IPS-B041D
2 Keystone
Opening

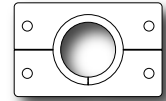

IPS-B010D
1 x .812" ID Split
Bushing

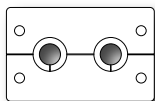

IPS-B020D
2 x .312" ID
Split Bushing

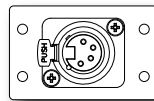

IPS-C610D
2 x 4 Pin Female
XLR to Solder



IPS-C611S
4 Pin Mini XLR
to Captive
Screw Terminal

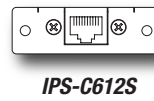

IPS-C612S
TPS Block 10
Connector

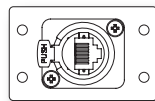

IPS-C710D
Neutrik EtherCon
RJ-45

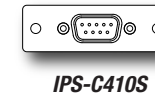

IPS-C410S
9 Pin DSub Male
to Female
Bulkhead



IPS-B000Q
Quad Height
Blank

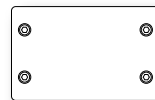

IPS-B000D
Double Height
Blank



IPS-B000S
Single Height
Blank

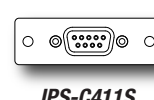

IPS-C411S
9 Pin DSub Male
to Solder



IPS-D717S
(Blk, Wht, Iv)

Some of the hundreds of IPS Inserts offered by FSR. For more options visit www.fsrinc.com or refer to LIT1443

Specifications are subject to change without notice.

