

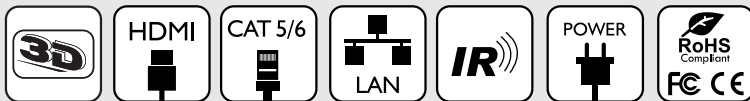

Control Your Video

VIDEO WALLS VIDEO PROCESSORS
VIDEO MATRIX SWITCHES
EXTENDERS SPLITTERS WIRELESS
CABLES & ACCESSORIES

4 X 4 HDMI HDBaseT Lite CAT5e/6/7 Matrix with 3D Support and Bi-Directional IR



Model #: SW-HBT-C6IRLT-4X4E

© 2015 Avenview Inc. All rights reserved.

The contents of this document are provided in connection with Avenview Inc. ("Avenview") products. Avenview makes no representations or warranties with respect to the accuracy or completeness of the contents of this publication and reserves the right to make changes to specifications and product descriptions at any time without notice. No license, whether express, implied, or otherwise, to any intellectual property rights is granted by this publication. Except as set forth in Avenview Standard Terms and Conditions of Sale, Avenview assumes no liability whatsoever, and claims any express or implied warranty, relating to its products are strictly prohibited.

Product Application & Market Sectors



Corporate



House Of Worship



Military



Residential



Education



Industrial



Medical



Aviation



TABLE OF CONTENTS

| | | |
|-------|---|----|
| 1. | GETTING STARTED | 3 |
| 1.1 | IMPORTANT SAFEGUARDS..... | 3 |
| 1.2 | SAFETY INSTRUCTIONS..... | 3 |
| 1.3 | REGULATORY NOTICES FEDERAL COMMUNICATIONS COMMISSION (FCC)..... | 4 |
| 2. | INTRODUCTION AND FEATURES..... | 5 |
| 2.1 | PACKAGE CONTENTS..... | 6 |
| 2.2 | BEFORE INSTALLATION..... | 7 |
| 2.3 | CABLE SPECIFICATIONS | 7 |
| 2.4 | APPLICATION DIAGRAM..... | 8 |
| 3. | PANEL DESCRIPTION | 9 |
| 3.1 | FRONT PANEL (SW-HBT-C6IRLT-4X4E) | 9 |
| 3.2 | REAR PANEL (SW-HBT-C6IRLT-4X4E)..... | 10 |
| 3.3 | COMPATIBLE RECEIVERS (SW-C6IRLT-R) | 10 |
| 3.3.1 | RECEIVER FRONT AND REAR PANEL (SW-C6IRLT-R) | 11 |
| 3.3.2 | RECEIVER (SW-C6IRLT-R) SPECIFICATIONS | 11 |
| 4. | IR REMOTE AND CABLE DEFINITION | 12 |
| 5. | INSTALLATION..... | 13 |
| 6. | RS 232 PROTOCOLS | 14 |
| | SECTION 7: SPECIFICATIONS..... | 15 |



SECTION I: GETTING STARTED

I.1 IMPORTANT SAFEGUARDS

Please read all of these instructions carefully before you use the device. Save this manual for future reference.

What the warranty does not cover

- Any product, on which the serial number has been defaced, modified or removed.
- Damage, deterioration or malfunction resulting from:
 - Accident, misuse, neglect, fire, water, lightning, or other acts of nature, unauthorized product modification, or failure to follow instructions supplied with the product.
 - Repair or attempted repair by anyone not authorized by us.
 - Any damage of the product due to shipment.
 - Removal or installation of the product.
 - Causes external to the product, such as electric power fluctuation or failure.
 - Use of supplies or parts not meeting our specifications.
 - Normal wear and tear.
 - Any other causes which does not relate to a product defect.
- Removal, installation, and set-up service charges.



I.2 SAFETY INSTRUCTIONS

The **SW-HBT-C6IRLT-4X4E** HDBaseT HDMI & CAT5/6/7 Matrix has been tested for conformance to safety regulations and requirements, and has been certified for international use. However, like all electronic equipments, the SW-HBT-C6IRLT-4X4E should be used with care. Read the following safety instructions to protect yourself from possible injury and to minimize the risk of damage to the unit.

- ⚠ Do not dismantle the housing or modify the module.
- ⚠ Dismantling the housing or modifying the module may result in electrical shock or burn.
- ⚠ Refer all servicing to qualified service personnel.
- ⚠ Do not attempt to service this product yourself as opening or removing housing may expose you to dangerous voltage or other hazards
- ⚠ Keep the module away from liquids.
- ⚠ Spillage into the housing may result in fire, electrical shock, or equipment damage. If an object or liquid falls or spills on to the housing, unplug the module immediately.
- ⚠ Have the module checked by a qualified service engineer before using it again.
- ⚠ Do not use liquid or aerosol cleaners to clean this unit. Always unplug the power to the device before cleaning.



This equipment has been tested and found to comply with Part 15 of the FCC rules. These limits are designed to provide reasonable protection against harmful interference in a residential installation. Any changes or modifications made to this equipment may void the user's authority to operate this equipment.

| Warning symbols | Description |
|--|---|
|  | <p>ONLY USE THE PROVIDED POWER CABLE OR POWER ADAPTER SUPPLIED. DO NOT TAMPER WITH THE ELECTRICAL PARTS. THIS MAY RESULT IN ELECTRICAL SHOCK OR BURN.</p> |
|  | <p>DO NOT TAMPER WITH THE UNIT. DOING SO WILL VOID THE WARRANTY AND CONTINUED USE OF THE PRODUCT.</p> |
|  | <p>THE VIDEO BOARDS ARE VERY SENSITIVE TO STATIC. PLEASE ENSURE IF RACK MOUNTED OR INSTALLED ON A SURFACE, IT SHOULD BE IN A GROUNDED ENVIROMENT.</p> |

| | |
|---|--|
|  | <p>⚠ WARNING</p> <p>Read & understand user guide before using this device.</p> <p>Failure to follow the proper installation instructions could result in damage to the product and preventing expected results.</p> |
|---|--|



2. INTRODUCTION

The SW-HBT-C6IRLT-4X4E HDBaseT™ Lite HDMI Matrix is designed to accept Full HD 1080p and WUXGA 1920X1200 @60 Hz(RB) signal from 4 DVI/HDMI sources to any of the connected 4 displays over CAT5/6 cable upto 60m (196 feet). This matrix model has been tested and proven to be cost effective and reliable within the market sector because of its HDBaseT chipset technology inside.

The unit supports not only transmission of video but multi-channel digital audio and bi directional control via IR to four displays for true digital experience over a single CAT5e/6/7 cable (up to 60m). Please note this matrix supports high resolution digital audio formats such as LPCM 7.1CH, Dolby TrueHD, Dolby Digital Plus and DTS-HD Master Audio as well as 3D content that can be displayed when connecting a 3D TV and 3D source.

Bonus feature with all our matrix series family it allow users to control the seamless matrix switching functionality via WEB GUI over LAN with any device that supports web browser application. Example iPad, Android device or Windows 8 touch device.

FEATURES

- HDMI, HDCP1.1 and DVI compliant,
- Supports HDMI 3D features,
- Supports resolutions VGA~WUXGA and 480i~1080p dependent upon the output display's EDID settings,
- Supports distances up to 60 meters through CAT5e/6/7 cables,
- Supports 3D signal display dependent upon the output display EDID settings,
- Supports HDMI input up to 15 meters at 8-bit resolution or 10 meters at 12-bit resolution,
- Supports bi-directional IR from input and output locations,
- Supports RS-232, remote control, on-panel control and IP Control (Telnet & Web GUI),
- 1 U size design,
- Supports external and internal EDID settings,
- Supports LPCM 7.1CH, Dolby TrueHD, Dolby Digital Plus and DTS-HD Master Audio transmission.

NOTE: Receivers (Rx) from different manufactures and non HDBaseT would not be compatible.



Displaying Full HD 1080p resolution would require the standard HDMI cable and display for accurate results.

Do not connect CAT inputs/outputs of this device to a POE network switch.

Doing so may damage the unit.

Only connect LAN port to a network.



Before you start the installation of the converter, please check the package contents.

| | | | |
|---|-----------------------------|----|---|
| 1 | SW-HBT-C6IRLT-4X4E | x1 |  |
| 2 | SW-C6IRLT-R | x4 |  |
| 3 | IR RECEIVER | x1 |  |
| 4 | IR BLASTER | x1 |  |
| 5 | IR REMOTE | x1 |  |
| 6 | Power Adapter (24V/2.7A DC) | x1 |  |
| 7 | User's Manual | x1 |  |



2.2 BEFORE INSTALLATION

- Put the product in an even and stable location. If the product falls down or drops, it may cause an injury or malfunction.
- Don't place the product in too high temperature (over 50°C), too low temperature (under 0°C) or high humidity.
- Use the DC power adapter with correct specifications and supplied with the unit. If improper power supply is used the unit may malfunction and cause a fire.
- Do not twist or pull by force ends of the UTP cable. It can cause malfunction.

2.3 CABLE SPECIFICATIONS



To achieve best results with our SW-HBT-C6IRLT-4X4E we highly recommend a premium quality 26 or 24 AWG HDMI cable with the below specifications to maintain signal integrity and distances.

FEATURES:

- Length: 5m (16ft) to 15m (50ft)
- Bandwidth: 10.2 Gbps data transfer rate
- Supports Resolution: Up to 3840x2160 @ 24Hz and 4096x2160 @ 24Hz, 1080p @ 24Hz / 50/60Hz/3D
- Conductor gauge: 26 / 24 AWG
- Deep Color
- 3D Capable
- CEC
- Ethernet Channel
- Audio Return Channel
- Connector 1: HDMI (Type A) Male
- Connector 2: HDMI (Type A) Male



2.4 APPLICATION DIAGRAM

SW-HBT-C6LT-4X4E

CABLE INDEX

- Input / Output ■
- RS-232 ■
- IR ■
- CAT-5e / CAT-6 ■
- LAN NETWORK ■

1080p(1920x1080) = 60m (196 feet) CAT6E 250MHz
 WXGA(1920x1200) = 60m (196 feet) CAT6E 250MHz

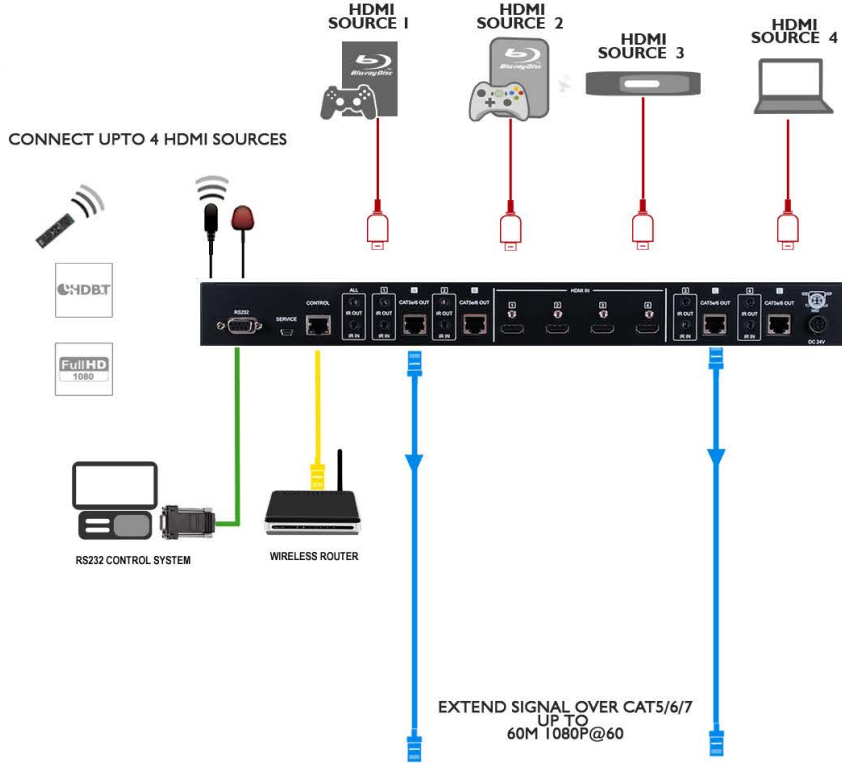

SW-C6IRLT-R RECEIVER-RX



SW-C6IRLT-R RECEIVER-RX

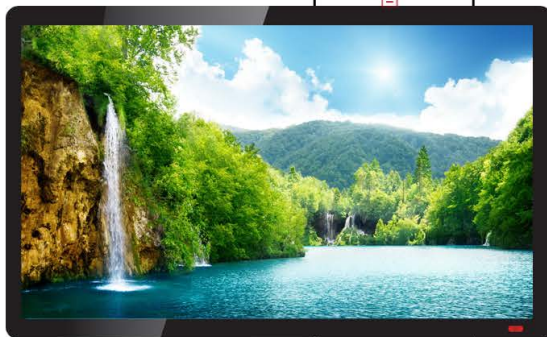
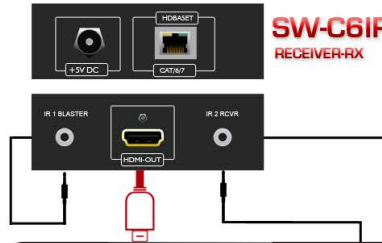

CONNECT UPTO 4 HDMI SCREENS



3. PANEL DESCRIPTION

3.1 FRONT PANEL (SW-HBT-C6IRLT-4X4E)

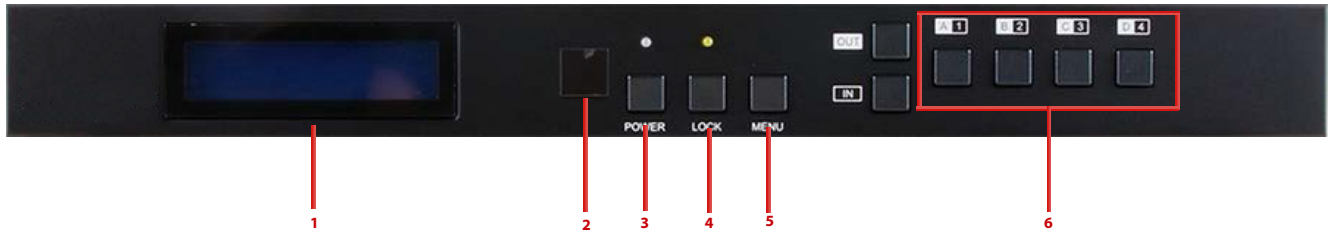

| | |
|--|---|
| <p>1. LCM: Displays the information of the input and output settings.</p> | <p>2. IR: IR Receiver window (accepts the remote control signal of this matrix only).</p> |
| <p>3. POWER: (LED Status) GREEN Power ON, RED Standby Mode.</p> | <p>4. LOCK: Press for 3 seconds to lock all the buttons on the panel; press again for 3 seconds to unlock. The LED Status Green when locked.</p> |
| <p>5. MENU: Press to access the FPM system, Easily manage EDID settings and quickly access the IP info of device.</p> | <p>6. A~D/1~4 and In/Out: Press Out or In button to select the output or input mode and then press the preferred number to manually setup your solution.</p> |



PANEL DESCRIPTION

3.2 REAR PANEL (SW-HBT-C6IRLT-4X4E)

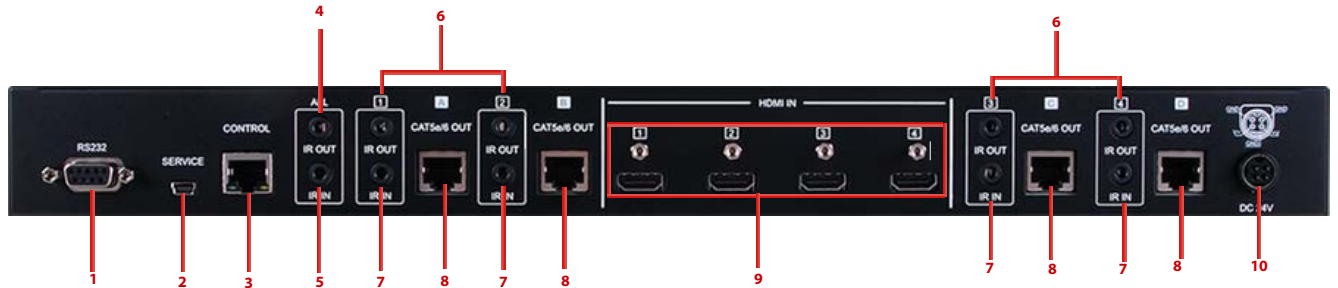

| | |
|--|--|
| <p>1. RS-232: Connect to PC or control system with D-Sub 9-pin cable for the transmission of RS-232 commands.</p> | <p>2. SERVICE: Manufacturer use only. (Mini-USB for firmware updates).</p> |
| <p>3. IP/ETHERNET: Telnet and WebGUI control. (allows ethernet access when connecting to an active network source)</p> | <p>4. ALL IR OUT: Connect to IR blaster for IR signal transmission to source side. Place the IR blaster in direct line-of-sight of the equipment to be controlled for it will blaster out all signal received from the IR IN at the receiver sides.</p> |
| <p>5. ALL IR IN: Connect to IR extender receiver for IR signal reception. Ensure that remote being used is within the direct line-of-sight of the IR receiver for it will send out the signal to all receiver's IR OUT.</p> | <p>6. IR OUT 1~4: Connect to IR blasters for IR signal transmission.</p> |
| <p>7. IR IN 1~4: Connect to IR extender receivers for IR signal reception.</p> | <p>8. CAT5e/6/7: Connect to any HD monitor/ display.</p> |
| <p>9. HDMI IN 1~4: Connect to HDMI input source.</p> | <p>10. DC 24V MAIN POWER: Plug the 24 V DC power supply into the unit.</p> |



3.3 COMPATIBLE RECEIVERS (SW-C6IRLT-R)

3.3.1 RECEIVER FRONT AND REAR PANEL (SW-C6IRLT-R)



| | |
|--|---|
| 1. IR-1 IN: Connect IR receiver to receive and transmit signal to IR-1 Out at the transmitter unit | 2. HDMI OUT: Connect to HDMI input (TV or Monitor) to view the HDMI input signal. |
| 3. IR-2 OUT: Connect to IR Blaster to send signal to the display (TV or Monitor). | 4. DC-5V: Connect the 5V DC power supply to the unit and plug the adaptor into an AC outlet. |
| 5. CAT5e/6 IN: Connect to sender unit with a single CAT5e/6/7 cable for transmission of data signals. Yellow LED will illuminate when both transmitter and receiver are powered and connected together. | |

3.3.2 RECEIVER (SW-C6IRLT-R) SPECIFICATIONS

| Item | Description | |
|-----------------------------------|---|---|
| UNITS | SW-C6IRLT-R | |
| UNIT DESCRIPTION | HDBaseTTM Lite HDMI over Single CAT5e/6/7 Extender | |
| Video Bandwidth | 300 MHz/10.2 Gbps | |
| HDCP and DVI | Compliant | |
| DATA RATE | 5.3 Gbps | |
| HDMI SUPPORTED RESOLUTIONS | 480i @ 60Hz, 480p @ 60Hz, 576i @ 50Hz, 576p @ 50Hz, 720p @ 50/60Hz/3D, 1080i @ 50/60Hz, 1080p @ 24Hz / 50/60Hz/3D, ULTRA HD (3840x2160)@24Hz 4K × 2K @ 24Hz | |
| INPUT | Sender 1 × HDMI, 1 × IR Extender | Receiver 1 × CAT5e/6/7, 1 × IR Extender |
| OUTPUT | 1 × CAT5e/6/7, 1 × IR Blaster | 1 × HDMI, 1 × IR Blaster |
| HDMI CABLE | 4K2K: (3840X2160@24Hz) ~ 35meter (115 feet) FULL HD: (1080p) ~ 60meter (197 feet) | |
| AUDIO SUPPORT | LPCM 7.1CH, Dolby TrueHD, Dolby Digital Plus and DTS-HD Master Audio | |
| DIMENSIONS (L X W X H) | 2.2" x 3.2" x 0.88" (Sender and Receiver) | |
| WEIGHT | 0.12 lb (Sender) / 0.14 (Receiver) | |
| POWER SUPPLY | 5 V/2.6 A DC (US/EU standards, CE/FCC/UL certified) | |
| POWER CONSUMPTION | 3 W/TX, 5.5 W/RX | |
| <i>Environmental</i> | | |
| OPERATING TEMPERATURE | 32° ~ 104°F (0° to 40°C) | |
| STORAGE TEMPERATURE | -4° ~ 140°F (-20° ~ 60°C) | |
| RELATIVE HUMIDITY | 20~90% RH (non-condensing) | |



4. IR REMOTE AND CABLE DEFINITION

REMOTE CONTROL

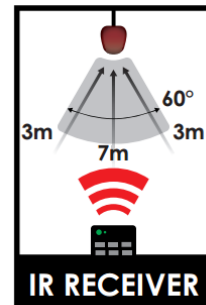
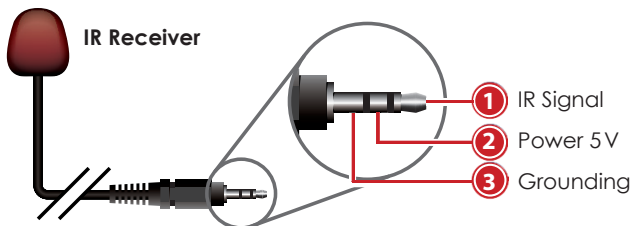
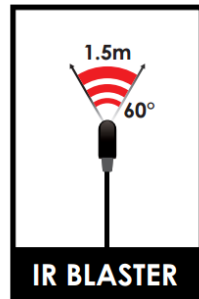
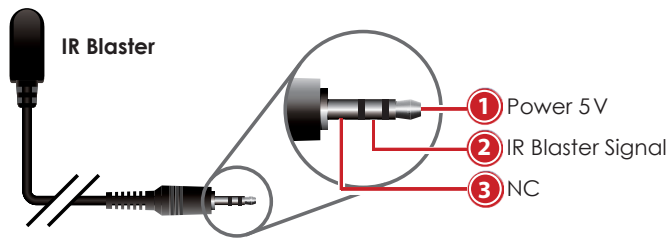
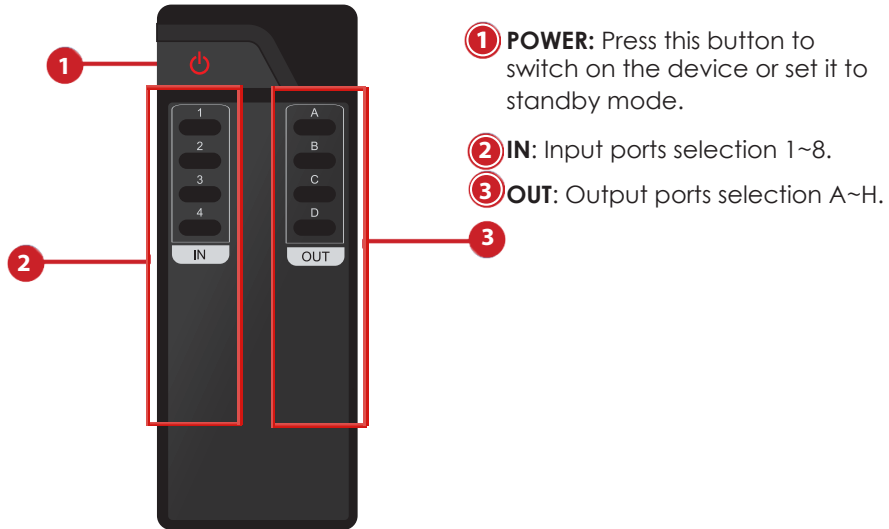

IR Sockets

IR BLASTER: plug in the IR blaster to the SW-HBT-C6IRLT-4X4E to emit all IR command signals received from the IR Receiver plugged into the Rx (Monitor Side) to control the devices corresponding to the IR signals.
Example: Set Top Box or DVD player (The Source).

IR RECEIVER: plug in the IR receiver into the (RX) Receiver (Monitor Side) to receive all IR command signals from the IR remote controls of the corresponding source.
Example: Set Top Box or DVD player (IR Remote Control).





NOTE: Incorrect placement of IR Blaster and IR Receiver into the extender may result in the failure of the IR extenders.

Please check carefully before plugging in the IR extender to the respective IR sockets. It is clearly marked and IR 1: IR RECEIVER/EXTENDER / IR 2: IR BLASTER

WARRANTY WILL NOT COVER THE DAMAGE

| Data Link TIA/EIA-568-B | | |
|-------------------------|-------|----------|
| PIN | Color | Function |
| 1 | W-O | TX0- |
| 2 | O | TX0+ |
| 3 | W-G | TX1- |
| 4 | BL | TX2- |
| 5 | W-BL | TX2+ |
| 6 | G | TX1+ |
| 7 | W-BR | TXC- |
| 8 | BR | TXC+ |

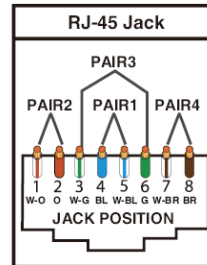

NOTE

The **QUALITY** and **TRANSMISSION** of the video signals depends on the characteristics and quality of the UTP cables. Higher resolutions and longer transmission distances require low skew cables (<25ns/upto 300m) for best performance.

Unshielded CAT6 with metal RJ-45 connectors is recommended.



5. INSTALLATION (SW-HBT-C6IRLT-4X4E)

To setup Avenview **SW-HBT-C6IRLT-4X4E** please follow these steps for connecting to a device:

1. Turn off all devices including monitors / TV
2. Connect to a HDMI source 1080p (such as a Blu-Ray Disc player) to the matrix unit.
3. Connect a SW-C6IRLT-R receiver with CAT5/6/7 cable and HDMI out to monitor.
4. Plug the supplied power supply 5V/2.6A to the Receiver unit
5. Plug in the IR BLASTER: into IR out and the blinker on the IR eye (Source)
6. Plug in the IR Receiver to IR IN to receive IR Signals from Remote (Monitor end)
7. Power on the HDMI display
8. Power on HDMI Sources



6. RS-232 PROTOCOLS

| SW-HBT-C6POE-16x16E | |
|---------------------|------------|
| PIN | Definition |
| 1 | NC |
| 2 | TxD |
| 3 | RxD |
| 4 | NC |
| 5 | GND |
| 6 | NC |
| 7 | NC |
| 8 | NC |
| 9 | NC |

| Third Party RS-232 Controller | |
|-------------------------------|------------|
| PIN | Definition |
| 1 | NC |
| 2 | TxD |
| 3 | RxD |
| 4 | NC |
| 5 | GND |
| 6 | NC |
| 7 | NC |
| 8 | NC |
| 9 | NC |

Baud Rate: 9200bps

Data Bit: 8 bits

Parity: None

Stop Bit: 1

Flow Control: None



SECTION 7: SPECIFICATIONS

| ITEM | DESCRIPTION |
|-------------------------|--|
| UNITS | SW-HBT-C6IRLT-4X4E |
| UNIT DESCRIPTION | HDMI HDBaseT Lite CAT5e/6/7 Matrix |
| HDCP | YES |
| VIDEO BANDWIDTH | 225 MHz/6.75 Gbps |
| SUPPORTED RESOLUTIONS | 480i~1080p@50/60 (1920x1080), 1080p@24, WUXGA (1920X1200), 3D |
| AUDIO SUPPORT | LPCM 7.1CH, Dolby TrueHD, Dolby Digital Plus and DTS-HD Master Audio |
| HDMI IN CABLE M/M | 15m/1080p@8-bit or 6m/1080p@12-bit |
| ESD PROTECTION | Human body model — ±8kV (air-gap discharge) & ±4kV (contact discharge) |
| INPUT | 4×HDMI/DVI, 5×IR Receiver, 1×RS-232, 1×RJ-45 , 1×Mini USB Type B (For firmware updates only) |
| OUTPUT | 4×CAT5e/6/7, 5×IR Blaster |
| HDMI CABLE I/O DISTANCE | 15m/8-bits, 10m/12-bits |
| HDMI CONNECTOR | Type A (19 pin female) |
| IR FREQUENCY | 30~50kHz |
| DIMENSIONS (L X W X H) | 17' (W) x 10' (D) x 1.8' (H) |
| NET WEIGHT | 7.1 lbs |
| POWER SUPPLY | 24 V/2.7 A DC (US/EU standards, CE/FCC/UL certified) |
| POWER CONSUMPTION | 35 W |
| ENVIRONMENTAL | |
| OPERATING TEMPERATURE | 32° ~ 104°F (0° to 40°C) |
| STORAGE TEMPERATURE | -4° ~ 140°F (-20° ~ 60°C) |
| RELATIVE HUMIDITY | 20~90% RH (non-condensing) |



NOTICE

1. All HDMI over UTP transmission distances are measured using Belden CAT6A (625MHz), 4-Pair, U/UTP-Unshielded, Riser-CMR, Premise Horizontal Cable, 23 AWG Solid Bare Copper Conductors, Polyolefin Insulation, Patented Double-H spline, Ripcord, PVC Jacket using Quantum 980 signal HDMI Video Generator Module Video Pattern Testing.
2. The transmission length is largely affected by the type of category cables, also the type of HDMI sources, and the type of HDMI display. The testing result shows solid UTP cables (usually in the form of 300m or 1000ft bulk cable) can transmit a lot longer signals than stranded UTP cables (usually in the form of patch cords). Shielded STP connectors are better suit than unshielded UTP connectors. A solid UTP CAT5e cable shows longer transmission length than stranded STP CAT6 cable. For long extension users, solid cables are your only choice.
3. EIA/TIA-568-B termination (T568B) for category cables is recommended for better performance.
4. To reduce the interference among the unshielded twisted pairs of wires in category cable, you can use shielded STP cables with shielded connector to improve EMI problems, which occurs in long transmission.
5. Because the quality of the category cables has the major effects in how long transmission distance will be made and how good is the received display, the actual transmission length is subject to your category cables. For resolution greater than 1080i or 1280x1024, a solid CAT6 cable is the only viable choice.

PERFORMANCE GUIDE FOR HDMI OVER CATEGORY CABLE TRANSMISSION

| PERFORMANCE RATING | | TYPE OF CATEGORY CABLE | | |
|--------------------|------------------|--|-------|---------|
| WIRING | SHIELDING | CAT5e | CAT6 | CAT6A/7 |
| SOLID | UNSHIELDED (UTP) | ★★★★★ | ★★★★★ | ★★★★★ |
| | SHIELDED (STP) | ★★★ | ★★★★ | ★★★★ |
| STRANDED | UNSHIELDED (UTP) | ★ | ★★ | ★★ |
| | SHIELDED (STP) | ★★ | ★ | ★★ |
| TERMINATION | | PLEASE USE EIA/TIA-568-B TERMINATION (T568B) AT ANY TIME | | |



Notes



Avenview Warranty Certificate

AVENVIEW CORP. ("Avenview") warrants Avenview-branded product(s) contained in the original packaging against defects in materials and workmanship when used normally in accordance with Avenview's enclosed manual guidelines for a period of THREE (3) YEARS from the date of original retail purchase - Warranty Period. Avenview's published guidelines include but are not limited to information contained in technical specifications, user manuals and service communications.

LABOR: During the Warranty Period of THREE (3) YEARS, Avenview will repair or replace the product(s) at no cost using new or used parts equivalent to novel performance and reliability if the product(s) is determined to have abide by Avenview's published guidelines. Cost of Labor applicable to product(s) after Warranty Period. For labor costs, please contact support@avenview.com.

PARTS: During the Warranty Period of of THREE (3) YEARS, Avenview will supply new or rebuilt replacements in exchange for defective parts of the product(s) at no cost if the product(s) is determined to have abide by Avenview's published guidelines. Cost of Parts applicable to product(s) after Warranty Period. For part(s) costs, please contact support@avenview.com.

To obtain Warranty: (a) proof of purchase in the form of a bill of sale or receipted invoice reflecting that the registered product(s) is within warranty period must be presented to obtain warranty service; (b) product(s) must be registered at time of purchase. Failure to do so will result in applicable parts and labor charges. Returning product(s) must be shipped in Avenview's original packaging or in packaging pertaining equal degree of protection to Avenview's. Both Avenview and purchaser are responsible for freight charges and brokerages when shipping the product(s) to the receiver.

NOT COVERED BY THIS WARRANTY

This warranty does not apply to any non-Avenview branded product(s); non-registered Avenview product(s). This warranty does not apply: (a) to cosmetic damage, including but not limited to scratches, dents and broken cords; (b) to damage caused by use with another product; (c) to damage caused by accident, abuse, misuse, liquid contact, fire, earthquake or other external cause; (d) to damage caused by operating the Avenview product(s) outside Avenview's manuals or guidelines; (e) to damage caused by service performed by anyone who is not a representative of Avenview or an Avenview authorized personnel; (f) to defects caused by normal wear and tear or otherwise due to the normal aging of the Avenview product(s), or (g) if any serial number has been removed or defaced from the Avenview product(s).

AVENVIEW IS NOT LIABLE FOR DIRECT, SPECIAL, INCIDENTAL OR CONSEQUENTIAL DAMAGES RESULTING FROM ANY BREACH OF WARRANTY OR CONDITION, OR UNDER ANY OTHER LEGAL THEORY, INCLUDING BUT NOT LIMITED TO LOSS OF USE; LOSS OF REVENUE; LOSS OF ACTUAL OR ANTICIPATED PROFITS (INCLUDING LOSS OF PROFITS ON CONTRACTS); LOSS OF THE USE OF MONEY; LOSS OF ANTICIPATED SAVINGS; LOSS OF BUSINESS; LOSS OF OPPORTUNITY; LOSS OF GOODWILL; LOSS OF REPUTATION; LOSS OF, DAMAGE TO, COMPROMISE OR CORRUPTION OF DATA; OR ANY INDIRECT OR CONSEQUENTIAL LOSS OR DAMAGE REPAIR OR REPLACEMENT AS PROVIDED UNDER THIS WARRANTY IS THE EXCLUSIVE REMEDY OF THE CONSUMER.

Some states do not allow the inclusion or limitation of incidental or consequential damages, or allow limitations on duration implements of the Warranty Period; therefore the above limitations or exclusions may not be applicable to you. This warranty gives you specific legal rights, and you may have other rights which vary from state to state.



275 Woodward Avenue, Kenmore, NY 14217
1.866.508.0269





TECHNICAL SUPPORT

CONTACT US



Phone: 1 (866) 508 0269



Email: support@avenview.com



USA Head Office Avenview Corp. 275 Woodward Avenue Kenmore, NY 14217

USA Head Office

Office Avenview
Corp. 275 Woodward Avenue
kenmore, Ny 14217
phone: +1.716.218.4100 ext223
f ax: +1.866.387-8764
Email: info@avenview.com

Canada Sales

Avenview
151 Esna park Drive, u nit 11 & 12
Markham, Ontario, l 3R 3B l
phone: 1.905.907.0525
f ax: 1.866.387.8764
Email: info@avenview.com

Avenview Europe

Avenview Europe
Demkaweg 11
3555 HW u trecht
Netherlands
phone: +31 (0)85 2100- 613
Email: info@avenview.eu

Avenview Hong Kong

u nit 8, 6/f., k wai Cheong Centre,
50 k wai Cheong Road,
k wai Chung, N.T.
Hong kong
phone: 852-3575 9585
Email: wenxi@avenview.com

Disclaimer

While every precaution has been taken in the preparation of this document, Avenview Inc. assumes no liability with respect to the operation or use of Avenview hardware, software or other products and documentation described herein, for any act or omission of Avenview concerning such products or this documentation, for any interruption of service, loss or interruption of business, loss of anticipatory profits, or for punitive, incidental or consequential damages in connection with the furnishing, performance, or use of the Avenview hardware, software, or other products and documentation provided herein.

Avenview Inc. reserves the right to make changes without further notice to a product or system described herein to improve reliability, function or design. With respect to Avenview products which this document relates, Avenview disclaims all express or implied warranties regarding such products, including but not limited to, the implied warranties of merchantability, fitness for a particular purpose, and non-infringement.