

### Welcome!

We greatly appreciate your purchase of the SC206-204/205 Passive Unbalanced to Balanced Audio Adapter. We are sure you will find it reliable and simple to use. Superior performance for the right price, backed by solid technical and customer support is what ALTINEX has to offer.

We are committed to providing our customers with Signal Management Solutions® to the most demanding audiovisual installations at very competitive pricing and we welcome you to join the ranks of our many satisfied customers throughout the world.

### 1. Precautions and Safety Warnings

Please read this manual carefully before using your SC206-204/205. Keep this manual handy for future reference. These safety instructions are to ensure the long life of your SC206-204/205 and to prevent fire and shock hazards. Please read them carefully and heed all warnings.

#### 1.1 General

- Qualified ALTINEX service personnel or their authorized representatives must perform all service.

#### 1.2 Installation Precautions

- To prevent fire or shock, do not expose this unit to water or moisture. Do not place the SC206-204/205 in direct sunlight, near heaters or heat-radiating appliances, or near any liquid. Exposure to direct sunlight, smoke, or steam can harm internal components.
- Handle the SC206-204/205 carefully. Dropping or jarring can cause damage.
- Do not pull any cables that are attached to the SC206-204/205.
- Insert the card carefully into the slots of the MultiTasker without bending any edges.

### 2. Installation Procedures

Step 1. Connect the input side of the SC206-204/205 to the output of the audio source. The audio source could be a sound card, VCR, DVD player, etc.

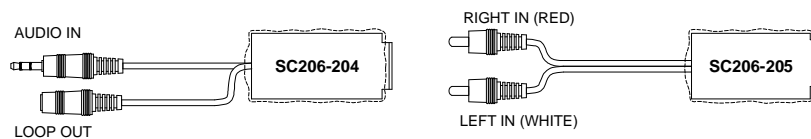

Step 2. Wire the audio cables from the receiving device (amplifier, speakers, etc.) to the terminal block connectors provided with the unit.

Step 3. Connect the terminal block connector to the output of the SC206-204/205.

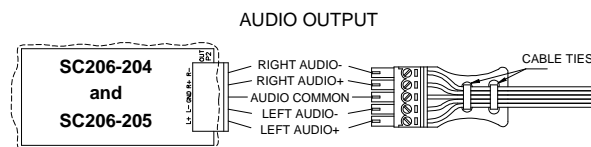

Step 4. The adapter is now operational. Verify the sound quality on the receiving end is equivalent to the input source.

### 3. Limited Warranty/Return policies

Please see the ALTINEX website at [www.altinex.com](http://www.altinex.com) for details on warranty and return policies.

### 1.3 Cleaning

- Clean only the connector area with a dry cloth. Never use strong detergents or solvents such as alcohol or thinner. Do not use a wet cloth or water to clean the card. Do not clean or touch any component or PCB.

### 1.4 FCC Notice

- This device complies with Part 15 of the FCC Rules. Operation is subject to the following two conditions: (1) This device may not cause harmful interference, and (2) this device must accept any interference received, including interference that may cause undesired operation.
- This equipment has been tested and found to comply with the limits for a Class A digital device, pursuant to Part 15 of the FCC Rules. These limits are designed to provide reasonable protection against harmful interference when the equipment is operated in a commercial environment. This equipment generates, uses, and can radiate radio frequency energy and, if not installed and used in accordance with the instructions found herein, may cause harmful interference to radio communications. Operation of this equipment in a residential area is likely to cause harmful interference in which case the user will be required to correct the interference at his own expense.
- Any changes or modifications to the unit not expressly approved by ALTINEX, Inc. could void the user's authority to operate the equipment.

### 4. Technical Specifications

Specifications are subject to change. See [www.altinex.com](http://www.altinex.com) for up-to-date information.

Features/Description	SC206-204/205
Inputs	
SC206-204	3.5 mm male (1)
SC206-205	RCA male (2)
Outputs	
SC206-204 Main Output	5-pin terminal block (1)
SC206-204 Local Output	3.5 mm female (1)
SC206-205	5-pin terminal block (1)
Compatibility	
SC206-204	Standard PC Application or Home Theater
SC206-205	
Accessories Included	
Output mating connector	5-pin terminal block (1)

Table 1. SC206-204/205 General

Mechanical	SC206-204/205
Material	FP-301 tubing
Color	Clear
Height	0.8 in (20 mm)
Width	1.3 in (33 mm)
Depth	2.5 in (64 mm)
Weight	0.2 lb (0.1 kg)
Shipping Weight (approx.)	0.6 lb (0.3 kg)
T° Operating	10°C to 40°C
T° Maximum	0°C to 50°C
Humidity	90% non-condensing
MTBF (calculations)	40,000 hrs

Table 2. SC206-204/205 Mechanical

Electrical	SC206-204/205
Input Signals	
Impedance	600 Ω
Max Level	3 dBu
Output Signals	
Gain*	0 dB +/- 0.3 dB
Impedance	600 Ω
Response	200 Hz-15 kHz
Max Power	100 mW

Table 3. SC206-204/205 Electrical

\* The gain is as measured at the output of a high impedance differential receiver.

### 5. About Your SC206-204/205

The SC206-204 and SC206-205 are audio adapters that convert unbalanced audio signals to balanced audio. The converted signals provide better sound quality and greatly reduce noise over long transmission lengths. Both units are passive devices and may be used to convert balanced signals to unbalanced signals as well.

The SC206-204 is designed to convert a standard computer audio output to balanced audio. It has excellent bandwidth and is ideal for most commercial-user applications. Since the SC206-204 is a passive device, there is no need for an external power source. Simply make the audio connections and it is ready to go.

The SC206-205 is also a passive device and is designed to convert unbalanced audio output from computers, DVD players, VCRs, etc. to balanced audio. The SC206-205 possesses superior bandwidth, and is perfect for home theaters and marketing/sales presentation applications.

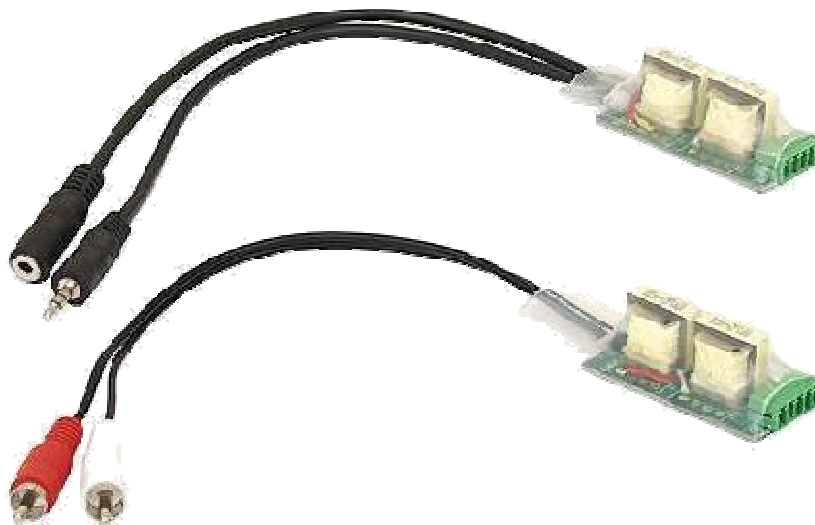
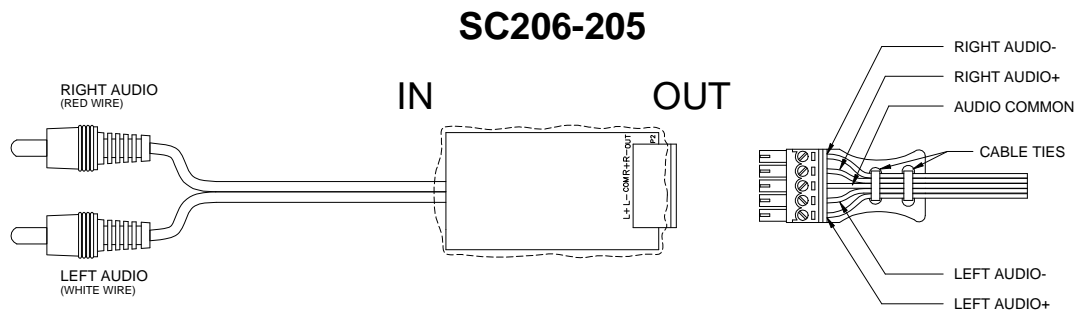
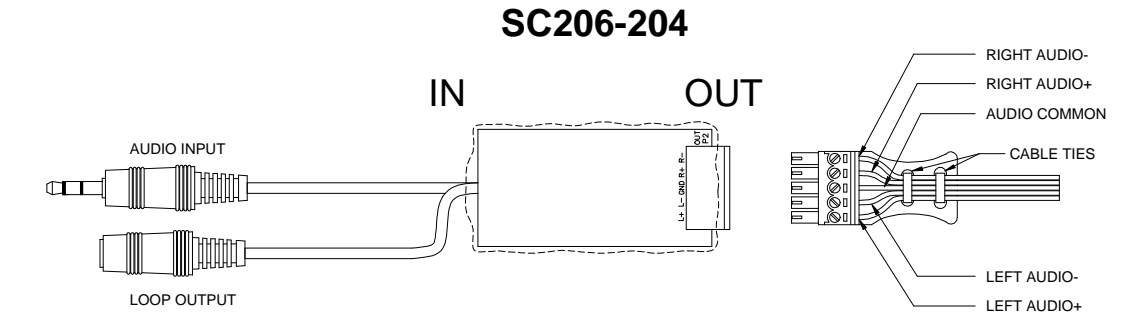

### 6. Application Diagrams

Diagram 1: Typical Setup

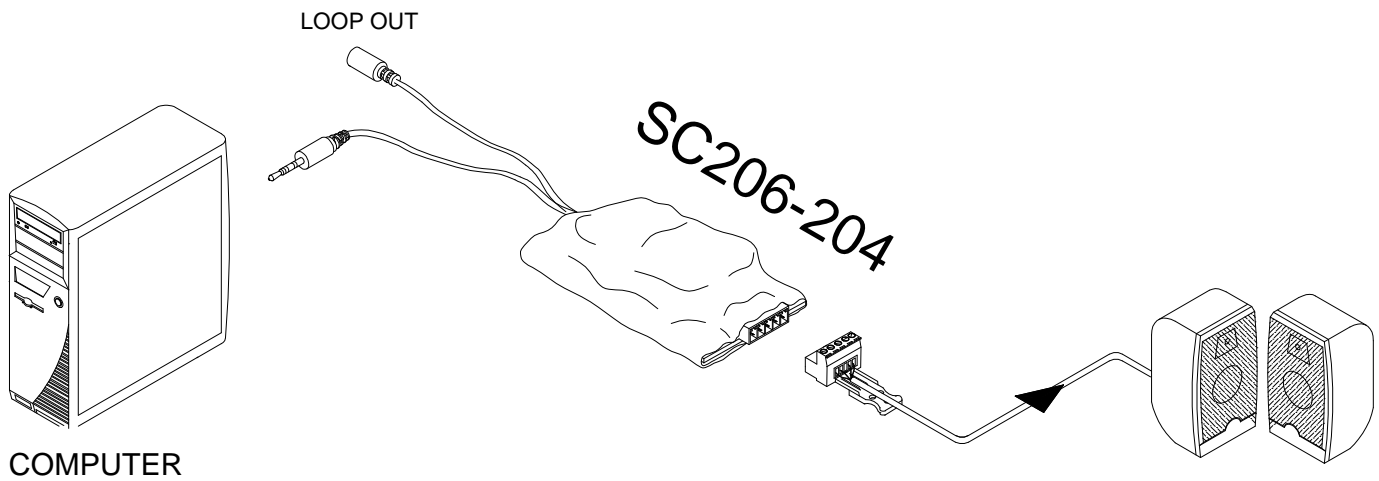

COMPUTER

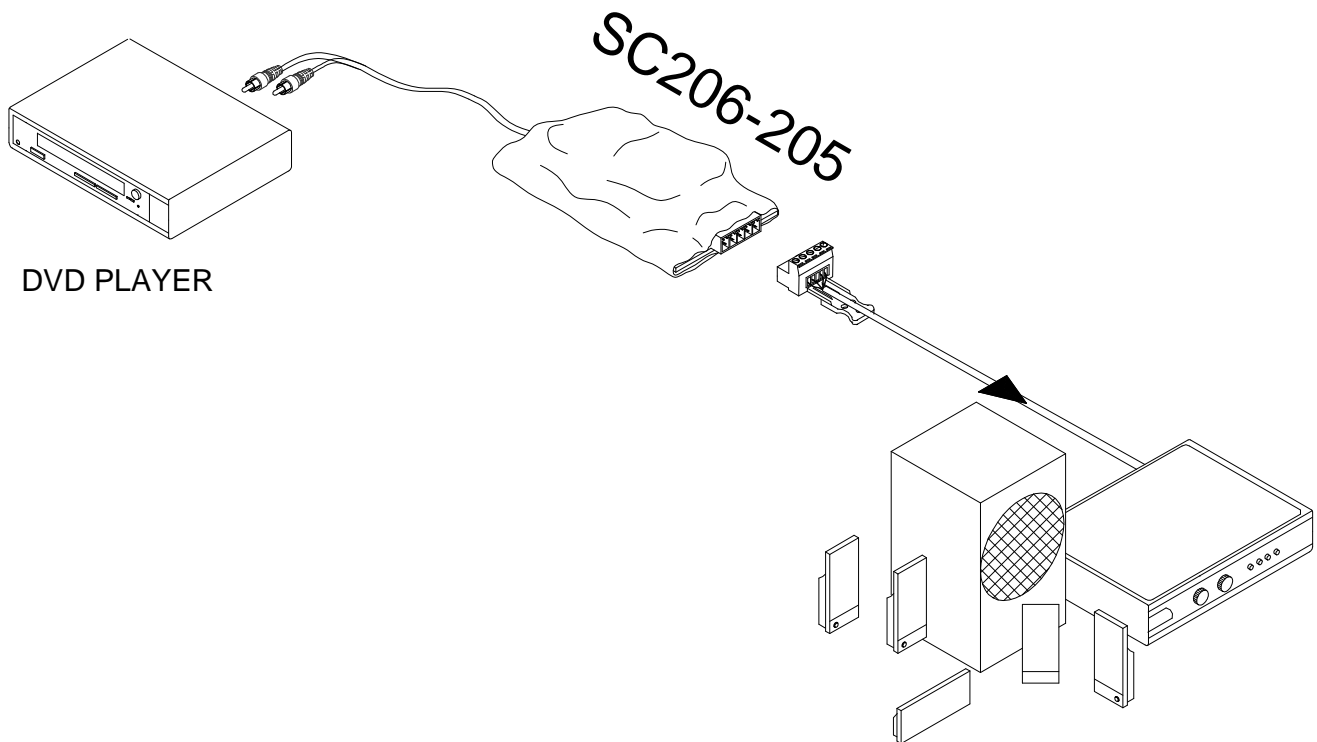

DVD PLAYER

Diagram 2: Internal View

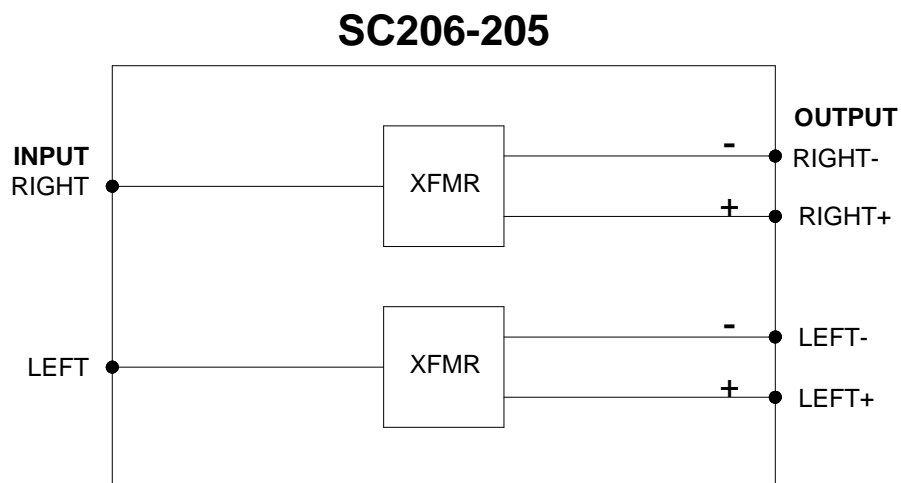
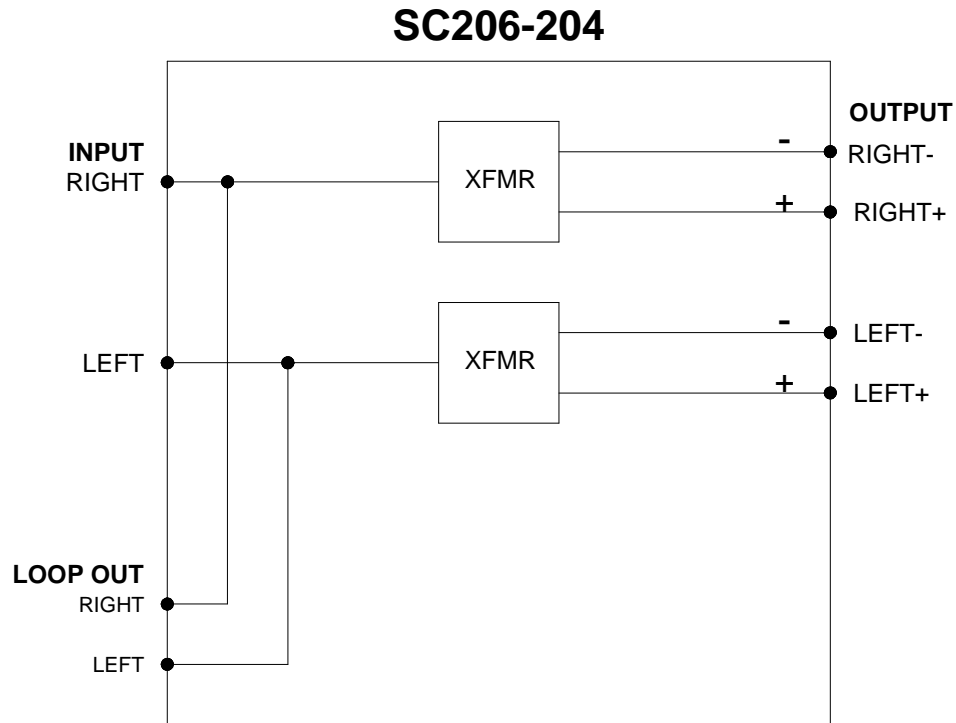

### 7. Operation

The SC206-204/205 requires no adjustments for optimum performance. Once set up, the SC206-204/205 will work trouble-free without user intervention.

### 8. Troubleshooting

We have carefully tested and found no problems in the supplied SC206-204/205. However, we would like to offer suggestions for the following:

#### 8.1 No Remote Sound

**Cause 1:** The source has a problem.

**Solution:** Connect the output of the PC directly to the speakers and verify the quality is good. If the sound is good, see Cause 2.

**Cause 2:** The cable connections are wrong.

**Solution:** Verify the input of the SC206-204/205 is connected to the output of the source and that the output is properly wired to the receiving device.

**Solution 2:** Remove the SC206-204/205 from the setup, but connect the source to the receiver using all the same cables.

**Solution 3:** If there is still no sound, there may be a problem with the SC206-204/205. Please call ALTINEX at (714) 990-2300.