

RFL Series AV

Raised Access Floor Boxes



FSR

Metal Products Group

RFL-AV Floor Boxes

RFL-QAV-CLYDD

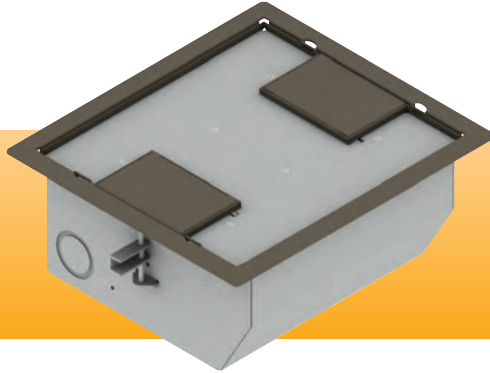

RFL-QAV-BLK

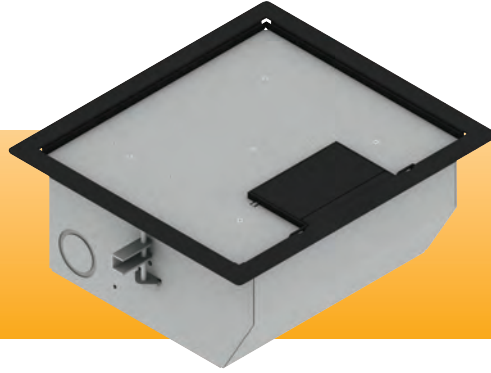

RFL-DAV-SLGRY

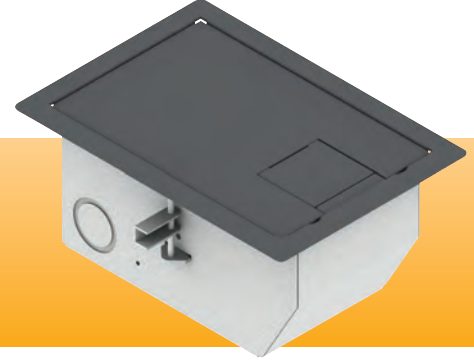

DESCRIPTION

The RFL-AV floor boxes are perfect for applications with raised floors that require AV and power in one box. AV connections require additional space behind the connector plate to accommodate interfaces, connectors and large cable radii. These boxes handle that and more!

The "Q" model is the larger version and accepts any two plate combinations equalling four gang. An optional 4-gang bracket is available for applications requiring a four gang plate.

The "D" model is a small, compact unit that accepts a 2-gang plate, and is supplied with a divider bracket to create 1-gang of high voltage and 1-gang of low voltage compartments.

Covers and carpet trims are available in gray, black and clay. If your application requires a custom color, FSR will be happy to quote on your specific requirements.

You have a choice of covers with the RFL-AV Series. If you are using carpeting, select the dual door or single door covers. If you have a floor where you don't want to insert the carpet on the top of the box, select the solid cover door. (Note: the RFL-DAV is only available in the single door for carpet, or the solid cover door.)

The back boxes are 5" deep, and are constructed of 14-gauge steel.

FEATURES

- 14 gauge steel construction throughout
- Oversized cable door
- Standard electrical plate openings on all models
- Superior mounting clamp design to handle a wide variety of floor thicknesses
- Multiple knockouts in a variety of sizes
- Listed by UL to meet US and Canadian safety standards

APPLICATIONS

- Raised Access Floors in Office Buildings
- Churches • Conference Centers • Museums
- Schools • General Meeting Facilities

Optional Brackets for RFL-QAV

- 59009 BRACKET ONLY
(one included) order additional as needed
- 59011 DIVIDER ONLY
(one included) order additional as needed
- 59012 BRACKET COVER
(one included) order additional as needed
- 11429 $\frac{6}{32} \times \frac{1}{4}$ " PAN HEAD SCREW
(one included) order additional as needed
- 16237 4-GANG BRACKET KIT COMPLETE
with 3 dividers and hardware
- 16520 EXTRON AAP104 BRACKET KIT COMPLETE
with hardware

FSR Inc.

244 Bergen Boulevard, Woodland Park, NJ 07424
Phone: 973.785.4347 · Fax: 973.785.4207
Web: www.fsrinc.com · E-mail: sales@fsrinc.com

LIT1109C

RFL-AV Cover Dimensions

RFL-DAV Cover

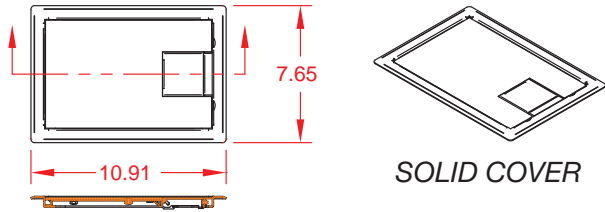
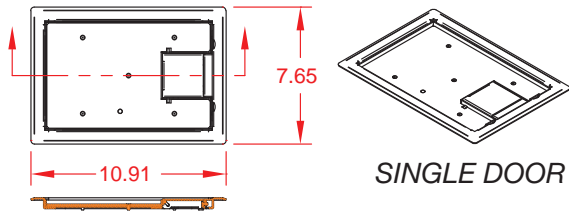

RFL-QAV Cover

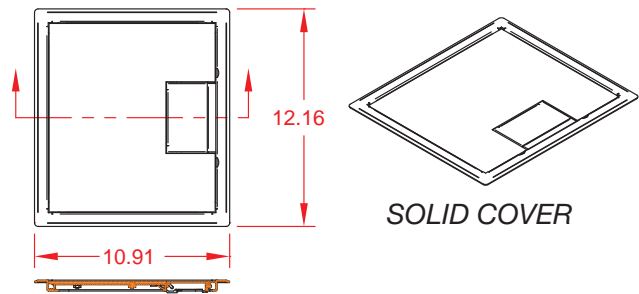
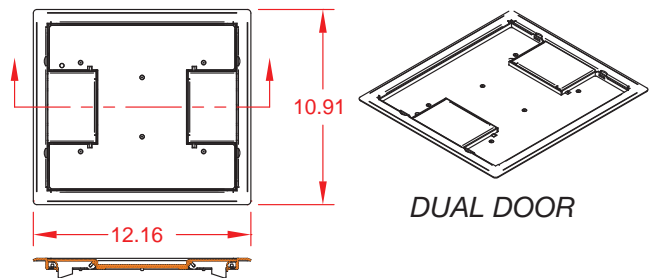
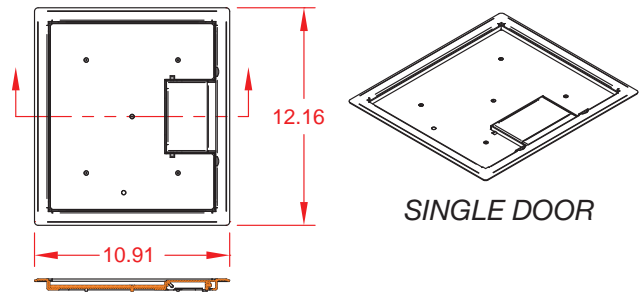

RFL-DAV General Dimensions

RFL-DAV

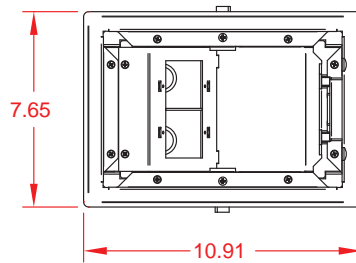
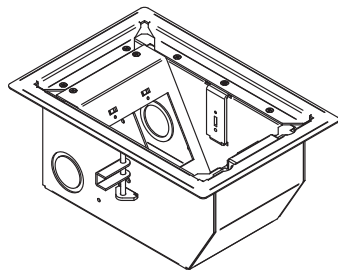

9.75 x 6.50
FLOOR HOLE SIZE

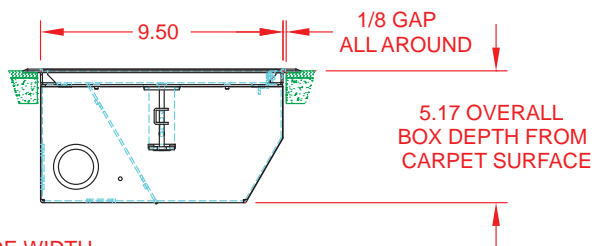
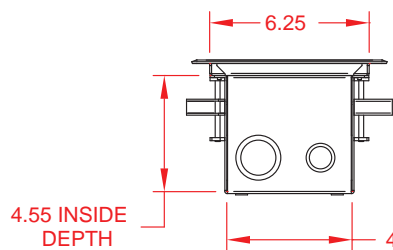

RFL-QAV General Dimensions

RFL-QAV

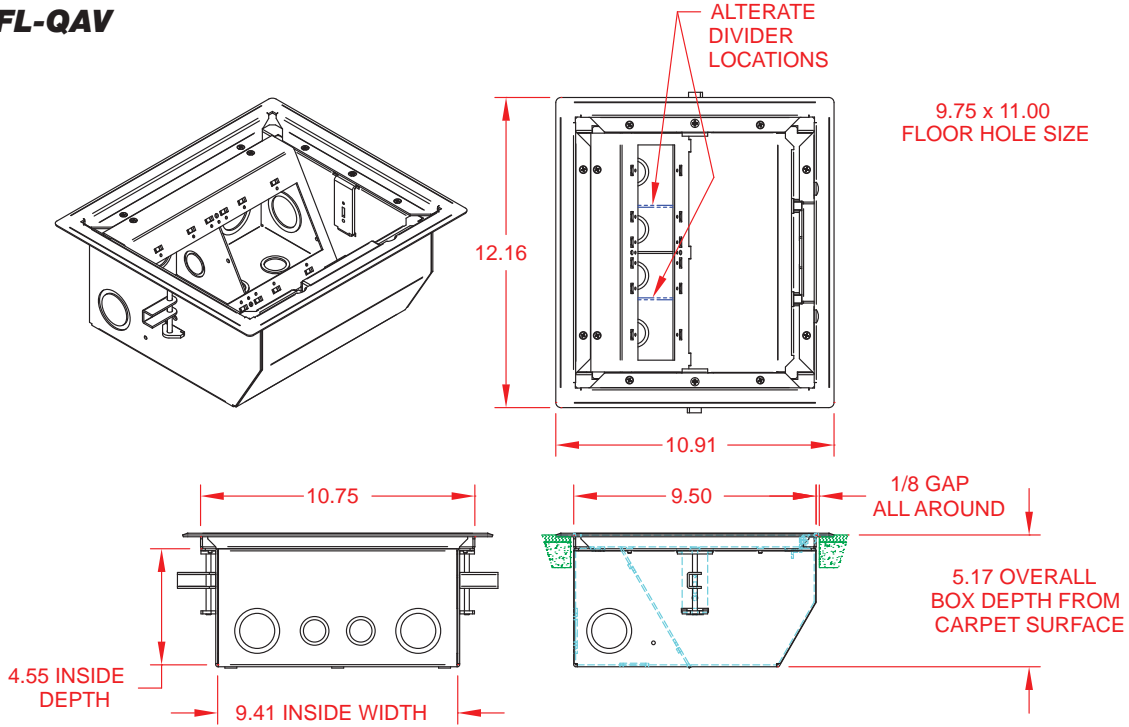

Drawings are not to scale

RFL-QAV Accessory Brackets

RFL-QAV ALTERNATE DIVIDER LOCATIONS

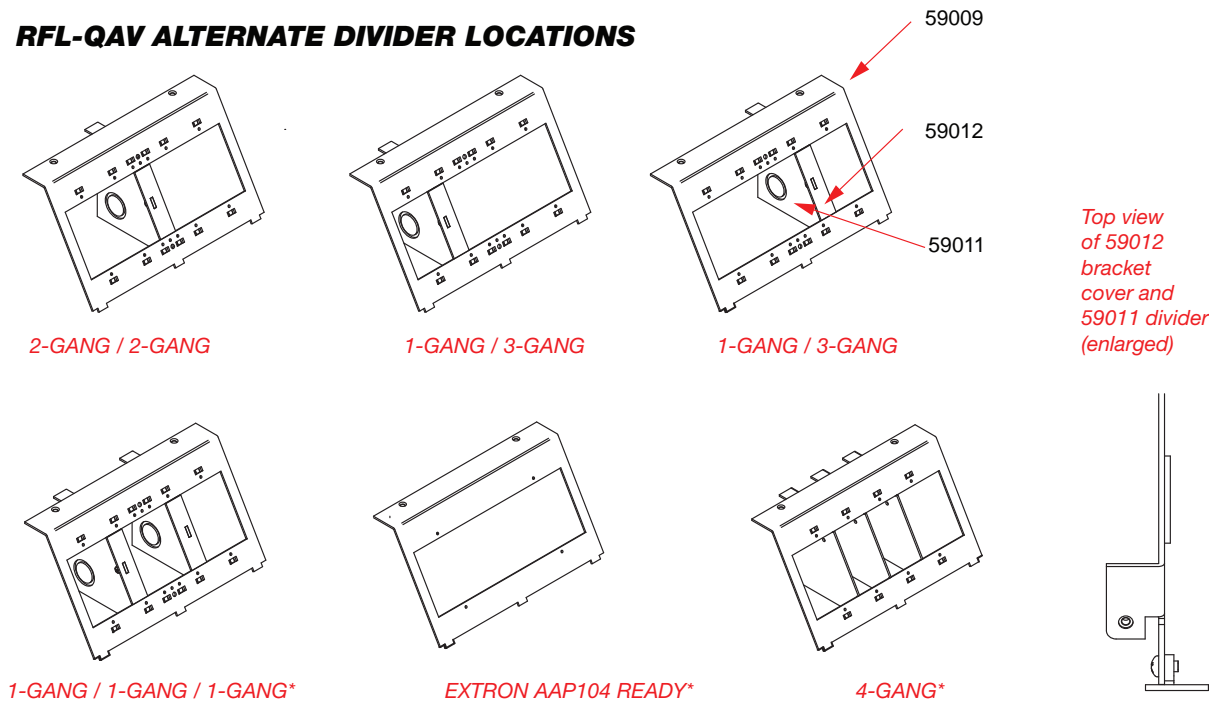

* indicates additional brackets and hardware required

RFL SERIES AV ORDERING INFORMATION

ITEM #	PART#	DESCRIPTION
Carpet Trim Cover with Single Door with 2-Gang Opening		
16226	RFL-DAV-GRY	RFL-AV 2 Gang Box with Gray Trim
16222	RFL-DAV-BLK	RFL-AV 2 Gang Box with Black Trim
16224	RFL-DAV-CLY	RFL-AV 2 Gang Box with Clay Trim
Solid Cover with Single Door with 2 Gang Opening		
16227	RFL-DAV-SLGRY	RFL-AV 2 Gang Box with Solid Cover - Gray
16223	RFL-DAV-SLBLK	RFL-AV 2 Gang Box with Solid Cover - Black
16225	RFL-DAV-SLCLY	RFL-AV 2 Gang Box with Solid Cover - Clay
Carpet Trim Cover with Single Door 3 + 1 Gang Opening and Positional Divider		
16234	RFL-QAV-GRY	RFL-AV 3 + 1 Gang Box with - Gray Trim
16228	RFL-QAV-BLK	RFL-AV 3 + 1 Gang Box with - Black Trim
16231	RFL-QAV-CLY	RFL-AV 3 + 1 Gang Box with - Clay Trim
Carpet Trim Cover with Dual Door 3 + 1 Gang Opening and Positional Divider		
16236	RFL-QAV-DDGRY	RFL-AV 3 + 1 Gang Box with Dual Door Cover - Gray
16230	RFL-QAV-DDBLK	RFL-AV 3 + 1 Gang Box with Dual Door Cover - Black
16233	RFL-QAV-DDCLY	RFL-AV 3 + 1 Gang Box with Dual Door Cover - Clay
Solid Cover with Single Door 3 + 1 Gang Opening and Positional Divider		
16235	RFL-QAV-SLGRY	RFL-AV 3 + 1 Gang Box with Solid Cover - Gray
16229	RFL-QAV-SLBLK	RFL-AV 3 + 1 Gang Box with Solid Cover - Black
16232	RFL-QAV-SLCLY	RFL-AV 3 + 1 Gang Box with Solid Cover - Clay
RFL-QAV Accessories		
59009	BRACKET ONLY (one included) order additional as needed	
59011	DIVIDER ONLY (one included) order additional as needed	
59012	BRACKET COVER (one included) order additional as needed	
11429	$\frac{9}{32} \times \frac{1}{4}$ " PAN HEAD SCREW (one included) order additional as needed	
16237	4-GANG BRACKET KIT COMPLETE with 3 dividers and hardware	
16520	EXTRON AAP104 BRACKET KIT COMPLETE with hardware	

Similar FSR Products

The **RFL Series Q** raised access floor boxes are designed for installation applications where higher capacity is required. These large multi-compartment boxes have ample room for power, video, audio, data and more. They are available in two depths, two gang layout styles with removable dividers to isolate power and create different gang arrangements. See RFL Series Q spec sheet for details.

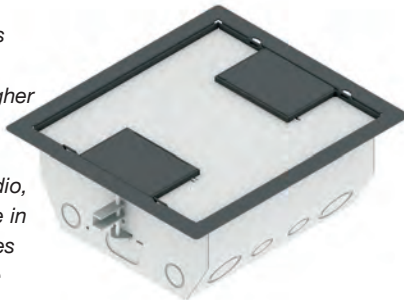

RFL4.5-Q2G-BLKDD

The **RFL Series D** raised access floor boxes come in two box depths and three gang layout styles. They offer compartments on opposite sides on the RFL3 and compartments on 2 sides and bottom on the RFL4.5 models. See RFL Series D spec sheet for details.

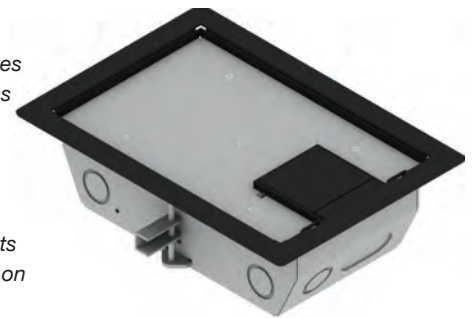

RFL3-D1G-BLK



Specifications are subject to change without notice.
©2020 FSR Inc. All Rights Reserved.

FSR

244 Bergen Boulevard, Woodland Park, NJ 07424
Phone: 973.785.4347 · Fax: 973.785.4207
Web: www.fsrinc.com · E-mail: sales@fsrinc.com