

OPERATION MANUAL

MFR-3000

Multi Format Routing Switcher

MFR-30FP

MFR-18/39RUA

MFR-16/18/39/40RU

MFR-16RUD

MFR-16/32/64RUW

MFR-16RUTA

MFR-GPI

MFR-TALM

6th Edition

Edition Revision History

Edit.	Rev.	Date	Description	Section/Page
1	-	2015/02/27		
2	-	2015/05/27	MFR-30FP added.	Sec. 4
2	1	2015/09/16	Switcher's AUX Crosspoints Switching	Sec. 3-4
3	-	2015/11/19	MFR-18/39RUA supported.	
4	-	2016/06/17	Audio cards supported. (MFR-8AAI/8AAO/8AESI/8AESO)	Secs. 1, 2-1-1, 2-3, 2-5, 9-1
5	-	2016/08/18	MFR-16MV supported. Page button operation added	Secs. 2, 7, 10 Appendix
6	-	2017/03/01	12G-SDI (MFR-8SDIGB / 8SDOGB) supported.	2-1, 2-3, 2-4, 8

Firmware / Software Versions and Supported Hardware / Features

Main Unit Firmware Version (*1)	GUI Version (*2)	Supported Hardware	Supported Feature
MFR-3000			
1.79 or higher	1.86 or higher	-	Switcher's AUX Crosspoints Switching
1.83 or higher	2.01 or higher	MFR-8SDIGB MFR-8SDOGB	Gearbox feature





(*1) Click [Primary CPU] in the [Web-based Control: System Settings- MU Info page] to see your version number under Firmware Version.

(*2) The GUI (Web-based control software) version is displayed on the browser's title bar.



Precautions

Important Safety Warnings



[Power]

 Caution	Operate unit only at the specified supply voltage.
	Disconnect the power cord via the power plug only. Do not pull on the cable portion.
 Stop	Do not place or drop heavy or sharp-edged objects on the power cord. A damaged cord can cause fire or electrical shock hazards. Regularly check the power cord for excessive wear or damage to avoid possible fire / electrical hazards.
 Caution	Ensure the power cord is firmly plugged into the AC outlet.

[Grounding]

 Caution	Ensure the unit is properly grounded at all times to prevent electrical shock.
 Hazard	Do not ground the unit to gas lines, units, or fixtures of an explosive or dangerous nature.



[Operation]

 Hazard	Do not operate the unit under hazardous or potentially explosive atmospheric conditions. Doing so could result in fire, explosion, or other hazardous results.
 Hazard	Do not allow liquids, metal pieces, or other foreign materials to enter the unit. Doing so could result in fire, other hazards, or a unit malfunction.
	If a foreign material does enter the unit, turn the power off and immediately disconnect the power cord. Remove the material and contact an authorized service representative if damage has occurred.

[Transportation]

 Caution	Handle with care to avoid impact shock during transit, which may cause malfunction. When you need to transport the unit, use the original or suitable alternative packing material.
--	--

[Circuitry Access]

	<p>Do not remove covers, panels, casing, or access the circuitry with power applied to the unit. Turn the power off and disconnect the power cord prior to removal. Internal servicing / adjustment of unit should only be performed by qualified personnel.</p>
 <p>Stop</p>	<p>Do not touch any parts / circuitry with a high heat factor. Capacitors can retain enough electric charge to cause mild to serious shock, even after the power has been disconnected. Capacitors associated with the power supply are especially hazardous.</p>
 <p>Hazard</p>	<p>Unit should not be operated or stored with cover, panels, and / or casing removed. Operating the unit with circuitry exposed could result in electric shock / fire hazards or a unit malfunction.</p>

[Potential Hazards]

 <p>Caution</p>	<p>If abnormal odors or noises are noticed coming from the unit, immediately turn the power off and disconnect the power cord to avoid potentially hazardous conditions. If problems similar to the above occur, contact an authorized service representative before attempting to operate the unit again.</p>
--	---

[Rack Mount Brackets, Ground Terminal, and Rubber Feet]

 <p>Caution</p>	<p>To rack-mount or ground the unit, or to install rubber feet, do not use screws or materials other than those supplied. Doing so may cause damage to the internal circuits or components of the unit. If you remove the rubber feet that are attached to the unit, do not reinsert the screws that secure the rubber feet.</p>
--	--

[Consumables]

 <p>Caution</p>	<p>Consumable items that are used in the unit must be periodically replaced. For further details on which parts are consumables and when they should be replaced, refer to the specifications at the end of the Operation Manual. Since the service life of the consumables varies greatly depending on the environment in which they are used, such items should be replaced at an early date. For details on replacing consumable items, contact your dealer.</p>
--	---

Upon Receipt

Unpacking

MFR-3000 units and their accessories are fully inspected and adjusted prior to shipment. Operation can be performed immediately upon completing all required connections and operational settings.

Check your received items against the packing lists below. Check to ensure no damage has occurred during shipment. If damage has occurred, or items are missing, inform your supplier immediately.

◆ Main Unit

ITEM	QTY	REMARKS
MFR-3000	1	
AC Cord	1 set	AC cable and retaining clip
Rack Mount Brackets	1 set	EIA standard type (Attached to unit.)
Rubber Feet	4	
CD-ROM	1	Operation manual (PDF)
Notes on serial port setting	1	
Quick Setup Guide	1	

◆ Input / Output Cards

ITEM	QTY	REMARKS
MFR-8SDI	1 - 8 *	8 SDI input card
MFR-8SDO	1 - 8 *	8 SDI output card
MFR-8AAI	1 - 8 *	Analog audio input card with A/D converter (Analog 8 stereo pairs)
MFR-8AAO	1 - 8 *	Analog audio output card with D/A converter (Analog 8 stereo pairs)
MFR-8AESI	1 - 8 *	AES audio input card (AES/EBU 8 stereo pairs)
MFR-8AESO	1 - 8 *	AES audio output card (AES/EBU 8 stereo pairs)
MFR-16MV	1 - 4 *	16 SDI output card with multiviewer function.
MFR-8SDIGB	1 - 8 *	SDI input card (Gearbox 2ch built-in)
MFR-8SDOGB	1 - 8 *	SDI output card (Gearbox 2ch built-in)

* The number of installed cards varies depending on the system configuration. See the Matrix Size Chart on page 14

◆ Remote Control Panel

ITEM	QTY	REMARKS
MFR-18RUA/39RUA MFR-39RU/40RU/18RU MFR-16RU/16RUD/16RUTA MFR-16/32/64RUW	1	
AC Adaptor ^(*)	1	With DC lock plug (MFR-40RU/39RUA/18RUA)
AC cable	1	
DC cable retaining clip	1 set	For AC adapters w/o DC lock plug
Rack Mount Brackets	1 set	EIA standard type (MFR-16/32/64RUW/16RUTA is supplied w/o Rack Mount Brackets.)
Tool used to change button labels	1	

LAN Cable (straight) (*2)	1	MFR-39/40/18RU/16RUTA/18RUA/39RUA: UTP cable, 5m MFR-16RU/16RUD: STP cable, 5m (MFR-16/32/64RUW is supplied w/o LAN Cable)
---------------------------	---	---

(*1) Depending on the production date, AC adapter is supplied without DC lock plug, but with a DC cable retaining clip.

(*2) User-prepared LAN cables are also available and Shielded Twist Pair cables are recommended for MFR-16RU/16RUD/16RUW/32RUW/64RUW.

◆ Options (for MFR-3000)

ITEM	QTY	REMARKS
MFR-30CPU	1	Redundant CPU card *
MFR-30PS	1 set	Redundant power supply unit (with AC cord and AC cord retaining clip.)
MFR-30FP	1	Front control panel

◆ Interface Expansion Unit

ITEM	QTY	REMARKS
MFR-GPI	1	
AC Adaptor *	1	With DC lock plug
AC cable	1	
Rack Mount Brackets	1 set	EIA standard type
LAN Cable (straight)	1	

* Depending on the production date, AC adapter is supplied without DC lock plug, but with a DC cable retaining clip.

◆ Tally Manager Unit

ITEM	QTY	REMARKS
MFR-TALM	1	
AC Adaptor *	1	With DC lock plug
AC cable	1	
Rack Mount Brackets (optional)	1 set	Single- or Dual-unit type, EIA standard type

* Depending on the production date, AC adapter is supplied without DC lock plug, but with a DC cable retaining clip.

Installing the AC Cord Retaining Clip (Main Unit)

Secure the AC cord with the supplied AC cord retaining clip to prevent accidental removal from the unit.

Procedure

- 1) Securely plug the AC cord into the AC connector.
- 2) Attach the retaining clip on to the side of the AC cord.
- 3) Thread both ends of the retaining clip into the holes of the retaining clip base attached on the unit.

Installing the DC Cable Retaining Bracket

Install the supplied retaining bracket onto the rear panel of devices, such as a Control Unit as shown below.

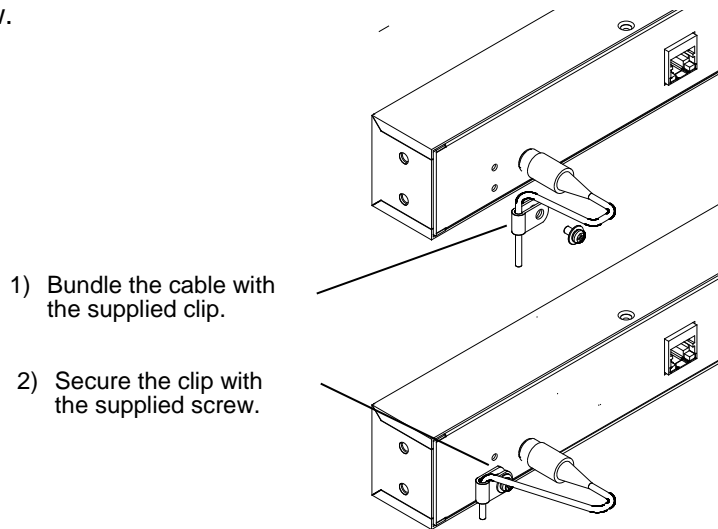

Font Conventions

The following conventions are used throughout this manual:

- Shaded text (such as **ON**) indicates **parameter values** in the menu.
- Text enclosed by a square (such as **ALARM**, **MODE**) indicates **front panel buttons** on the MFR-3000 or Remote Control Units.
- References to the MFR Series Web-based Control Software are indicated by [Web-based Control: XXX page].

Table of Contents

1. Prior to Starting.....	13
1-1. Welcome	13
1-2. Features	13
2. Panel Descriptions	14
2-1. MFR-3000 Front Panel.....	14
2-1-1. Matrix Size Chart.....	14
2-2. MFR-30FP Front Panel	16
2-3. MFR-3000 Rear Panel	17
2-3-1. Interfaces.....	19
2-3-2. SDI Input/Output Cards.....	21
2-3-3. CPU Card Installation and Removal	21
2-3-4. Changing the Interface from RS-422 to RS-232C	23
2-4. SDI Input / Output Cards.....	24
2-4-1. MFR-8SDI	24
2-4-2. MFR-8SDO	24
2-4-3. MFR-16MV	25
2-4-4. MFR-8SDIGB.....	25
2-4-5. MFR-8SDOGB	26
2-5. Audio Input / Output Cards.....	27
2-5-1. MFR-8AAI (Analog Input).....	27
2-5-2. MFR-8AAO (Analog Output).....	28
2-5-3. MFR-8AESI (AES Input)	30
2-5-4. MFR-8AESO (AES Output).....	30
2-6. Remote Control Panel.....	31
2-6-1. Front Panel.....	31
2-6-2. Rear Panel	35
2-7. MFR-GPI	36
2-7-1. Front Panel.....	36
2-7-2. Rear Panel	37
2-7-3. Interfaces (MFR-GPI).....	38
2-7-4. Switches on the Card	40
2-8. MFR-TALM.....	41
2-8-1. Front Panel.....	41
2-8-2. Rear Panel	42
3. System Configuration Example.....	43
3-1. Basic Configuration	43
3-2. Main Unit Linking.....	44
3-2-1. Parallel Link System Example	44
3-2-2. Expanded Matrix System Example.....	45
3-3. Signal Name and Tally Link System	46
3-3-1. Standard Configuration	46
3-3-2. If Configuring an MFR-TALM.....	48
3-4. Switcher's AUX Crosspoints Switching System.....	51
3-4-1. Switching an AUX Bus Signal	51
3-4-2. Synchronous Crosspoints Switching	53

4. Front Panel (MFR-30FP) Operation.....	54
4-1. Functions and Operations.....	54
4-2. Basic Operation on the Front Panel.....	55
4-2-1. Buttons.....	55
4-2-2. Page Function.....	55
4-2-2-1. Group Page Changes.....	55
4-3. Function Buttons.....	57
4-4. Operation Using the Menu Display.....	58
4-4-1. Destination menu.....	58
4-4-2. Source menu.....	59
4-4-3. Crosspoint menu.....	59
4-4-4. Button Assign menu.....	60
4-4-5. Button Group menu.....	61
4-4-6. Setting menu.....	61
4-4-6-1. BRIGHTNESS.....	62
4-4-6-2. MFR-LAN.....	62
4-4-6-3. PC-LAN.....	63
4-4-6-4. ALARM.....	63
5. Remote control panel Operation.....	64
5-1. Functions and Operations.....	64
5-2. Basic Operation on Control Panels.....	65
5-2-1. Buttons.....	65
5-2-2. Page Function.....	65
5-2-2-1. Group Page Changes.....	66
5-2-3. Control Knob.....	68
5-3. Function Buttons.....	70
5-4. MODE Button and Mode Menu (MFR-39RU/18RU/16RUTA/39RUA/18RUA).....	73
5-4-1. Outline.....	73
5-4-2. Mode Menu.....	73
5-4-3. Setting Mode Menu (MFR-39RU).....	76
5-4-3-1. DEF MODE.....	76
5-4-3-2. DEF DEST.....	77
5-4-3-3. DEF LEVEL.....	77
5-4-3-4. PAGE MODE.....	77
5-4-3-5. PAGE ASSIGN.....	77
5-4-3-6. DSTINHIBIT.....	78
5-4-3-7. SRCINHIBIT.....	78
5-4-3-8. NAME TYPE.....	79
5-4-3-9. TENKEY MOD.....	79
5-4-3-10. TENKEY NO.....	79
5-4-3-11. SALVO CLR.....	80
5-4-3-12. BTN ASSIGN.....	80
5-4-4. Setting Mode Menu (MFR-39RUA).....	82
5-4-4-1. NETWORK.....	82
5-4-4-2. VER/ALARM.....	83
5-4-4-3. DEFAULT.....	83
5-4-4-4. BUTTON ASSIGN.....	84
5-4-4-5. INHIBIT.....	85

5-4-4-6. NAME TYPE	85
5-4-4-7. BRIGHTNESS.....	86
5-4-4-8. RU-RU CONNECT.....	86
5-4-4-9. TENKEY.....	86
5-4-4-10. PAGE	86
5-4-4-11. SALVO CLEAR.....	86
5-5. Operation Using the Menu Display (MFR-16RUD).....	87
5-5-1. Crosspoint Switching	87
5-5-2. Button Assignment Change	88
5-6. Setup Menu (MFR-39RU)	90
5-6-1. IP ADDRESS[RU]	90
5-6-2. SUBNET MASK[RU]	91
5-6-3. PC-LAN[MU]	91
5-6-4. RU CONN ID.....	91
5-6-5. RU CONNECT	92
5-6-6. BRIGHTNESS.....	92
5-6-7. BTN ASSIGN	92
5-6-8. VER/ALARM	92
5-6-9. REBOOT	92
5-7. Setup Menu (MFR-39RUA).....	93
5-8. Setup Menu (MFR-18RU/18RUA)	93
5-8-1. Displaying Network Settings.....	93
5-8-2. Changing the RU Network Settings	93
5-8-3. Rebooting MU PC-LAN.....	94
5-9. Setup Menu (MFR-16RUTA).....	95
5-9-1. Displaying Network Settings.....	95
5-9-2. Changing the RU Network Settings	96
5-9-3. Rebooting MU PC-LAN.....	96
5-10. Setup Menu (Other Remote Control Units).....	97
5-10-1. Displaying Network Settings.....	98
5-10-2. Changing the RU IP Address.....	99
5-10-3. Rebooting MU PC-LAN.....	100
5-11. Multi-Panel Operation	101
5-11-1. Outline.....	101
5-11-2. Enabling Multi-Panel Operation	102
6. Crosspoint Control.....	103
6-1. One Crosspoint Switching.....	103
6-1-1. One Crosspoint Switching by X-Y Setting	103
6-1-1-1. SKIP-FWD/BWD.....	104
6-1-1-2. TENKEY (MFR-39RU/39RUA)	104
6-1-2. A Crosspoint Switching Using a Bus Button.....	105
6-1-3. CHOP Function	106
6-1-4. Crosspoint Switching Using TAKE Function.....	106
6-2. Simultaneous Crosspoint Switching.....	107
6-2-1. Main Unit Stored Salvos	107
6-2-2. Remote Control Stored Salvos	107
6-2-3. Front Panel Stored Salvos	109
6-2-4. Simultaneous Switching Using the Take Function	109

6-2-5. Simultaneous Switching by the Link Function	109
6-3. Lock	110
6-3-1. LOCK LOCAL.....	110
6-3-2. LOCK OTHER / LOCK ALL	111
6-4. Preview Function.....	113
6-5. Level Control	114
6-5-1. Level Indication on the Remote Control Panel	115
7. Multiview Output.....	116
7-1. Multiviewer Specifications.....	116
7-2. Displaying Multiview Images.....	117
7-3. Basic Rules for Creating Multiview Layouts.....	118
7-4. Clocks.....	118
7-5. Available Window Objects.....	119
8. Gearbox Feature (MFR-8SDIGB/8SDOGB)	120
8-1. MFR-8SDIGB / 8SDOGB Cards	120
8-2. Available Conversions.....	121
8-3. Conversion Settings	121
8-3-1. Converting 3G SQD Input to 2SI (MFR-8SDIGB)	121
8-3-2. Converting 2SI to SQD Output (MFR-8SDOGB).....	122
8-3-3. Converting 12G-SDI Input to 3G-SDI 2SI (MFR-8SDIGB).....	123
8-3-4. Converting 3G-SDI SQD to 12G-SDI Output (MFR-8SDOGB).....	123
9. Serial / LAN Command Control.....	124
9-1. Serial Interface	124
9-2. LAN Interface	124
9-3. Control Command	125
9-3-1. Command Responses (Commands 1-6)	126
9-3-2. Receiving Responses (Commands 1-6).....	127
9-3-3. Channel Name Request Commands (7).....	130
9-3-4. CPU Status Request Command (8).....	134
9-3-5. Destination Lock Status Request Command (9).....	135
10. Troubleshooting.....	136
10-1. Tuning the Text Color on Remote Unit Buttons.....	137
10-1-1. MFR-18RU/39RU Color Tuning Procedure	137
10-1-2. MFR-16RUTA/39RUA/18RUA Color Tuning Procedure	138
11. Specifications and Dimensions	139
11-1. Unit Specifications.....	139
11-1-1. MFR-3000	139
11-1-2. MFR-30FP	141
11-1-3. MFR-39RUA.....	141
11-1-4. MFR-39RU	141
11-1-5. MFR-40RU	142
11-1-6. MFR-18RUA.....	142
11-1-7. MFR-18RU	142
11-1-8. MFR-16RU/16RUD	143
11-1-9. MFR-16RUTA	143
11-1-10. MFR-16RUW.....	143

11-1-11. MFR-32RUW.....	144
11-1-12. MFR-64RUW.....	144
11-1-13. MFR-GPI.....	144
11-1-14. MFR-TALM.....	145
11-2. External Dimensions	146
11-2-1. MFR-3000	146
11-2-2. MFR-39RUA.....	147
11-2-3. MFR-39RU	147
11-2-4. MFR-40RU	148
11-2-5. MFR-18RUA.....	148
11-2-6. MFR-18RU	149
11-2-7. MFR-16RU	149
11-2-8. MFR-16RUD	150
11-2-9. MFR-16RUTA	150
11-2-10. MFR-16RUW.....	151
11-2-11. MFR-32RUW.....	151
11-2-12. MFR-64RUW.....	152
11-2-13. MFR-GPI.....	152
11-2-14. MFR-TALM.....	153
Appendix: Operation Tips.....	154
How to use Page buttons	154

1. Prior to Starting

1-1. Welcome

Congratulations! By purchasing an MFR-3000 Multi Format Routing Switcher (hereafter called MFR main unit) you have entered the world of FOR-A and its many innovative products. We thank you for your patronage and hope you will turn to FOR-A products again and again to satisfy your video and audio needs.

FOR-A provides a wide range of products, from basic support units to complex system controllers, which have been increasingly joined by products for computer video-based systems. Whatever your needs, talk to your FOR-A representative. We will do our best to be of continuing service to you.

1-2. Features

The MFR-3000 is a multi-format routing switcher that supports 12G-SDI, 3G-SDI, HD-SDI, SD-SDI, ASI, AES and Analog audio signals. Inside the 4U case a matrix of up to 64 inputs/64 outputs can be configured. And by linking multiple units, they can be used as a large-scale routing switcher. It supports various functions such as the capability of linking multiple cases, tally connections with peripheral devices, and automatic source name tracking, to allow the units to be the core product in small to medium size systems.

- Support for **3G-SDI, HD-SDI, SD-SDI**, and **ASI** signals with automatic signal recognition that enables operation without concern for the type of signal. **12G-SDI, AES** and **analog audio** input/output and **multiview output** are also supported by installing optional input/output cards.
- By linking multiple units, they can be used as a large-scale routing switcher.
- Up to **8 units** can be linked together for expansions of up to **128 x 64 – 192 x 21**.
- One routing switcher can be virtually partitioned to build any theoretical hierarchy, which creates possibilities for use in various operating forms.
- Various crosspoint control functions such as **Salvo, Take, Link, Level** operation, and **Chop**
- **Tally linking** with FOR-A's video switchers (HANABI Series) and multi viewers. Source name displays on video switchers and multi viewers can be switched in conjunction with switchings controlled in the main unit. MFR routers support TSL and Harris protocol, enabling linkage to other companies' products.
- Built-in web server for **remote control** through a web browser
- **SNMP support** enabling SNMP monitoring system configuration
- **Status monitoring** for power supply, fan, CPU, SDI input/output, etc.
- **CPU board redundancy** allowing monitoring of primary CPU board operation via the secondary board. Immediate and smooth switch over to the secondary board without down time in case of irregularities, as well as stable remote control operation supported by the **network redundancy**
- **Power unit redundancy** for stable power supply against power unit failure or power supply troubles
- Matrix partition and level setting capabilities support a flexible control environment (maximum of 128 units in total including the main unit)
- Remote control panel connectivity for configuring a huge control panel
- Interface expansion unit (**MFR-GPI**) for additional 128 (32 x 4) GPI/O and 4 serial ports (9-pin D-sub, male)
- **MFR-TALM** Tally Manager Unit is designed specifically to manage tally and signal name data in the MFR system and the exchange of this data with external devices such as a video switcher, multiviewer etc.. The unit performs the task of tally data computation, which is ordinarily undertaken by the MFR main unit, to accelerate the task.
- Front control panel option (**MFR-30FP**)
- Conversions between 12G-SDI and Quad Link 3G-SDI and between 2SI and SQD available by installing optional **MFR-8SDIGB** and **MFR-8SDOGB** (Gearbox feature built-in) cards.

2. Panel Descriptions

2-1. MFR-3000 Front Panel

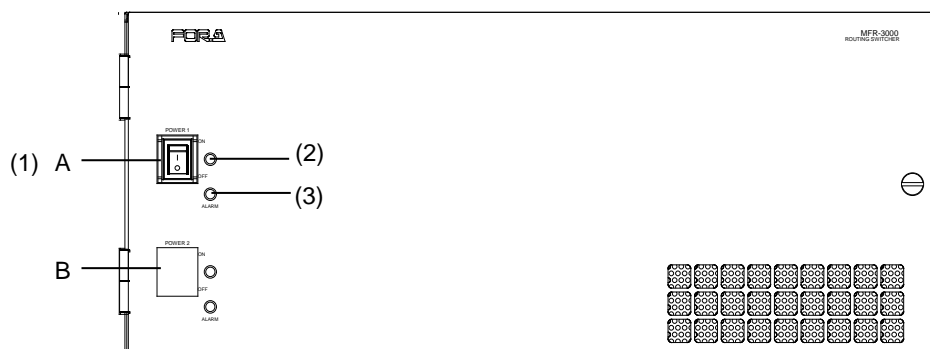

No.	Name	Description
A	POWER1	Power switch 1 (standard equipment) (1) Switch to turn unit power On/Off. (2) DC power supply voltage indication LED (Normal: lit green / Error: unlit) (3) Alarm indication LED (Normal: unlit / Power or fan error: lit, Secondary CPU active: flashing)
B	POWER2 ^(*)	Power switch 2 (optional equipment) (1) (2) and (3) the same as POWER1.

(*) The LED lights up if a power/fan error and CPU changeover occur simultaneously.

2-1-1. Matrix Size Chart

◆ Standard SDI Signal Routing

Matrix size varies depending on the number of installed MFR-8SDI and MFR-8SDO cards as shown below. (64 x 64 to 8 x 8)

		Number of cards: MFR-8SDO							
		8	7	6	5	4	3	2	1
Number of cards: MFR-8SDI	8	64 x 64	64 x 56	64 x 48	64 x 40	64 x 32	64 x 24	64 x 16	64 x 8
	7	56 x 64	56 x 56	56 x 48	56 x 40	56 x 32	56 x 24	56 x 16	56 x 8
	6	48 x 64	48 x 56	48 x 48	48 x 40	48 x 32	48 x 24	48 x 16	48 x 8
	5	40 x 64	40 x 56	40 x 48	40 x 40	40 x 32	40 x 24	40 x 16	40 x 8
	4	32 x 64	32 x 56	32 x 48	32 x 40	32 x 32	32 x 24	32 x 16	32 x 8
	3	24 x 64	24 x 56	24 x 48	24 x 40	24 x 32	24 x 24	24 x 16	24 x 8
	2	16 x 64	16 x 56	16 x 48	16 x 40	16 x 32	16 x 24	16 x 16	16 x 8
	1	8 x 64	8 x 56	8 x 48	8 x 40	8 x 32	8 x 24	8 x 16	8 x 8

A single MFR-16MV card provides 16 outputs (using two slots) and supports two multiview channels.

◆ **12-SDI Signal Routing**

12G-SDI signal routing is enabled by installing MFR-8SDIGB and MFR-8SDOGB cards and using them for 12G-SDI input/output. (If using MFR-8SDIGB and MFR-8SDOGB them for 3G-SDI input/output, the “Standard SDI Signal Routing” table in the previous page applies.) Matrix size varies depending on the number of installed MFR-8SDIGB and MFR-8SDOGB cards as shown below.

(16 x 16 to 2 x 2)

		Number of cards: MFR-8SDOGB (12G-SDI output)							
		8	7	6	5	4	3	2	1
Number of cards: MFR-8SDIGB (12G-SDI input)	8	16 x 16	16 x 14	16 x 12	16 x 10	16 x 8	16 x 6	16 x 4	16 x 2
	7	14 x 16	14 x 14	14 x 12	14 x 10	14 x 8	14 x 6	14 x 4	14 x 2
	6	12 x 16	12 x 14	12 x 12	12 x 10	12 x 8	12 x 6	12 x 4	12 x 2
	5	10 x 16	10 x 14	10 x 12	10 x 10	10 x 8	10 x 6	10 x 4	10 x 2
	4	8 x 16	8 x 14	8 x 12	8 x 10	8 x 8	8 x 6	8 x 4	8 x 2
	3	6 x 16	6 x 14	6 x 12	6 x 10	6 x 8	6 x 6	6 x 4	6 x 2
	2	4 x 16	4 x 14	4 x 12	4 x 10	4 x 8	4 x 6	4 x 4	4 x 2
	1	2 x 16	2 x 14	2 x 12	2 x 10	2 x 8	2 x 6	2 x 4	2 x 2

◆ **AUDIO Signal Routing**

Matrix size varies depending on the number of installed MFR-8AAI, MFR-8AAO, MFR-8AESI and MFR-8AESO cards as shown below. (1 stereo pair = 2 channels)

		MFR-8AAO or MFR-8AESO (number of cards)							
		8	7	6	5	4	3	2	1
MFR-8AAI or MFR-8AESI (number of cards)	8	64 x 64	64 x 56	64 x 48	64 x 40	64 x 32	64 x 24	64 x 16	64 x 8
	7	56 x 64	56 x 56	56 x 48	56 x 40	56 x 32	56 x 24	56 x 16	56 x 8
	6	48 x 64	48 x 56	48 x 48	48 x 40	48 x 32	48 x 24	48 x 16	48 x 8
	5	40 x 64	40 x 56	40 x 48	40 x 40	40 x 32	40 x 24	40 x 16	40 x 8
	4	32 x 64	32 x 56	32 x 48	32 x 40	32 x 32	32 x 24	32 x 16	32 x 8
	3	24 x 64	24 x 56	24 x 48	24 x 40	24 x 32	24 x 24	24 x 16	24 x 8
	2	16 x 64	16 x 56	16 x 48	16 x 40	16 x 32	16 x 24	16 x 16	16 x 8
	1	8 x 64	8 x 56	8 x 48	8 x 40	8 x 32	8 x 24	8 x 16	8 x 8

2-2. MFR-30FP Front Panel

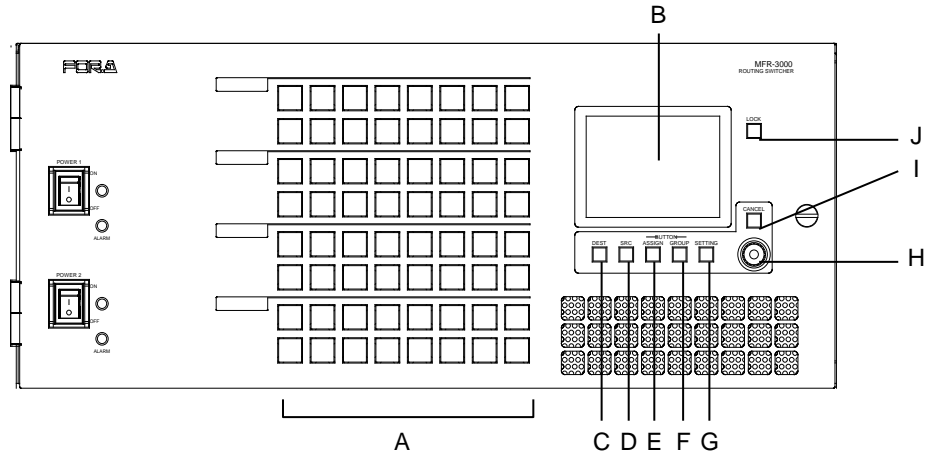

No.	Name	Description
A	Buttons	User assignable buttons. (LED: 1 color, green)
B	MENU	Displays setting menus and status.
C	DEST	Shows destination assignments on the display.
D	SRC	Shows source assignments on the display.
E	BUTTON ASSIGN	Opens the Button Assign screen.
F	BUTTON GROUP	Opens the Button Group screen.
G	SETTING	Opens the Setting screen.
H	CONTROL	Used to enter menu settings.
I	CANCEL	Used to cancel menu settings.
J	LOCK	Lock function assignable button

◆ Changing Button Labels

Button labels can be changed on user-assignable buttons. Utilize button label templates in the FOR-A web site. To remove button caps, use an optional tool.

To download button label templates, go to the **MFR-RU Series** page in the FOR-A site and open the **Documents** tab.

URL: http://www.for-a.com/products/mfr_ru_series/professional_router_p.html

2-3. MFR-3000 Rear Panel

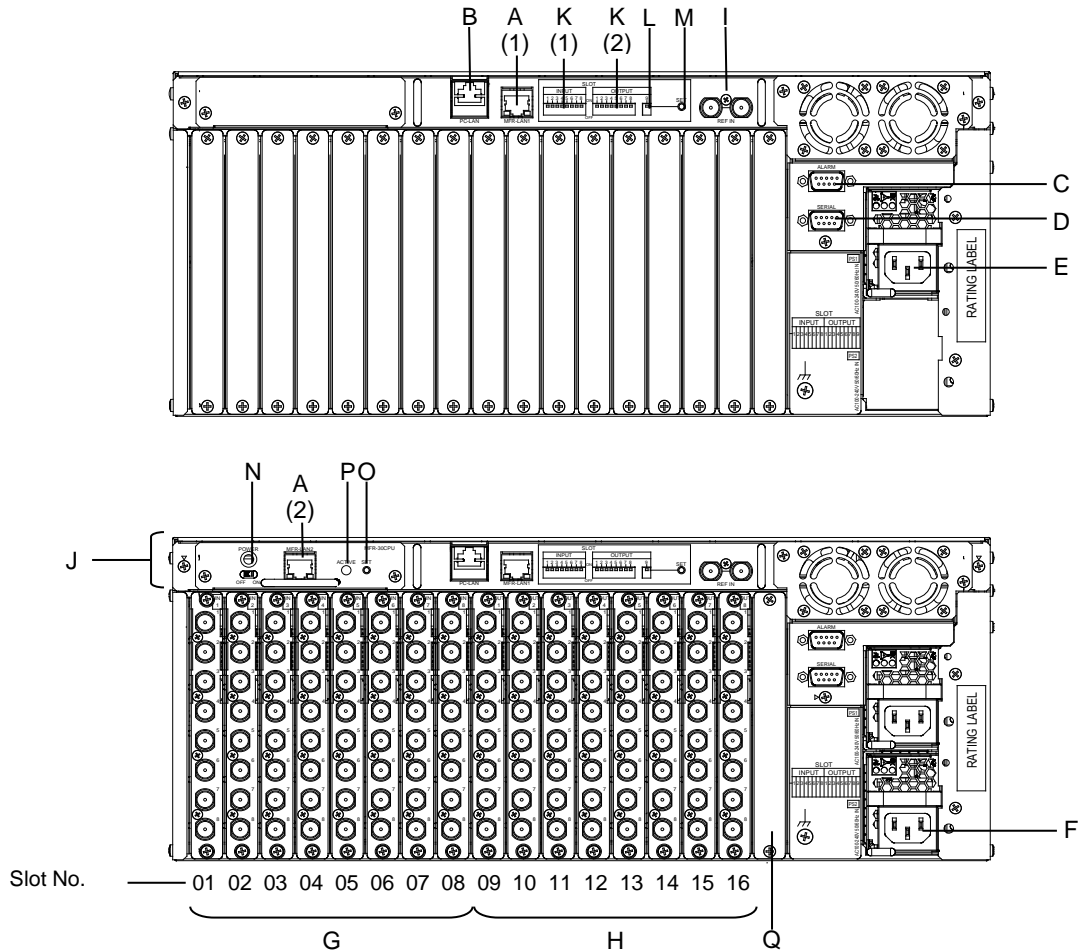

* The above figure shows an MFR-3000 with MFR-8SDI and MFR-8SDO cards installed.

No.	Name	Description
A	MFR-LAN	Ethernet ports for connection to MFR Remote Control Units and MFR-GPI (10/100/1000BASE-T, RJ-45) (1) For MFR-3000 (2) For MFR-30CPU
B	PC-LAN	Ethernet ports for connection to PC or other external unit (10/100BASE-TX RJ-45)
C	ALARM	Used for alarm output ▶ See Sec. 2-3-1. "Interfaces."
D	SERIAL	Used for control via a serial interface. RS-232C or RS-422 selectable. ▶ See Sec. 2-3-1. "Interfaces." The SERIAL connector is set to RS-422 as factory default. Consult your FOR-A reseller if you wish to change the setting.
E	AC IN1	Used to connect Power Supply Unit 1 (standard equipment) to an AC power source
F	AC IN2	Used to connect Power Supply Unit 2 (optional) to an AC power source
G	INPUT	Used for installing input cards
H	OUTPUT	Used for installing output cards
I	REF IN	Used to input a reference signal (BB or Tri-level sync) (with loop-through. Terminate with 75Ω terminator, if unused.)
J	MFR-30CPU	CPU option card
K	I/O card power switches	(1) Input card power switches (2) Output card power switches
L	NC	Not used

M	SET	Used to insert / remove input / output cards with MFR-3000 powered on.
N	CPU card power switch	Used to replace an MFR-30CPU card.
O	SET	Used to manually activate an installed MFR-30CPU.
P	ACTIVE	Displays the MFR-30CPU status. Lit: MFR-30CPU is active. Unlit: MFR-3000 CPU is active. Flashing: MFR-30CPU manual activation is disabled.
Q	OUTPUT9	Reserved slot

IMPORTANT

After installing an MFR-30CPU, MFR-LAN 1, MFR-LAN 2 and PC-LAN connectors must be connected to their respective devices to enable CPU redundancy. MFR-LAN and PC-LAN must be located on different LAN segments. Do not connect them to existing LAN networks.

◆ **Input /output cards and Slots**

No.	Slot	Video card	Audio card
G	INPUT1-8 (No. 01-08)	8SDI / 8SDIGB: Max. 8 cards	8AAI, 8AESI: Max 8 cards
H	OUTPUT1-8 (No. 09-16)	8SDO / 8SDOGB: Max. 8 cards 16MV: Max. 4cards *	8AAO, 8AESO: Max. 8 cards

* Available slot pairs are No. **09-10, 11-12, 13-14, and 15-16.**

◆ **Cooling fans**

Four cooling fans are installed in MFR-3000 units: FAN 1 and 2 are on the rear panel and FAN 3 and 4 are on the front panel as shown below.

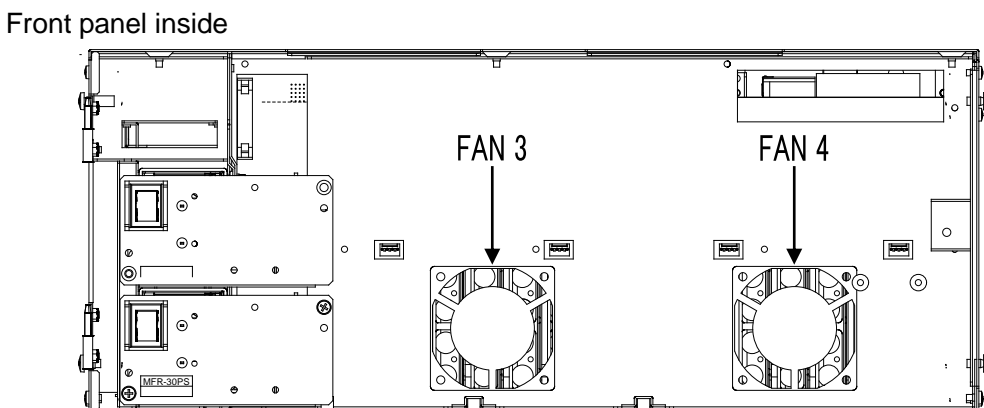
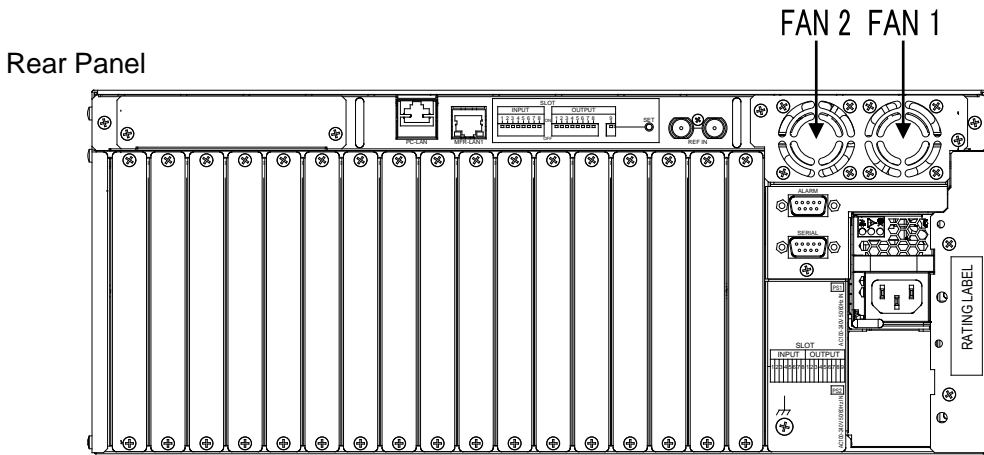

2-3-1. Interfaces

◆ SERIAL Connector (9-pin D-sub, male)

RS-232C or 422 interface can be selected via the CPU card DIP switches.
(See Sec. 2-3-4. "Changing the Interface from RS-422 to RS-232C.")

9-pin D-sub, male

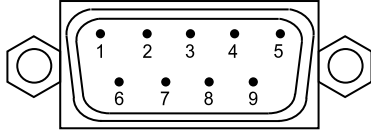

RS-422 connector pin assignment (9-pin, D-sub male)

Pin No.	Signal Name	Description
1	FG	Frame Ground
2	T-	Transmit data (-)
3	R+	Receive data (+)
4	SG	Signal Ground
5	NC	Unused
6	SG	Signal Ground
7	T+	Transmit data (+)
8	R-	Receive data (-)
9	FG	Frame Ground

* The maximum cable length is 100 m.

RS-232C Connector Pin Assignments (Factory default settings)

Pin No.	Signal Name	Description
1	NC	Not used
2	RxD	Received Data
3	TxD	Transmitted Data
4	DTR	Data Terminal Ready
5	SG	Signal Ground
6	DSR	Data Set Ready
7	RTS	Request To Send
8	CTS	Clear To Send
9	NC	Not used

* The maximum cable length is 10 m.

* DTR/DSR and RTS/CTS are internally connected respectively.

◆ **ALARM Connector (9-pin D-sub, female)**

Alarm 1 Out:

Under normal operation:	Pins 1 and 6 are open.
In a malfunction or power-off state:	Pins 1 and 6 are closed.

Alarm 2 Out:

Under normal operation:	Pins 2 and 7 are open.
In a malfunction or power-off state:	Pins 2 and 7 are closed.

Reset:

To reset the unit externally, short Pin 5 and a signal ground pin (8 or 9).

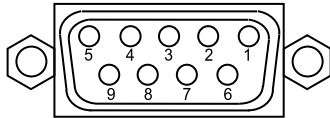

9-pin D-sub, female

ALARM Connector Pin Assignments

Pin No.	Signal Name	Description
1	ALARM 1 OUT	Alarm 1 output (Default setting: Fan)
2	ALARM 2 OUT	Alarm 2 output (Default setting: Power)
3	NC	Unused
4	NC	Unused
5	RESET IN	Reset in, active low
6	ALARM 1 COMMON	Alarm 1 output, common
7	ALARM 2 COMMON	Alarm 2 output, common
8	GND	Signal ground
9	GND	Signal ground

The following items can be set for ALARM1 OUT and ALARM2 OUT. The alarms can be assigned in the Web-Based Control.

Available alarm signals

Fan (including power unit cooling fans)
Power
Secondary CPU error
CPU Changeover (issued when the secondary CPU is activated to change over the operation)
Crosspoint Error

2-3-2. SDI Input/Output Cards

MFR-3000 units allow Input/Output cards to be installed into slots on the rear panel.

◆ Removing input /output cards

- (1) To remove an installed card while the MFR-3000 power is on, turn OFF the corresponding I/O card power switch (set the switch to down). *
- (2) Press **SET** for a second, then remove the card.

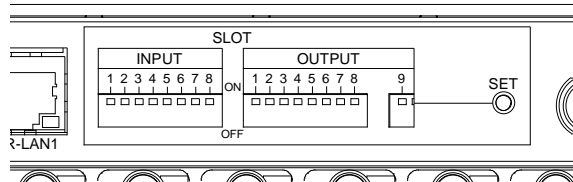

◆ Installing input /output cards

- (1) To install a card while the MFR-3000 power is on, MFR-3000, verify that the corresponding I/O card power switch is turned OFF (the switch is down). *
- (2) Press **SET** for a second, then insert the card.
- (3) Turn ON the I/O card power switch (set the switch up). *
- (4) Press **SET** for a second.

* To power off an installed MFR-16MV card using I/O card power switches, two power switches (for two slots) must be turned off.
Card power shutdown can be performed in the **Slot Status** page on the Web-based Control.

2-3-3. CPU Card Installation and Removal

CPU cards can be installed or removed with the MFR-3000 power turned on as shown below.

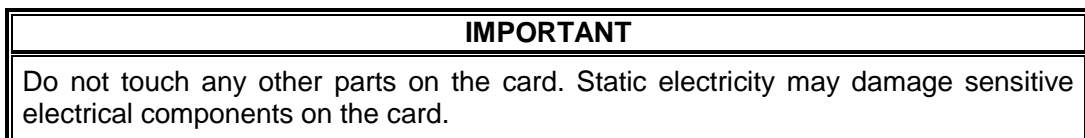

◆ Removing an installed MFR-30CPU card

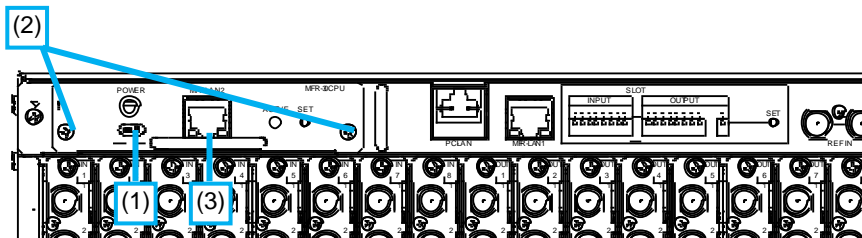

- (1) Turn OFF the power switch on the MFR-30CPU rear panel.
- (2) Release the screws on the both sides of the MFR-30CPU rear panel.
- (3) Grasp the handle and the card gently straight out of the slot.

◆ **Inserting an MFR-30CPU card**

- (1) Verify that the power switch on the card rear panel is turned OFF.
- (2) Align both edges of the MFR-30CPU with the guide rails in the slot and insert the card.
- (3) Verify that the MFR-30CPU is inserted properly, and secure both screws on the rear of the MFR-30CPU.
- (4) Connect MFR-LAN2 to the same network as MFR-LAN1.
- (5) If the power of the MFR-3000 is turned off, turn on the power and wait more than one minute.
- (6) Turn on the Power switch on the rear of the MFR-30CPU and wait about 5 minutes.

◆ **Manually activating the MFR-30CPU**

Once an MFR-30CPU is installed, it is NOT automatically activated. Follow the procedure below to manually activate the MFR-30CPU.

- (1) After installing an MFR-30CPU, press the **SET** button on the rear of the MFR-30CPU
- (2) Verify that the ACTIVE lamp is lit green. If the ACTIVE lamp flashes green, wait until it stops flashing and press the SET button again.

2-3-4. Changing the Interface from RS-422 to RS-232C

IMPORTANT

Note that internal switch settings should only be performed by qualified technical personnel.

(1) Remove the 6 screws on the MFR-3000 front panel to remove the panel.

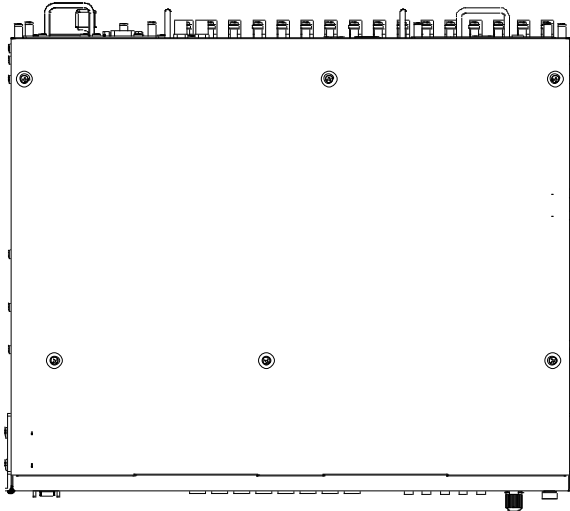

(2) The MAIN card factory default settings are as shown below.

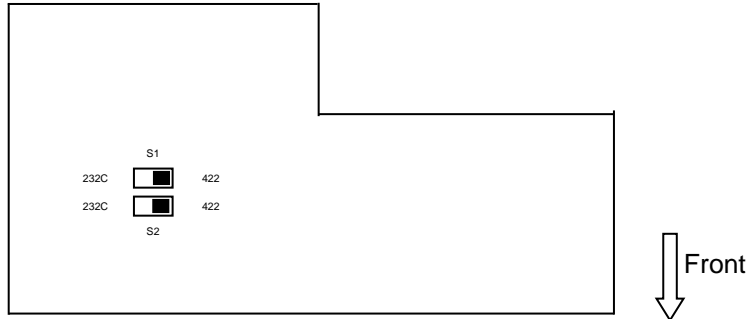

◆ Switch settings

Switch	Settings		
S1, S2	Used to select RS-232C or RS-422. Make your selection referring to the right figures. Both switches must be set the same.	Switch settings	RS-232C <input type="checkbox"/>
			RS-422 (Factory default) <input checked="" type="checkbox"/>

IMPORTANT

Do not change other switches

2-4. SDI Input / Output Cards

2-4-1. MFR-8SDI

MFR-8SDI is an SDI input card and can accept 8 of 3G/HD/SD-SDI and ASI signals. Up to **8** cards can be installed into **Slot No. 01 to 08**.

▶ See Sec. 2-1-1. "Matrix Size Chart."

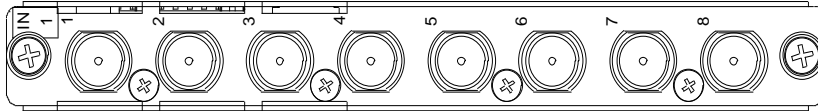

BNC x 8 inputs (3G/HD/SD-SDI or ASI signal auto-detection)

Set up input signals in the Web-based Control Software as shown below.

◆ Source Name

In the left side of the Web-based Control screen, click to select [**Router System Settings**] - [**Source Name**] in the menu tree to display the setting page.

This page allows you to change source names displayed on Remote Controllers or other devices.

◆ Source Assignment

Open the [Web-based Control: **Router System Settings - Source Assignment** page].

This page allows you to assign physical inputs to logical input channels.

2-4-2. MFR-8SDO

MFR-8SDO is an SDI output card and can output 8 of 3G/HD/SD-SDI and ASI signals. Up to **8** cards can be installed into **Slot No. 09 to 16**.

▶ See Sec. 2-1-1. "Matrix Size Chart."

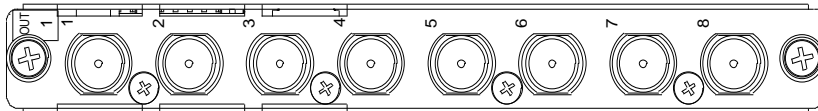

BNC x 8 outputs (3G/HD/SD-SDI or ASI signal depending on crosspoint selections)

Set up output signals in the Web-based Control Software as shown below.

◆ Destination Assignment

Open the [Web-based Control: **Router System Settings - Destination Assignment** page].

This page allows you to assign physical outputs to logical output channels.

◆ Destination Name

Open the [Web-based Control: **Router System Settings - Destination Name** page].

This page allows you to change destination names displayed on Remote Controllers.

2-4-3. MFR-16MV

MFR-16MV is an SDI output card and can output 16 of 3G/HD/SD-SDI and ASI signals. Up to **4** cards can be installed into **Slot No. 09 to 16**. Two slots are required for each card. Any two outputs (BNC) on the card are available for multiview channels.

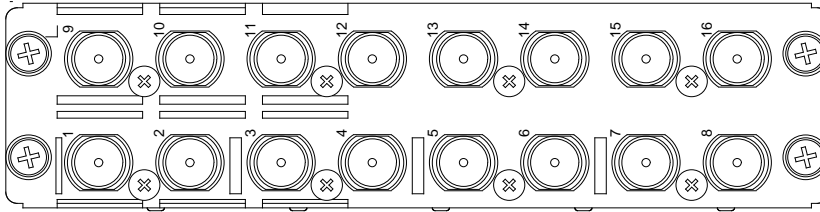

BNC x 16 outputs (3G/HD/SD-SDI or ASI signal depending on crosspoint selections)

Set up output signals in the Web-based Control Software as shown below.

◆ Destination Assignment

Open the [Web-based Control: **Router System Settings - Destination Assignment** page]. This page allows you to assign physical outputs to logical output channels.

◆ Destination Name

Open the [Web-based Control: **Router System Settings - Destination Name** page]. This page allows you to change destination names displayed on Remote Controllers.

2-4-4. MFR-8SDIGB

The MFR-8SDIGB is an SDI input card that accepts 12G- and 3G-SDI signals and supports Gearbox feature in which video signal conversions between 12G-SDI and Quad Link 3G-SDI, and between 2SI and SQD are available.

▶ See Sec. 8. "Gearbox Feature (MFR-8SDIGB/8SDOGB)."

The following input combinations are available (Only 1D and 2D BNC connectors can accept 12G-SDI signals):

- 12G-SDI signal: 2
- 3G-SDI signal: 8
- 12G-SDI signal: 1 and 3G-SDI signal: 4

Up to **8** cards can be installed into **Slot No. 01 to 08**.

▶ See Sec. 2-1-1. "Matrix Size Chart."

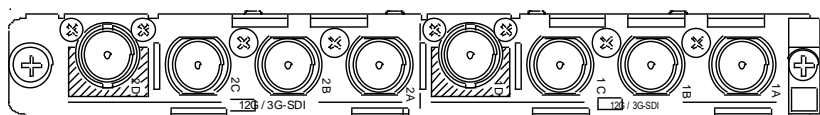

BNC x 8 inputs (12G/3G-SDI)

Set up input signals in the Web-based Control Software as shown below.

◆ Gearbox settings

In the left side of the Web-based Control screen, click to select [(**Main Unit Settings**) - **Gearbox Settings**] in the menu tree to display the settings page.

This page allows you to set Gearbox input and output signals, lock mode and delay.

◆ Source Assignment

In the left side of the Web-based Control screen, click to select [**Router System Settings** - **Source Assignment**] in the menu tree to display the settings page..

This page allows you to assign physical inputs to logical input channels.

◆ Source Name

In the left side of the Web-based Control screen, click to select [**Router System Settings**] - [**Source Name**] in the menu tree to display the settings page.

This page allows you to change source names displayed on Remote Controllers or other devices.

2-4-5. MFR-8SDOGB

The MFR-8SDOGB is an SDI output card that accepts 12G- and 3G-SDI signals and supports Gearbox feature in which video signal conversions between 12G-SDI and Quad Link 3G-SDI, and between 2SI and SQD are available.

▶ See Sec. 8. "Gearbox Feature (MFR-8SDIGB/8SDOGB)."

The following output combinations are available:

- 12G-SDI signal: 2
- 3G-SDI signal: 8
- 12G-SDI signal: 1 and 3G-SDI signal: 4

Up to **8** cards can be installed into **Slot No. 09 to 16**.

▶ See Sec. 2-1-1. "Matrix Size Chart."

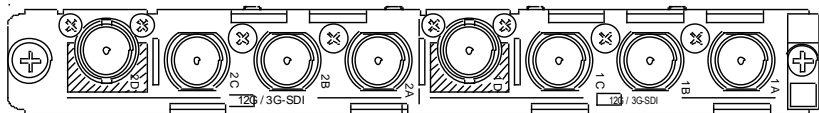

BNC x 8 outputs (12G/3G-SDI)

Set up output signals in the Web-based Control Software as shown below.

◆ Gearbox settings

In the left side of the Web-based Control screen, click to select [(**Main Unit Settings**) - (**Gearbox Settings**)] in the menu tree to display the settings page.

This page allows you to set Gearbox input and output signals, lock mode and delay.

◆ Destination Assignment

Open the [Web-based Control: **Router System Settings - Destination Assignment** page].

This page allows you to assign physical outputs to logical output channels.

◆ Destination Name

Open the [Web-based Control: **Router System Settings - Destination Name** page].

This page allows you to change destination names displayed on Remote Controllers.

2-5. Audio Input / Output Cards

Source and destination assignment procedures for audio signals are the same as those for SDI signals. Refer to the previous chapter. This chapter describes audio specific setup. Audio signals should be setup in the Web-based Control pages

- ▶ See [Web-based Control: **Audio Settings** page].

2-5-1. MFR-8AAI (Analog Input)

MFR-8AAI is an analog audio input card with A/D converter.

Up to **8** cards can be installed into **Slot No. 01 to 08**.

- ▶ See section 2-1-1. "Matrix Size Chart."

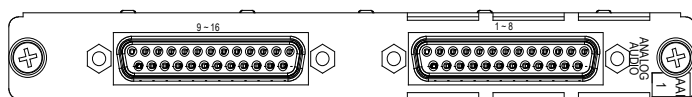

25-pin D-Sub (female) x 2 (8 stereo pairs, 16 channels), 600 Ohm or high impedance

◆ Analog Audio Input

Select the input impedance and adjust the input level per each stereo pair (2 channels) in the [Web-based Control: **Audio Settings** page].

Analog Input Terminal	Select 600 ohm or High impedance for analog input.
Analog Input Level	Adjust analog input level.

◆ Analog Audio Connection

For balanced audio signals, connect the **hot**, **cold** and **shield** conductor to "+", "-", and "**COM**" pins respectively.

For unbalanced audio signals, connect the conductor that carries **audio** to a "+" pin and **ground** to "**COM**."

Analog Audio Connector (25-pin D-sub, female, inch screws) x 2

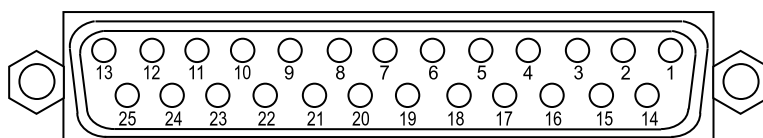

Connector Pin Assignments

Channels 1 to 8

Pin No.	Setting	Pin No.	Setting
13	CH1+	25	CH1 COM
12	CH1-	24	CH2+
11	CH2 COM	23	CH2-
10	CH3+	22	CH3 COM
9	CH3-	21	CH4+
8	CH4 COM	20	CH4-
7	CH5+	19	CH5 COM
6	CH5-	18	CH6+
5	CH6 COM	17	CH6-
4	CH7+	16	CH7 COM
3	CH7-	15	CH8+
2	CH8 COM	14	CH8-
1	SG	-	-

Channels 9 to 16

Pin No.	Setting	Pin No.	Setting
13	CH9+	25	CH9 COM
12	CH9-	24	CH10+
11	CH10 COM	23	CH10-
10	CH11+	22	CH11 COM
9	CH11-	21	CH12+
8	CH12 COM	20	CH12-
7	CH13+	19	CH13 COM
6	CH13-	18	CH14+
5	CH14 COM	17	CH14-
4	CH15+	16	CH15 COM
3	CH15-	15	CH16+
2	CH16 COM	14	CH16-
1	SG	-	-

2-5-2. MFR-8AAO (Analog Output)

MFR-8AAO is an analog audio output card with D/A converter. Up to **8** cards can be installed into **Slot No. 09 to 16**.

▶ See section 2-1-1. "Matrix Size Chart."

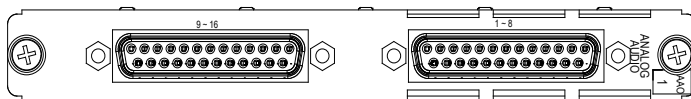

◆ MUTE

Mute can be enabled or disabled for each channel.

Mute should be set in the [Web-based Control: **Audio Settings** page].

◆ Digital-to-Analog Conversion

16 channels (8 stereo pairs) can be converted and output as analog audio. Audio level and gain can be set for each stereo pair.

Audio level and gain should be set in the [Web-based Control: **Audio Settings** page].

Level	Sets analog signal output level for each channel. Audio output level is determined by the digital input level and this setting as shown in the table below. Maximum output level is +24dBm.
Gain	Adjusts signal gain for each channel.

Analog Output Level (determined by the input level and level setting)

Digital audio input level	Analog Output Level Setting			
	-10dBm	0dBm	4dBm	8dBm
-24dBFS	-14dBm	-4dBm	0dBm	+4dBm
-20dBFS	-10dBm	0dBm	+4dBm	+8dBm
-18dBFS	-8dBm	+2dBm	+6dBm	+10dBm
0dBFS	+10dBm	+20dBm	+24dBm	CLIP

◆ **Analog Audio Connection**

For balanced audio signals, connect the **hot**, **cold** and **shield** conductor to "+", "-", and "**COM**" pins respectively.

For unbalanced audio signals, connect the conductor that carries **audio** to a "+" pin and **ground** to "**COM**."

Analog Audio Connector (25-pin D-sub, female, inch screws) x 2

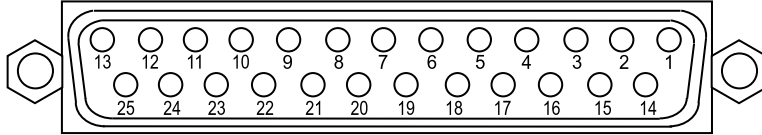

Pin Assignments

Channels 1 to 8

Pin No.	Setting	Pin No.	Setting
13	CH1+	25	CH1 COM
12	CH1-	24	CH2+
11	CH2 COM	23	CH2-
10	CH3+	22	CH3 COM
9	CH3-	21	CH4+
8	CH4 COM	20	CH4-
7	CH5+	19	CH5 COM
6	CH5-	18	CH6+
5	CH6 COM	17	CH6-
4	CH7+	16	CH7 COM
3	CH7-	15	CH8+
2	CH8 COM	14	CH8-
1	SG	-	-

Channels 9 to 16

Pin No.	Setting	Pin No.	Setting
13	CH9+	25	CH9 COM
12	CH9-	24	CH10+
11	CH10 COM	23	CH10-
10	CH11+	22	CH11 COM
9	CH11-	21	CH12+
8	CH12 COM	20	CH12-
7	CH13+	19	CH13 COM
6	CH13-	18	CH14+
5	CH14 COM	17	CH14-
4	CH15+	16	CH15 COM
3	CH15-	15	CH16+
2	CH16 COM	14	CH16-
1	SG	-	-

2-5-3. MFR-8AESI (AES Input).

MFR-8AESI is a digital audio input card.

Up to **8** cards can be installed into **Slot No. 01 to 08**.

► See section 2-1-1. "Matrix Size Chart."

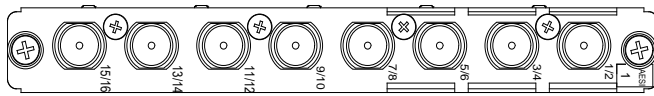

BNC x 8 inputs (8 stereo pairs, 16 channels), unbalanced, 75 Ohm

2-5-4. MFR-8AESO (AES Output)

MFR-8AESO is a digital audio output card.

Up to **8** cards can be installed into **Slot No. 09 to 16**.

► See section 2-1-1. "Matrix Size Chart."

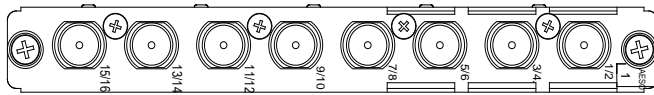

BNC x 8 outputs (8 stereo pairs, 16 channels), unbalanced, 75 Ohm

2-6. Remote Control Panel

2-6-1. Front Panel

◆ MFR-39RUA

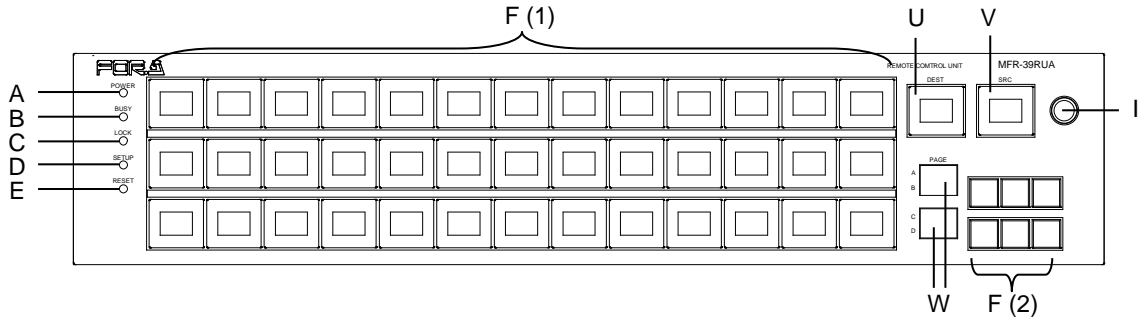

◆ MFR-39RU

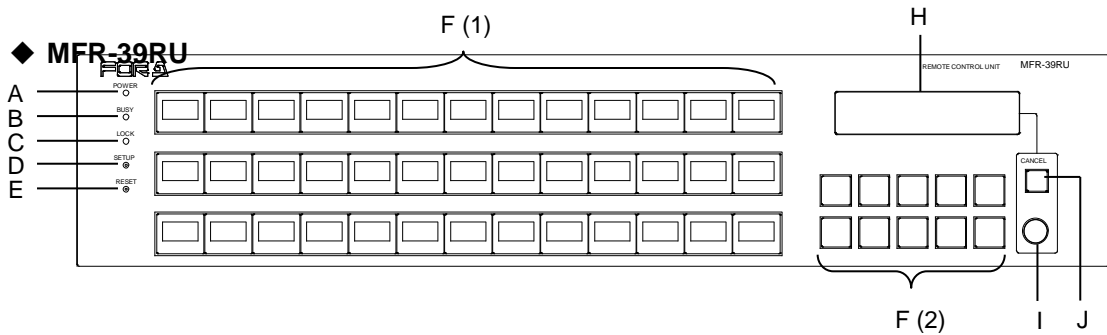

◆ MFR-40RU

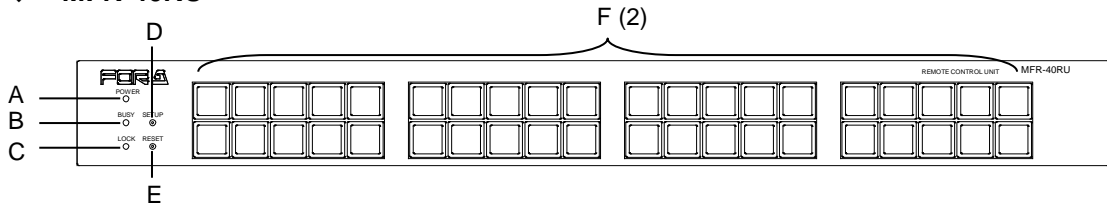

◆ MFR-18RU/18RUA

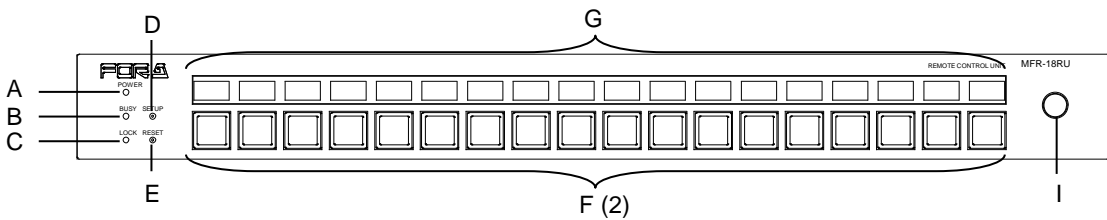

◆ MFR-16RU

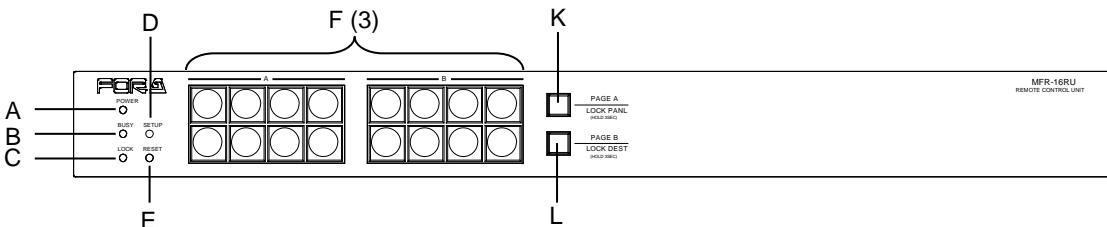

◆ **MFR-16RUD**

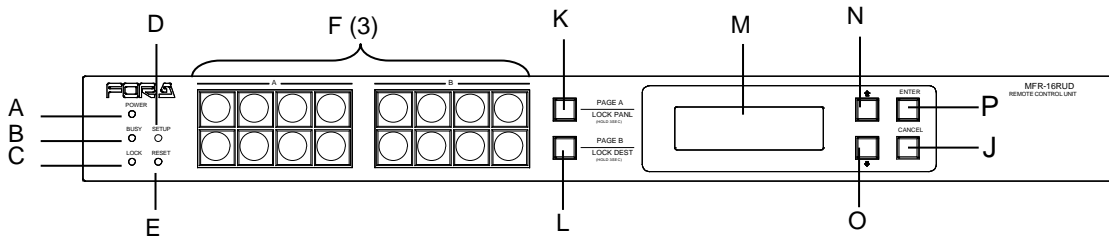

◆ **MFR-16RUW**

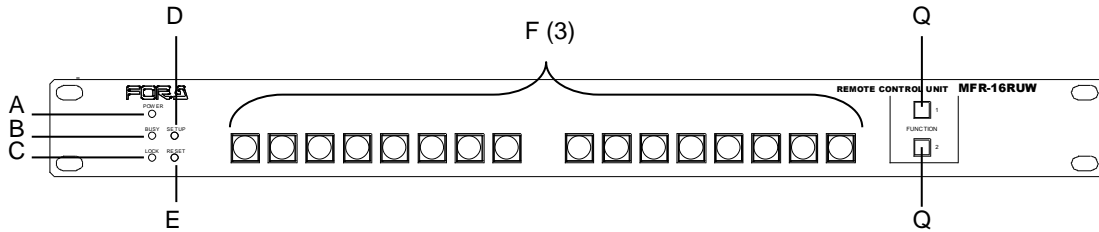

◆ **MFR-32RUW**

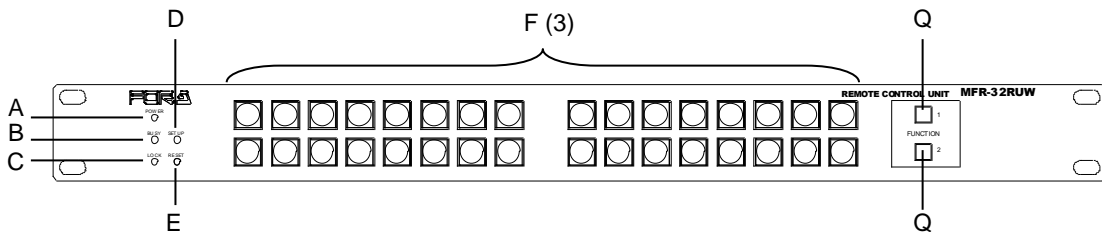

◆ **MFR-64RUW**

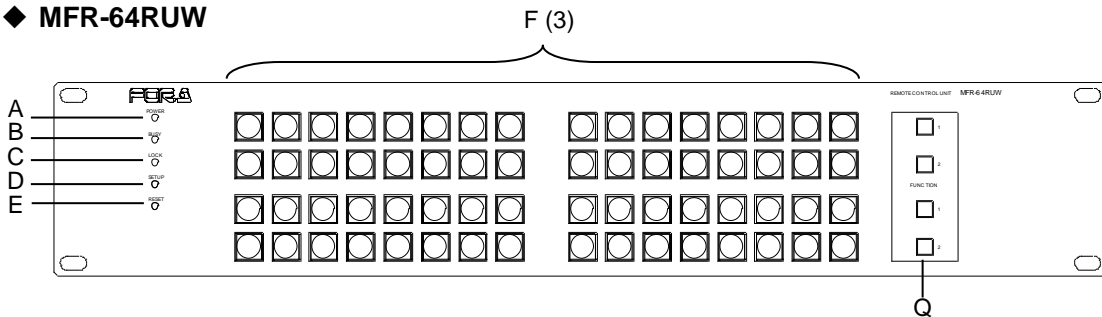

◆ **MFR-16RUTA**

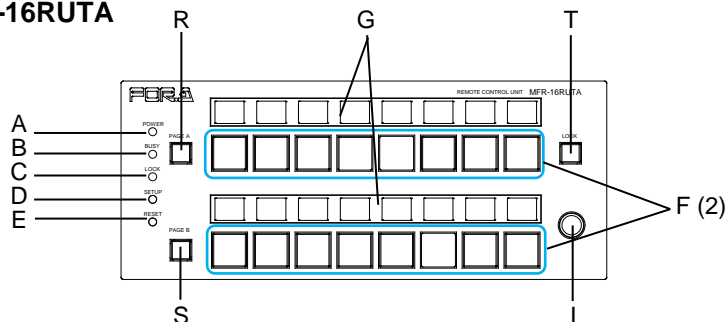

No.	Item	Description
A	POWER	Displays the power status. ▶ See the table on the next page for details on indications.
B	BUSY	Displays the flash memory writing status of backup settings. ▶ See the table on the next page for details on indications.

C	LOCK	Displays the LOCK status. ▶ See the table below for details on indications. ▶ See Sec. 6-3. "Lock" for details on the lock function.
D	SETUP	Used for IP address or other settings. ▶ See Sec. 5-6. "Setup Menu." for details on the SETUP menu.
E	RESET	Used to re-initialize the remote control panel.
F	Buttons	All buttons are user assignable. (1) 7-color selectable button name indication (red, green, yellow, blue, white, cyan or magenta) (hereafter called LCD) (2) 3-color selectable button illumination (red, green or orange) (3) Green illumination
G	NAME DISPLAY	7-color selectable button name/assignment indications (red, green, yellow, blue, white, cyan or magenta) (hereafter called LCD)
H	MENU	Displays setting menus and status.
I	CONTROL	Used to enter menu settings.
J	CANCEL	Used to cancel menu settings.
K	PAGE A / LOCK PANL	Page switch button. Pressing the button switches Page 1 and Page 2 of Group A. The button is unlit if Page 1 is applied. The button is lit orange if Page 2 is applied. To use the button as LOCK LOCAL, press and hold down (within 3 seconds). (*)
L	PAGE B / LOCK DEST	Page switch button. Pressing the button switches Page 1 and Page 2 of Group B. The button is unlit if Page 1 is applied. The button is lit orange if Page 2 is applied. To use the button as LOCK ALL, press and hold down (within 3 seconds). (*)
M	Display	Displays crosspoints and button assignments.
N	↑	UP / DOWN buttons, used to select items to be viewed on the Display.
O	↓	
P	ENTER	Used to confirm settings on the Display.
Q	FUNCTION	Function assignable buttons. (Green illumination)
R	PAGE A	If enabled, Group A pages can be controlled.
S	PAGE B	If enabled, Group B pages can be controlled.
T	LOCK	Lock function assignable button
U	Current DEST button	Displays the current destination channel.
V	Current SRC button	Displays the current source channel.
W	Current PAGE display	Displays the current page.

(*) PAGE Switch and LOCK features are initially enabled and can be disabled in the [Web-based Control: Assign Function page], respectively.

◆ Color indications on the MFR-RU front panel

LED color	Green	Red	Orange
POWER LED	Normal	Power alarm	
BUSY LED	Normal processing		Writing to flash memory
LOCK LED	Operation locked by Lock Local	Operation locked by Lock All, or locked by Lock Other from another unit.	Lock Other is activated in own unit.

* LOCK LED flashes if the locked operation is accessed. The operation will not perform.

* POWER LED lights red if the unit is turned on while it is not connected to a network.

* All indicators, POWER, BUSY and LOCK, light orange while the SETUP menu is displayed.

IMPORTANT

After finishing settings, do **not power OFF** the unit while BUSY LED is **lit orange**, since the system is writing to Flash. (It takes about two minutes at max.)

◆ **Changing Button Labels**

Button labels can be changed on user-assignable buttons. Utilize button label templates in the FOR-A web site. To remove button caps, use an optional tool.

To download button label templates, go to the **MFR-RU Series** page in the FOR-A site and open the **Documents** tab.

URL: http://www.for-a.com/products/mfr_ru_series/professional_router_p.html

2-6-2. Rear Panel

◆ MFR-39RU/39RUA



◆ MFR-40RU / MFR-18RU / MFR-18RUA

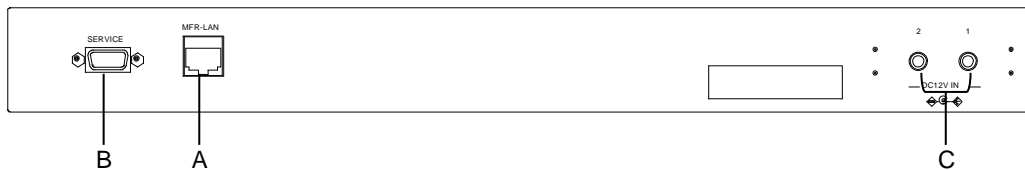

◆ MFR-16RU / MFR-16RUD

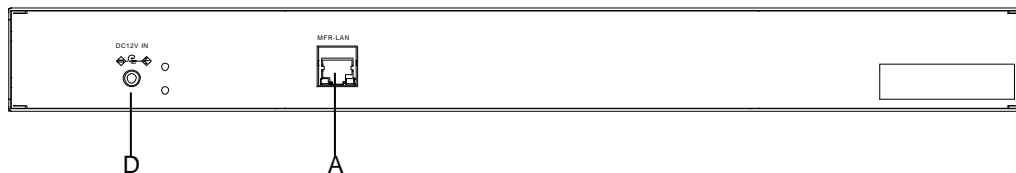

◆ MFR-16/32/64RUW

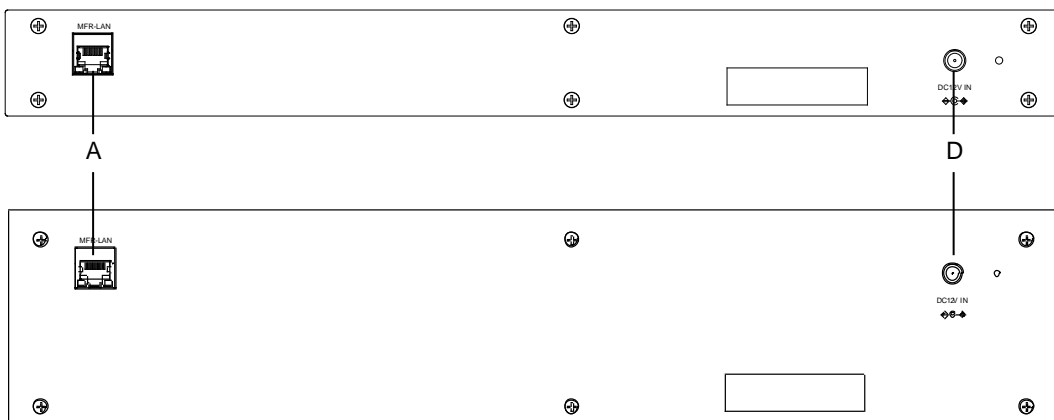

◆ MFR-16RUTA

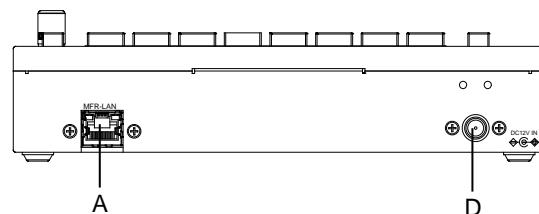

No.	Item	Description
A	MFR-LAN *1	Used to connect the MFR main unit Ethernet port (10/100BASE-TX)
B	SERVICE	Used for maintenance only. Do not use.
C	DC 12 V IN 1,2	Used to supply 12 V DC power.
D	DC 12 V IN	Used to supply 12 V DC power.

*1 The MFR-LAN connector may be labeled 10/100BASE-T on the previous model.

2-7. MFR-GPI

2-7-1. Front Panel

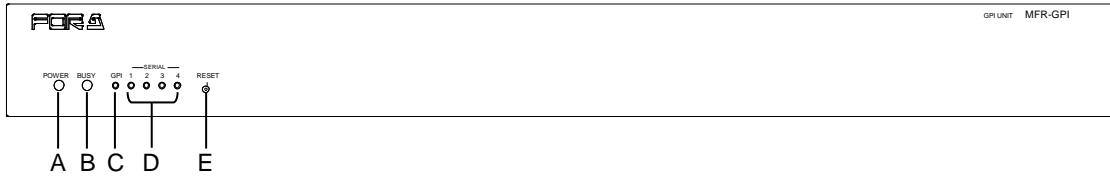

No.	Item	Description
A	POWER	Displays the power status. ▶ See the table below for details on indications.
B	BUSY	Displays the flash memory writing status of backup settings. ▶ See the table below for details on indications.
C	GPI	When the GPI function is assigned using the Web-based Control, the LED lights green. The LED remains unlit when there is no assignment.
D	SERIAL 1-4	When a serial port is assigned using the Web-based Control, the LED lights green. The LED remains unlit when there is no assignment.
E	RESET	Used to re-initialize the GPI unit.

◆ Color indications on the MFR-GUI front panel

LED \ LED Color	Green	Red	Orange
POWER	Normal	Power alarm	
BUSY	Normal processing		Writing to flash memory

* POWER LED lights red if the unit is turned on but is unconnected to a network.

IMPORTANT

After finishing settings, do **not power OFF** the unit while BUSY LED is **lit orange**, since the system is writing to Flash. (It takes about two minutes at max.)

2-7-2. Rear Panel

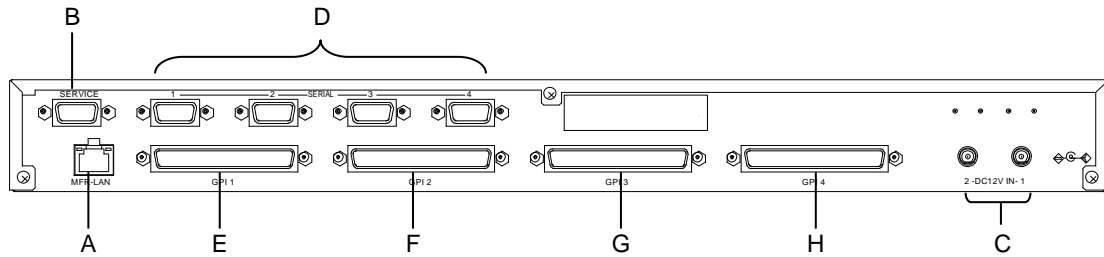

No.	Item	Description
A	MFR-LAN (*1)	Used to connect the MFR main unit Ethernet port (10/100BASE-TX)
B	SERVICE	Used for maintenance only. Do not use.
C	DC 12 V IN 1 and 2	Used to supply 12 V DC power.
D	SERIAL1 to 4	Used for serial interface control. The default setting is RS-422. RS-232C is also selectable using switches on the internal card. ▶ See Sec. 2-7-4. "Switches on the Card." Pin assignments are the same as those on the MFR main unit. ▶ See Sec. 2-3-1. "Interfaces."
E	GPI 1 (Port no: 1)	Used for GPI input / output connections. (32 total assignable inputs and outputs)
F	GPI 2 (Port no: 2)	Used for GPI input / output connections. (32 total assignable inputs and outputs)
G	GPI 3 (Port no: 3)	Used for GPI input / output connections. (32 total assignable inputs and outputs)
H	GPI 4 (Port no: 4)	Used for GPI input / output connections. (32 total assignable inputs and outputs)

(*1) The MFR-LAN connector may be labeled 10/100BASE-T on the previous model.

2-7-3. Interfaces (MFR-GPI)

◆ GPI IN / TALLY OUT Connector (37-pin D-sub, female)

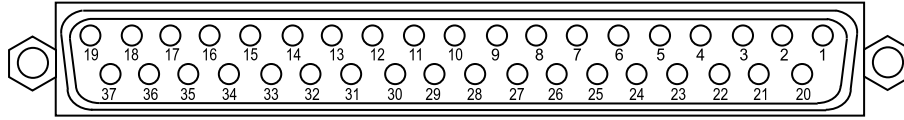

Pin No.	Signal	Pin No.	Signal
1	GPI_IN / TALLY_OUT 01 #	20	GPI_IN / TALLY_OUT 20 #
2	GPI_IN / TALLY_OUT 02 #	21	GPI_IN / TALLY_OUT 21 #
3	GPI_IN / TALLY_OUT 03 #	22	GPI_IN / TALLY_OUT 22 #
4	GPI_IN / TALLY_OUT 04 #	23	GPI_IN / TALLY_OUT 23 #
5	GPI_IN / TALLY_OUT 05 #	24	GPI_IN / TALLY_OUT 24 #
6	GPI_IN / TALLY_OUT 06 #	25	GPI_IN / TALLY_OUT 25 #
7	GPI_IN / TALLY_OUT 07 #	26	GPI_IN / TALLY_OUT 26 #
8	GPI_IN / TALLY_OUT 08 #	27	GPI_IN / TALLY_OUT 27 #
9	GPI_IN / TALLY_OUT 09 #	28	GPI_IN / TALLY_OUT 28 #
10	GPI_IN / TALLY_OUT 10 #	29	GPI_IN / TALLY_OUT 29 #
11	GPI_IN / TALLY_OUT 11 #	30	GPI_IN / TALLY_OUT 30 #
12	GPI_IN / TALLY_OUT 12 #	31	GPI_IN / TALLY_OUT 31 #
13	GPI_IN / TALLY_OUT 13 #	32	GPI_IN / TALLY_OUT 32 #
14	GPI_IN / TALLY_OUT 14 #	33	Frame ground
15	GPI_IN / TALLY_OUT 15 #	34	Frame ground
16	GPI_IN / TALLY_OUT 16 #	35	Frame ground
17	GPI_IN / TALLY_OUT 17 #	36	+4.8V output
18	GPI_IN / TALLY_OUT 18 #	37	+4.8V output
19	GPI_IN / TALLY_OUT 19 #		

* The symbol "#" at the end of signals represents the port number (1, 2, 3 or 4).

* The maximum total output current for all +4.8 V outputs is 1.5 A.

* The GPI input pulse width should be 54 ms or more.

◆ GPI IN Circuits

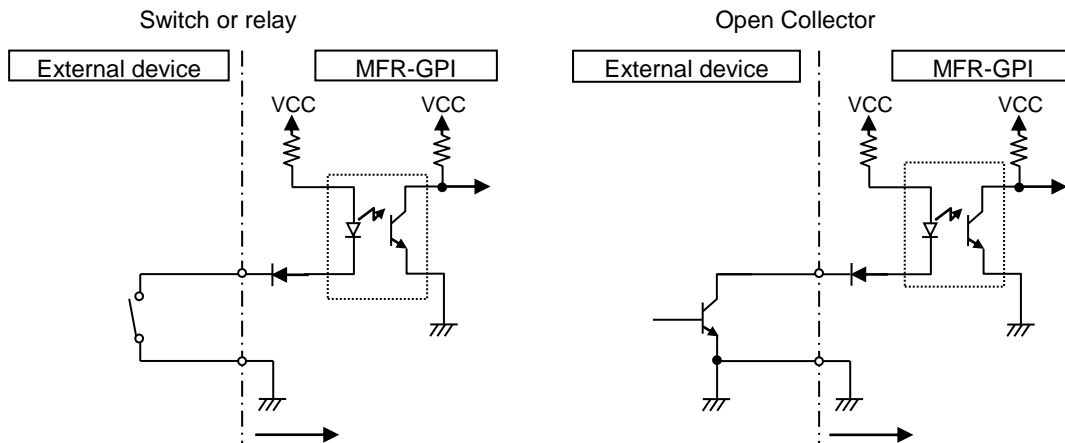

◆ GPI OUT / TALLY OUT Circuit

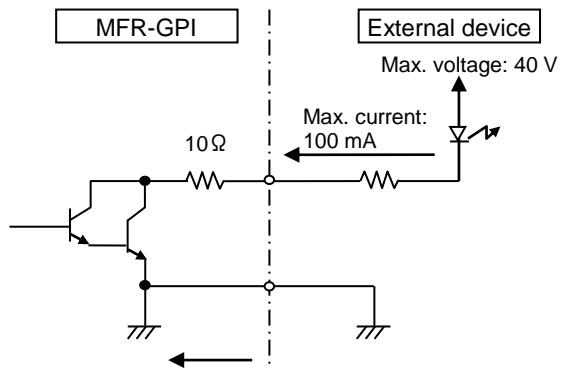

* The voltage is about 0.9 V when turned-on.

2-7-4. Switches on the Card

CAUTION
<p>Do not access internal cards or make connections with the unit powered ON. Always power OFF all connected units / disconnect power cords prior to accessing the interior.</p> <p>Further note that adjustments and maintenance should only be performed by qualified technical personnel familiar with FOR-A equipment.</p>

Remove the two screws on both sides of the MFR-GPI to access the internal card as shown below. The figure below shows the factory default switch settings.

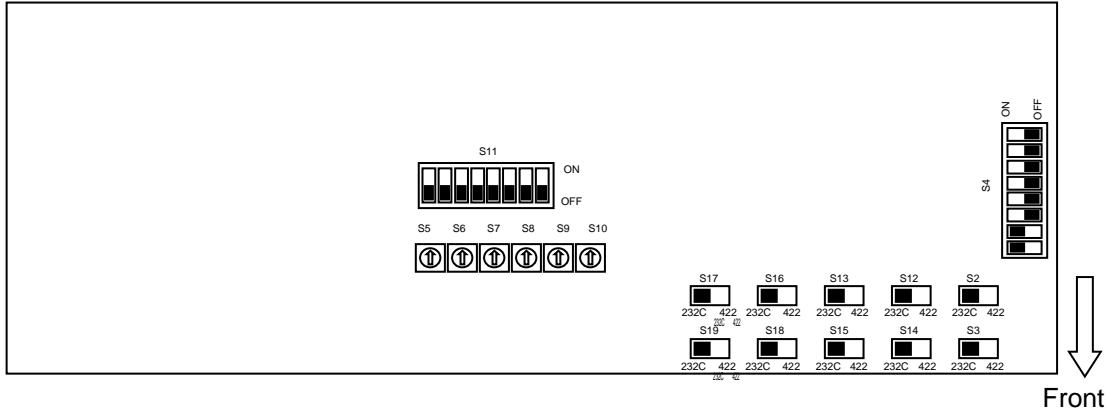

Switch	Function / Settings		
S2, S3	Used for maintenance. Do not use.		
S4	Used for maintenance. Do not use. (The factory default setting is as shown at right. The black boxes (■) represent switches.)		
S5, S6, S7, S8, S9, S10	Used for IP address setting.		
S11	Used for maintenance. Do not use.		
S12, S14	Used to select RS-232C/RS-422 for SERIAL 1. The default setting is RS-422 (both switches to the right). To change to RS-232C, set both switches to the left.	Switch Settings	RS-232C (Factory default setting)
S13, S15	Used to select RS-232C/RS-422 for SERIAL 2. The default setting is RS-422 (both switches to the right). To change to RS-232C, set both switches to the left.		
S16, S18	Used to select RS-232C/RS-422 for SERIAL 3. The default setting is RS-422 (both switches to the right). To change to RS-232C, set both switches to the left.		RS-422
S17, S19	Used to select RS-232C/RS-422 for SERIAL 4. The default setting is RS-422 (both switches to the right). To change to RS-232C, set both switches to the left.		

2-8. MFR-TALM

2-8-1. Front Panel

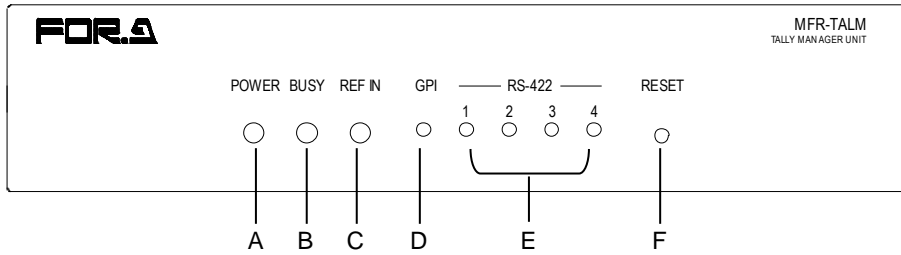

No.	Item	Description
A	POWER	Displays the power status. ▶ See the table below for details on indications.
B	BUSY	Displays the flash memory writing status of backup settings. ▶ See the table below for details on indications.
C	REF IN	Lights green when an external reference signal is present.
D	GPI	Lights green a GPI function is assigned. Turns off when no GPI function is assigned.
E	RS-422 1-4	Lights green when a port function is assigned. Turns off when no port function is assigned.
F	RESET	Resets MFR-TALM.

◆ Color indications on the MFR-TALM front panel

LED \ LED Color	Green	Red	Orange
POWER	Normal	Power alarm	
BUSY	Normal processing		Writing to flash memory

IMPORTANT

Do not power off the unit while BUSY LED is lit orange (writing to the flash memory, about 2 seconds at most).

2-8-2. Rear Panel

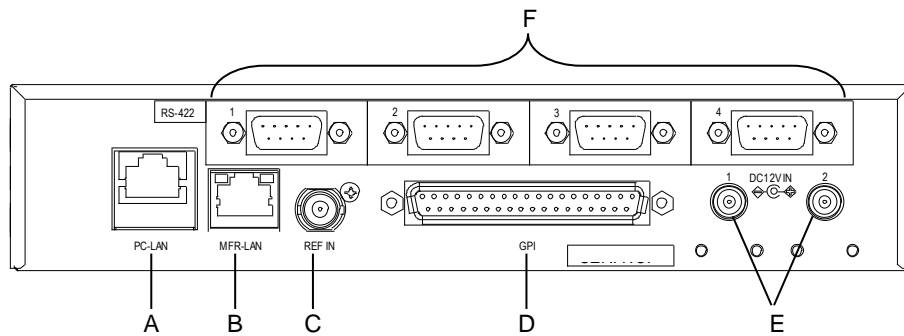

No.	Item	Description
A	PC-LAN	Ethernet port for connection to PC or other external unit (10/100BASE-TX, RJ-45)
B	MFR-LAN	Ethernet port for connection to MFR main unit (10/100/1000BASE-T, RJ-45)
C	REF IN	Used to input a reference signal (BB or Tri-level sync signal) (with loop-through. Terminate with 75Ω terminator, if unused.)
D	GPI	Used to input/output GPI signals for external control. (32 total assignable inputs and outputs) Pin assignments are the same as those of the MFR-GPI connectors. ▶ See Sec. 2-7-3. "Interfaces (MFR-GPI)."
E	DC 12 V IN 1,2	Used to supply 12 V DC power.
F	RS-422 1-4	Used for RS-422 interface control. Pin assignments are the same as those of the MFR main unit. ▶ See Sec. 2-3-1. "Interfaces."

3. System Configuration Example

3-1. Basic Configuration

The block diagram below shows an example of the basic MFR routing system that consists of an MFR-3000, Remote Unit and the Web-based Control accessed from a computer. Make sure to connect both MFR-LANs (CPU1) and (CPU2) to a LAN respectively for CPU redundancy. Their LAN connections must be separated from the network segment of PC-LAN and other devices. (Default IP addresses (Net mask: 255.255.255.0) are used in the configuration example below.)

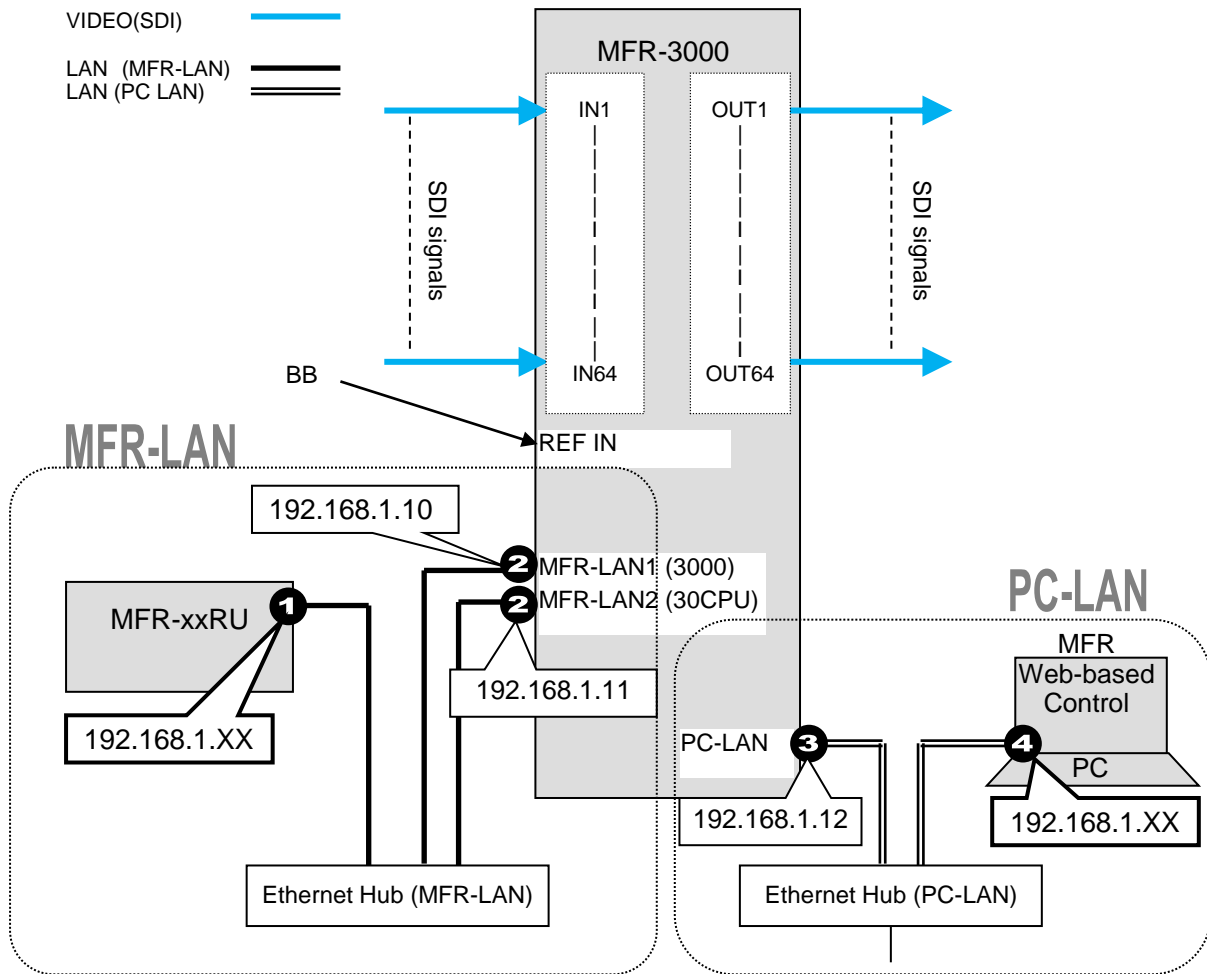

◆ LAN Port Settings

Port	RU Front Panel	Web-based Control	Sec. in Web Control Manual
①	MFR-39RUA: See sec. 5-4-4. MFR-39RU: See sec. 5-6-1. MFR-18RU/18RUA: See sec. 5-8-1 and 5-8-2. Other RUs: See sec. 5-9-1 and 5-9-2.	RU Settings page	6-2
②	---	MU Settings page	5-2
③	MFR-39RUA: See sec. 5-4-4(display only). MFR-39RU: See sec. 5-6-3(display only). MFR-18RU/18RUA: See sec. 5-8-1 (display only). Other RUs: See sec. 5-10-1 (display only).	Network Settings page	4-1-7

3-2. Main Unit Linking

The Main Unit Link feature allows you to control multiple MFR-3000 units at the same time. Two types of system configurations are available:

- Parallel Link:** Controls several MFR-3000 units at the same time.
- Expanded Matrix:** Creates an expanded virtual matrix by linking MFR-3000 units.

Note that each Expanded Matrix system requires specific BNC connections. **IP port and SNMP settings** should be performed on **each** MFR-3000 unit. After these settings are completed, all linked MFR-3000 units are set and **controlled** together on the unit that is specified as **Master**.

Main Unit Link Specifications	
●	Main Unit Link systems are set and controlled through a specified master unit. Up to 8 MFR-3000 units can be linked within a system.
●	Parallel links using each one of MFR-3000 and one MFR-8000 are possible. MFR-3000 and other MFR main units (MFR-3000/ 3232/ 3216/ 1616/ 1616R/ 1616A/ 3216RPS/ 3232RPS) cannot be linked to each other.
●	Only SDI signals can be routed in Expanded Matrix systems. However, MFR-3000 inputs and outputs not used in the Main Unit Link can be assigned independently and used as paralleled link matrix.
●	All MFR main units in a link system must be linked together and independent units cannot exist in the system.

3-2-1. Parallel Link System Example

The system example below is a redundant system using two MFR-3000 units.

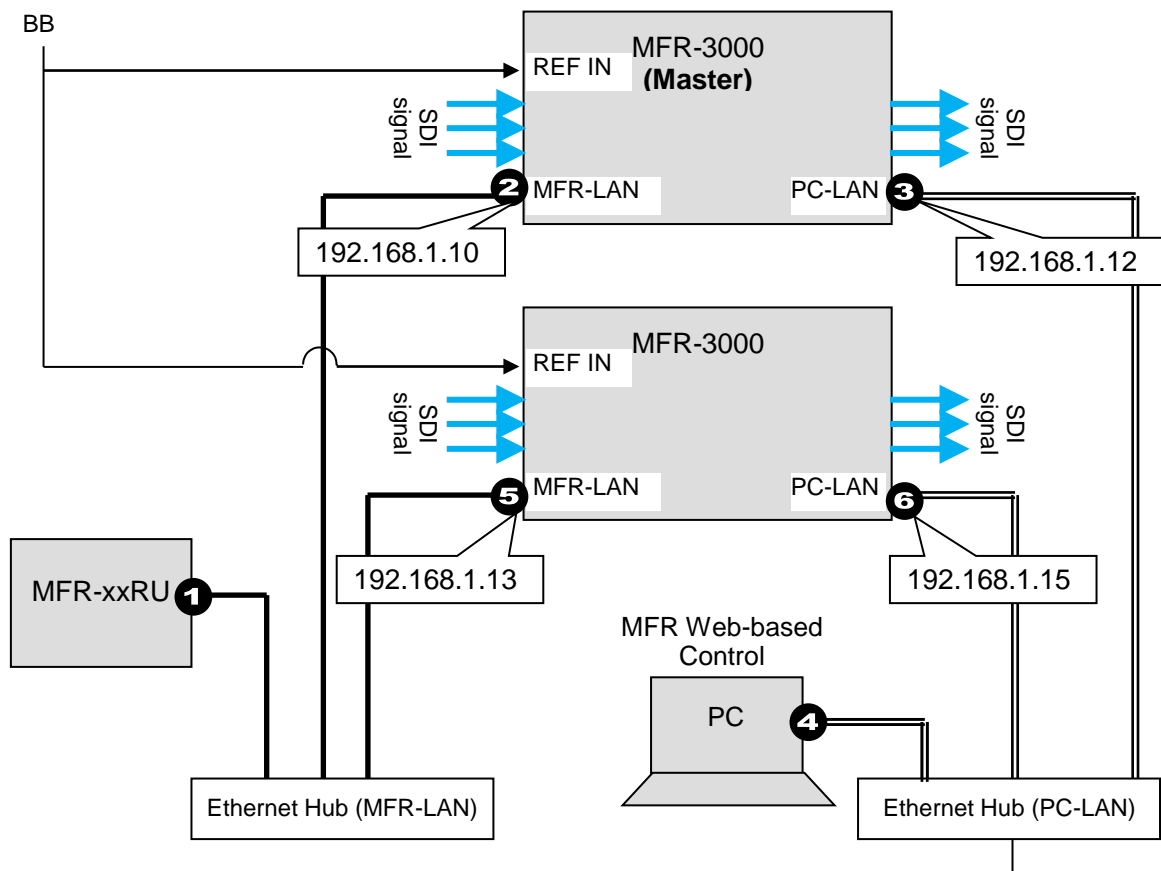

Note that in all MFR-3000 units the IP address of MFR-LAN1 is set to 192.168.1.10 and that of PC-LAN to 192.168.1.12 as factory default. To prevent IP address overlap in a system, you need to change IP addresses of either unit.

Also note that desired IP addresses can be set for system devices according to your network conditions.

◆ **Setup Procedure**

- 1) Connect all devices in the MFR system as shown in the figure in the previous page. Power on the MFR-3000 to be set as a Master, Remote Control unit and PC. Set the IP addresses for the Remote Control unit (①) and PC (④). Power off the MFR-3000.
- 2) Power on another MFR-3000. Set the IP addresses (⑤ and ⑥) as shown in the previous page.
- 3) Power on the Master MFR-3000.
- 4) Connect to the Master MFR-3000 Web-based control and open the **Build Setting** page. Check on **Build Enable** to enable the Main Unit Link feature.
- ▶ See Sec. 11 "Main Unit Link" in the "Web-based Control Operation Manual."

3-2-2. Expanded Matrix System Example

The system example below connects three MFR-3000 units to form a 128 x 32 virtual matrix.

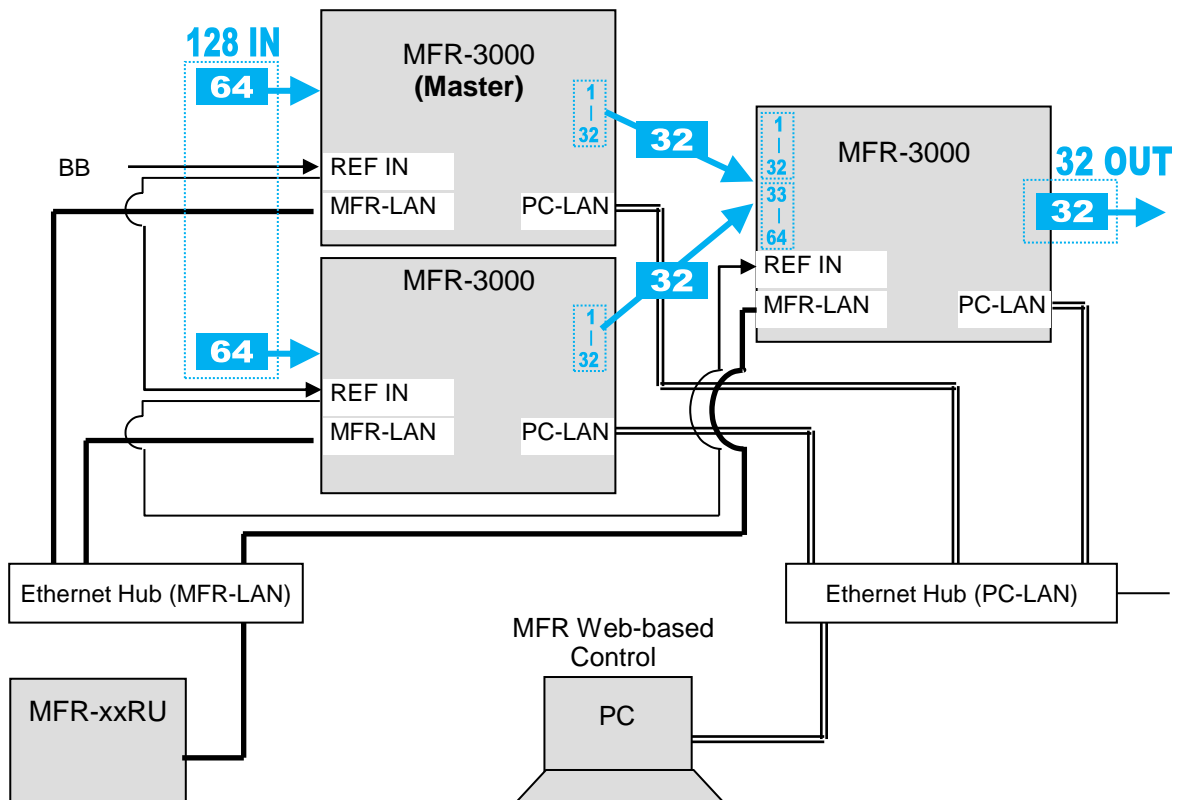

◆ **Setup Procedure**

- 1) Connect three MFR-3000 units, one by one, to the MFR system, referring to the previous chapter for details on to setting network settings. Do not use the same IP address twice in the system.
- 2) Connect all three MFR-3000 units to the MFR system. Connect BNC cables based on SDI signal routing paths.
- 3) Connect to the Web-based Control of an MFR-3000 and open the **Build Setting** page. Check on **Build Enable** to enable the Main Unit Link feature.
- ▶ See Sec. 11 "Main Unit Link" in the "Web-based Control Operation Manual."

3-3. Signal Name and Tally Link System

3-3-1. Standard Configuration

The block diagram below shows a basic signal name and tally link system.

To connect a video switcher via serial connection, use the MFR-3000 SERIAL port or SERIAL1-4 on MFR-GPI. The signal name and tally link system requires an RS-422 interface.

▶ See Sec. 2-3-4. or 2-7-4. "Switches on the Card."

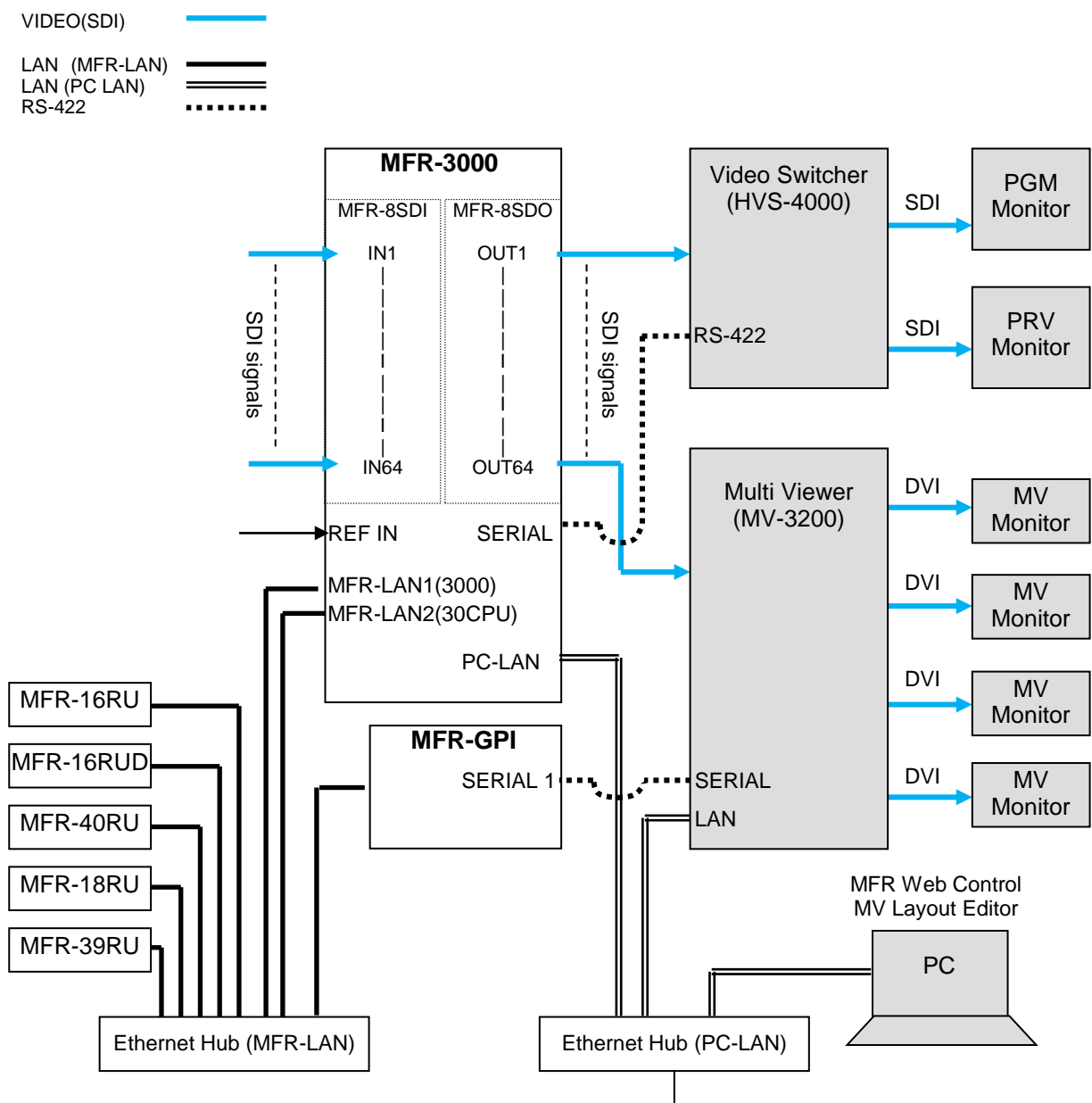

◆ **Transmitting Signal Name and Tally Data**

The figure below shows the routing of signal name and tally data.

Set each serial port following the table on this page using the MFR Web Control and on the switcher.
 Each tally information setting should be performed in the [Web-based Control:Tally System Settings page].

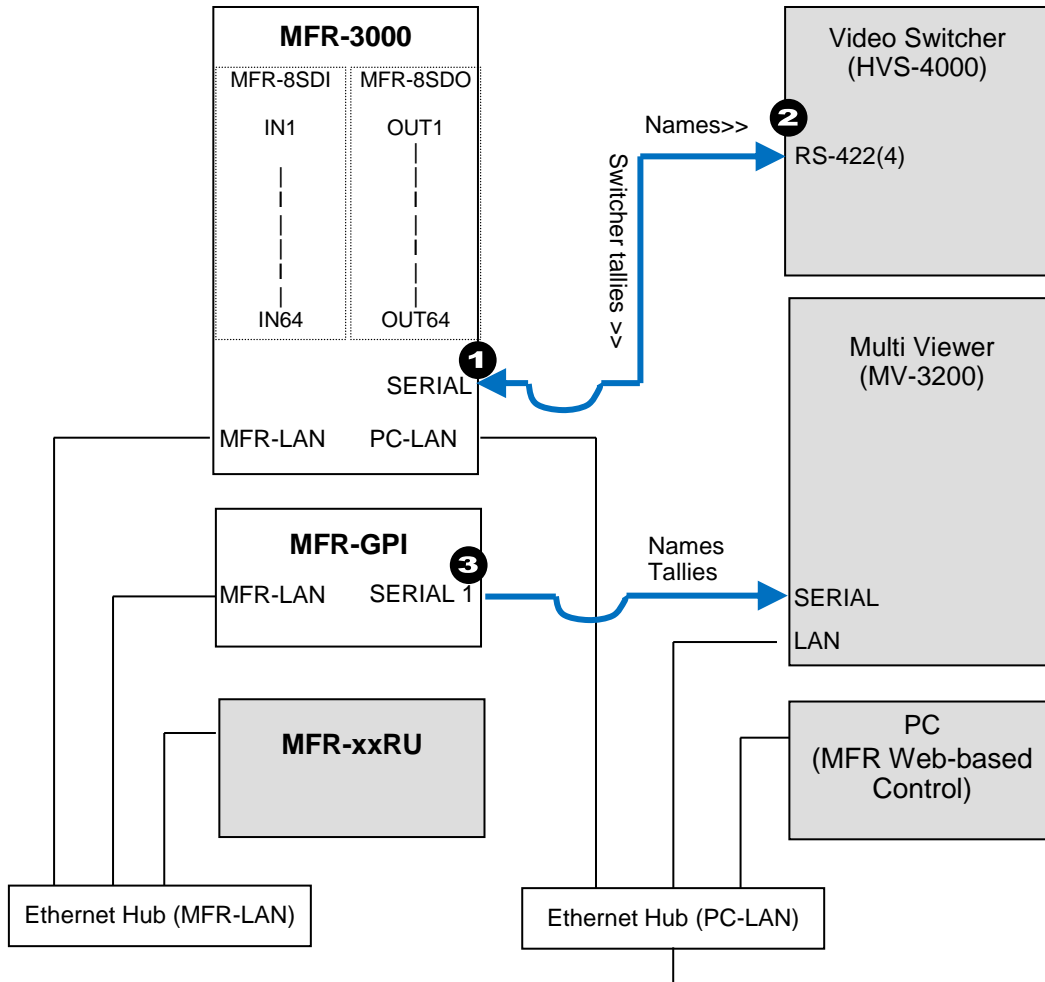

Serial Port Settings

Port	Menu	[Port Settings] - [Serial Port]			
		Connector	Function	Baud rate	Parity
❶	Web-based Control [Router System Settings]	(MU) -	Router/HVS connection type 2	38400	NONE
❷	HVS-4000 [EXT INTERFACE - RS-422]		ROUTER(Tx)	38400	NONE
❸	Web-based Control [Router System Settings]	(GPI) No. 1	Tally out (TSL Ver. 3.1)	38400	EVEN

Other Parameter Settings (in HVS-4000)

To send tallies to the router, set [TALLY ENABLE] in the ROUTER menu to [ON].

To receive source names from the router, set [SIGNAL ENABLE] in the ROUTER menu to [ON].

3-3-2. If Configuring an MFR-TALM

The block diagram below shows an example signal name and tally link system comprised of a FOR-A video switcher and multiviewer using an MFR-TALM unit. The MFR-TALM is specifically designed to perform the task of tally data computation, which is ordinarily undertaken by the MFR main unit, to accelerate the computation. RS-422 ports (1) to (4) are available for video switcher connection.

Before using an MFR-TALM unit for the system, change **Tally Control Unit** to **MFR-TALM** in the **[Main unit Web-based Control: MU Settings page]**.

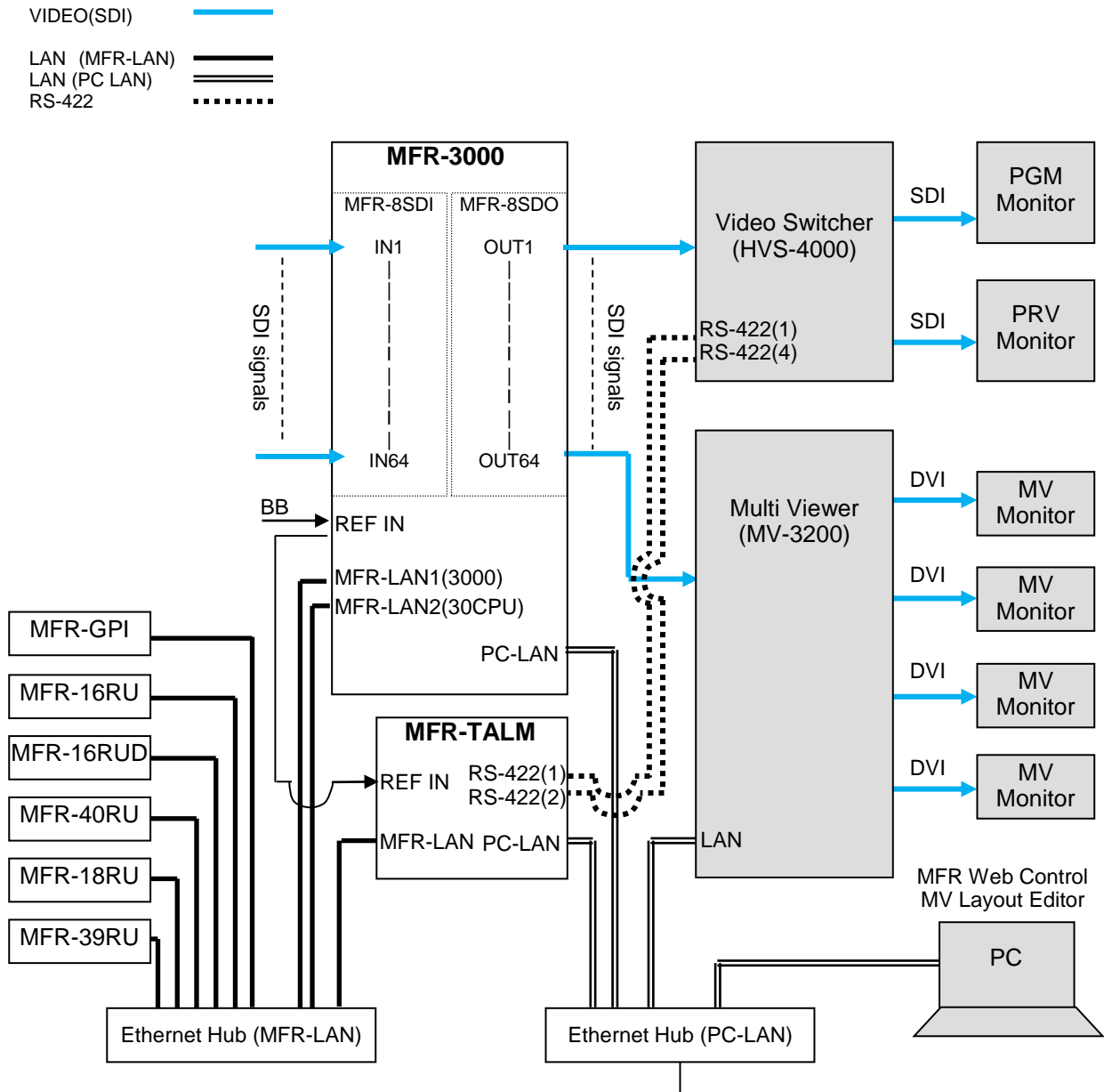

◆ **Transmitting Signal Name and Tally Data**

The figure below shows an example signal name and tally data routing system using the MFR-TALM.

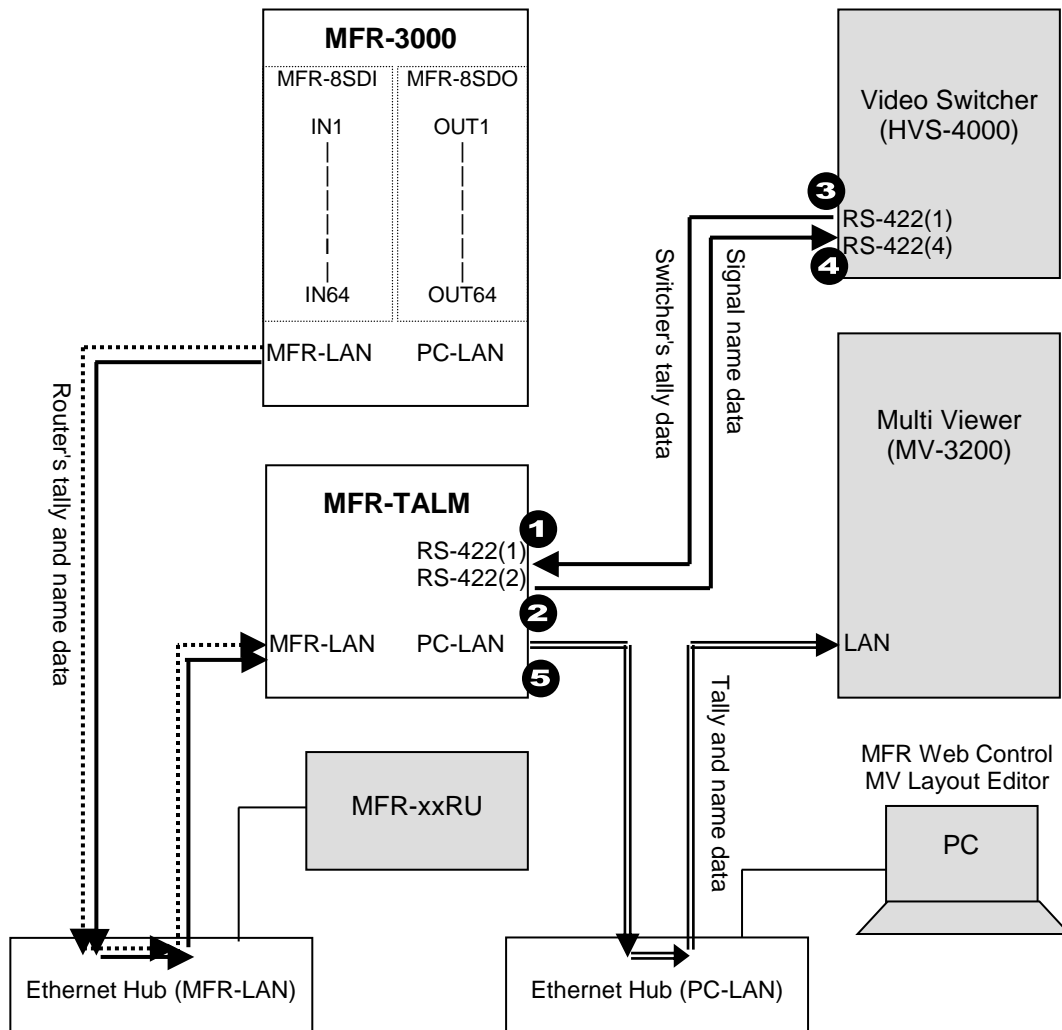

Each serial port should be set as shown in the table below in the relevant page of the **MFR-TALM** Web-based Control accessed from "<http://192.168.1.62>" (default IP address) on your web browser.

Serial Port Settings

Open the [MFR-TALM Web-based Control: **Port Settings** page] and perform port settings under **Serial Port**.

As for the HVS-4000 unit, perform port setting in the [EXT INTERFACE - RS-422] menu.

Port	Menu	[Port Settings] - [Serial Port]			
		Connector	Function	Baud rate	Parity
1	Web-based Control [TALM Settings]	No. 1	HVS-TAL Protocol Reception	38,400	EVEN
2	Web-based Control [TALM Settings]	No. 2	Router/HVS connection type 2	38,400	NONE
3	HVS-4000 [EXT INTERFACE - RS-422]	No. 1	TALLY	38,400	EVEN
4	HVS-4000 [EXT INTERFACE - RS-422]	No. 4	ROUTER (Tx)	38,400	NONE

TCP/IP Setting

Open the [MFR-TALM Web-based Control: **Port Settings** page] and perform port settings under **TCP/IP Port**.

Port	Menu	[Port Settings] - [TCP/IP Port]			
		Access Method	IP Address	Port	Function
5	Web-based Control [TALM Settings]	Client	(MV IP address)	(MV TCP/IP port number)	TSL UMD protocol V5.0 Tally out

Encode	DLE	Screen No.
Unicode	ON	(Set the same as in MV)

Data transmission settings between HVS-4000 and MFR-TALM

<HVS-4000-side>

- To send tally data to the router from the switcher. Set **TALLY ENABLE** in the ROUTER menu to **ON**.
- To receive name data from the router, set **SIGNAL ENABLE** in the ROUTER menu to **ON**.
- Perform the TALLY COLOR and TALLY UNIT 1, 3 and 5 settings so that the MFR-TALM unit can receive switcher tally data.

<MFR-TALM-side>

- Open the [MFR-TALM Web-based Control: **HVS-TAL Protocol Reception** page] and perform the same tally settings as those in HVS-4000.

The tally settings in the MFR system must be entered in the [MFR-TALM Web-based Control: **Tally System Settings** page]. When using MFR-TALM for tally control, the [Main unit Web-based Control: **Tally System Settings** page] and its subpages are all disabled. Refer to your multiviewer's user guide for the details on how to handle tally data on the multiviewer.

3-4. Switcher's AUX Crosspoints Switching System

This system enables the following two features:

- Switches AUX crosspoints on a switcher using an MFR Series Remote Unit or serial commands.
- Switches AUX crosspoints on a switcher as well as the corresponding crosspoints on the MFR-3000, if the MFR-3000 provides video sources to the switcher.

Supported switcher: **HVS-390HS**

◆ System Example

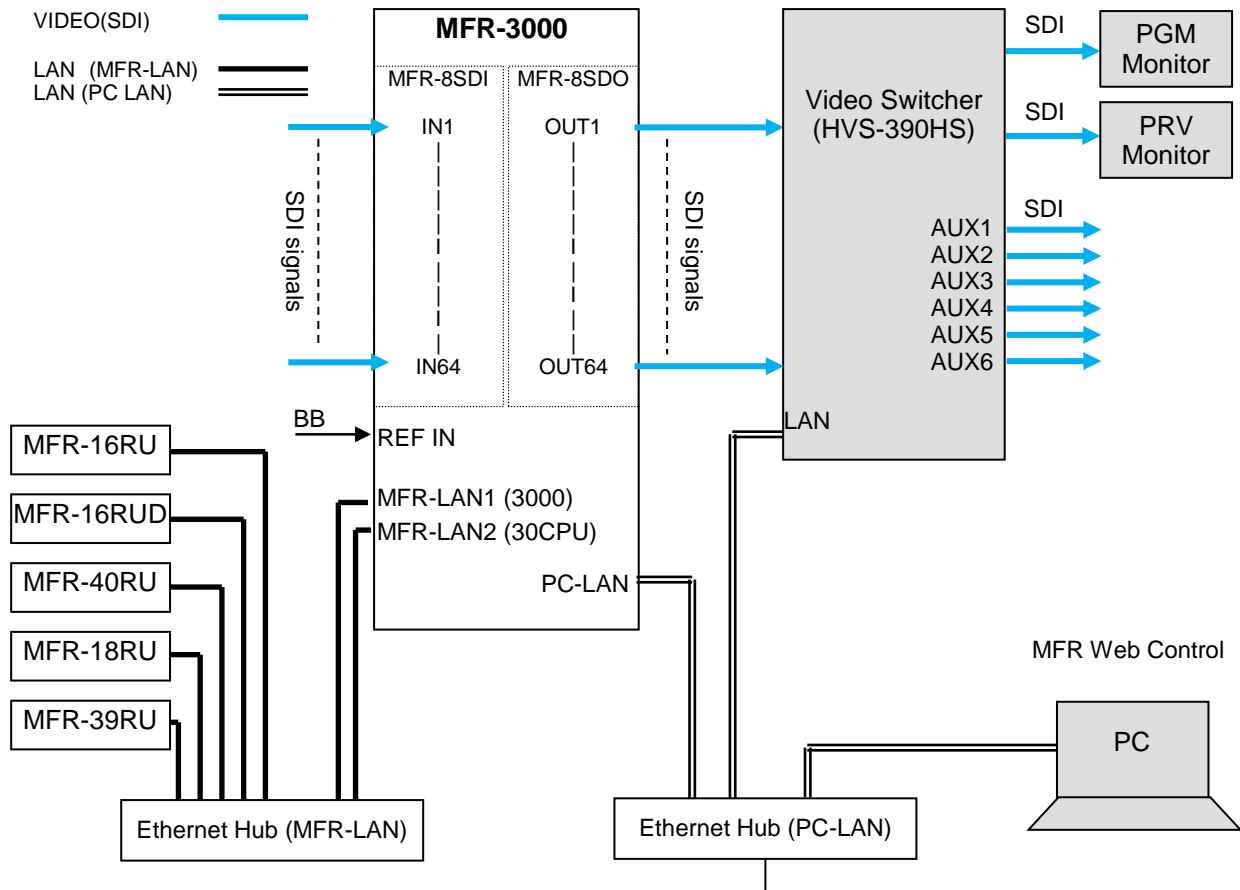

3-4-1. Switching an AUX Bus Signal

Assume that the system is configured as shown below:

AUX1 on the switcher is assigned to **DST 129** (Level 1) on the MFR-3000.

IN1-8 and **STL(Still) 3** on the switcher are assigned to **SRC129-137** on the MFR-3000.

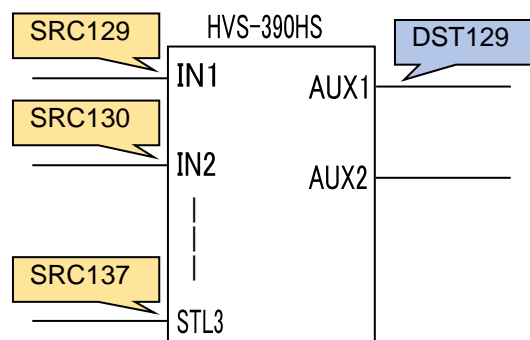

◆ **Setup Settings**

- 1) Connect and assign video signals as shown in the figure above.
- 2) Device Setup on the MFR-3000:
Connect to the MFR-3000 from the Web-based Control PC and open the [**Tally System Settings - Device Select**] page. Select **HVS-390HS** in the [**Switcher**] field and click [**Send**].
- 3) Network settings on the MFR-3000:
Open the [**Router System Settings - PortSettings**] page and set the TCP/IP menu as shown below.

IP Address	Port	Protocol	Function	Local Port(MFR)
(Switcher's IP address)	See below	UDP	Editor(HVS)	Select a UDP port number. Do not use the UDP port number (Default: 23) already used in the Server (MFR).

Switcher	Port
HVS-390HS	8740

- 4) Assign AUX buses and input channels on the switcher to logical destination and sources channels on the MFR-3000.

<AUX bus assignments>

- a) Open the **Destination Assignment** page.
- b) Select **HVS(AUX)** under **Select Table**.
- c) Set **Level** to **1**.
- d) Assign **AUX1** to **DST 129**.

<Input channel assignments>

- a) Open the **Source Assignment** page.
- b) Select **HVS(AUX)** under **Select Table**.
- c) Set **Level** to **1**.
- d) Assign input channels to MFR sources as shown below.

LogicalNo./Name	Switcher Channel
129 SRC 129	IN1
136 SRC 136	IN8
137 SRC 137	STL3

- 5) Settings on the switcher:
Open the [SETUP - EXT I/F - EDITOR] menu on the HVS-390HS.
Change [TYPE] to [**DVS**] and [ENABLE] to [**ON**].

After above setup settings are complete:

- If **SRC 129** is selected for **DST 129**, **AUX1** outputs **IN1** video on the switcher.
- If **SRC 137** is selected for **DST 129**, **AUX1** outputs **Still 3** video on the switcher.
- If **IN4** is selected for **AUX1** on the switcher, **SRC 132** is selected for **DST 129** on the MFR-3000.

If input channels that are not assigned in the **Source Assignment** page are selected on the switcher, they are replaced with the Alternative Source set in the **Source Assignment** page in the MFR system.

3-4-2. Synchronous Crosspoints Switching

- 1) to 3) Configure the system as described in Sec. 3-4-1.
- 4) Configure channel link settings:

Open the **Re-Entry** page and set the menu page as shown below.

Output	Input
Router OUT 61	HVS-390HS IN9 > AUX 1
Router OUT 62	HVS-390HS IN10 > AUX 2

- * Physical destination channels must be assigned to these logical destination channels on the MFR-3000.

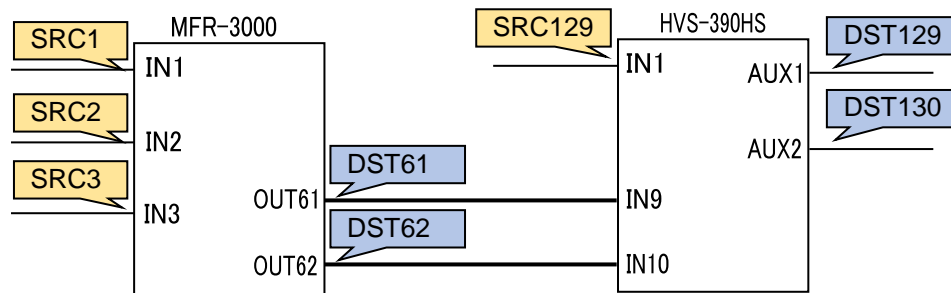

- 5) Assign logical source and destination channels on the MFR-3000 to input channels and AUX buses on the switcher.

<AUX bus assignments>

- a) Open the **Destination Assignment** page.
- b) Select **HVS(AUX)** under **Select Table**.
- c) Set **Level** to 1.
- d) Assign **AUX1** to **DST 129**.
- e) Assign **AUX2** to **DST 130**.

<Input channel assignments>

- a) Open the **Source Assignment** page.
- b) Select **HVS(AUX)** under **Select Table**.
- c) Set **Level** to 1.
- d) Assign **IN1** to **SRC 129**.

After above setup settings are complete:

- If **SRC 129** is selected for **DST 129** on the MFR-3000, **IN1** is selected for **AUX1** on the switcher.
- If **SRC 3** is selected for **DST 129** on the MFR-3000, **IN9** is selected for **AUX1** on the switcher and **SRC 3** is also selected for **DST 61** on the MFR-3000.
- If **IN9** is selected for **AUX1** on the switcher, a source assigned to **DST 61** is selected for **DST 129** on the MFR-3000
- If **IN10** is selected for **AUX2** on the switcher, a source assigned to **DST 62** is selected for **DST 130** on the MFR-3000

- * Note that destination channels to which physical channels are assigned (DST 61 and DST 62 in the example above) on the MFR-3000 cannot select source channels to which the switcher input channels are assigned (SRC 129 in the example above).
- * If an AUX crosspoint is switched on the switcher by the Synchronous Crosspoints switching and it is not listed in Re-Entry page, the AUX crosspoint returns to the previous state.

4. Front Panel (MFR-30FP) Operation

4-1. Functions and Operations

The below table shows the functions that can be controlled using the front panel and/or Web-based Control (GUI).

* For details on Web-based Control operation, see the separate MFR SERIES Web-based Control Operation Manual.

Description on Control

○: Changing settings and execution are both supported

●: Execution is supported

▲: Changing settings is supported

Function	Controller	Front Control Panel	Web-based Control	Ref.
Crosspoint change (1 channel)	By changing source and/or destination	○	○	6-1-1
	Using bus buttons	○	---	6-1-2
	Using the menu	○	---	4-4-3
	CHOP function	●	---	6-1-3
	TAKE function	●	○	6-1-4
Crosspoint change (Simultaneous)	Main unit stored SALVO	●	▲	6-2-1
	Front panel button assigned SALVO	●	▲	6-2-3
	TAKE function	●	○	6-2-4
	LINK function	●	▲	6-2-5
Erroneous operation protection	LOCK LOCAL	○	---	6-3-1
	LOCK OTHER/ALL	○	○	6-3-2
	Crosspoint inhibit	---	○	Web
	Operation Preview function	●	---	6-4
Main unit and system setting change	Source/destination name settings	---	○	Web
	System tally settings	---	○	Web
	MFR-LAN settings	▲	▲	4-4-6-2
	PC-LAN rebooting	▲	▲	4-4-6-3
Front panel setting change	Button assignment	○	○	4-4-4
	PAGE function	○	▲	Web
	Group setting	○	○	4-4-5
	Menu screen and button brightness adjustment	▲	▲	4-4-6-1
Status display		●	●	4-4-6-4
Alarm indication		●	●	4-4-6-4

4-2. Basic Operation on the Front Panel

This section describes the basic front panel operation and how to set and execute various functions.

4-2-1. Buttons

1) Assign functions to buttons (change assignments)

To use buttons on the front panel, assign functions to the buttons in the Web-based Control: **Assign Function** page]. Any function can be assigned to any buttons (see the figure below). Only lock functions can be assigned to the **LOCK** button.

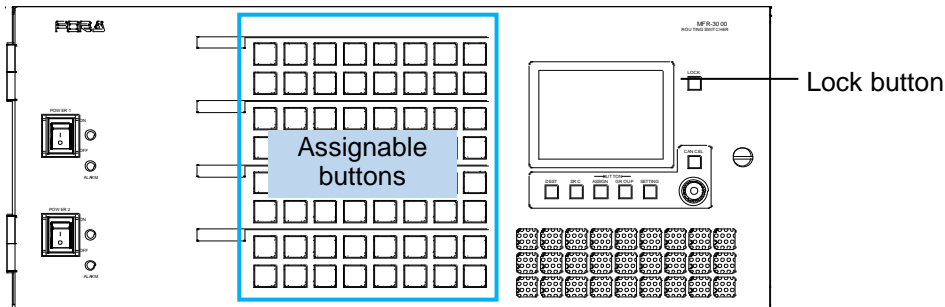

Button Assign Procedure

- (1) In the Web-based Control, click to open the MFR-3000 menu tree at the left side. Click to select **30FP Assign Function** to display the menu page.
- (2) Set the page, button and function respectively to assign functions to buttons. Buttons can be selected by specifying Button IDs or clicking on button icons.
- (3) After selecting a function, set the function specific settings.
- (4) After all settings are completed, click **Send** to apply the settings.

The front panel menu display can also assign functions.

► See Sec. 4-4-4 "Button Assign menu"

2) Press buttons to execute functions

Press a button to execute the assigned function. The button LED indication, NAME DISPLAY, and MENU display change according to the assigned function.

4-2-2. Page Function

By managing a set of front panel buttons as a page, page-assigned functions can be performed by a single button press. Pages can be changed by using the **PAGE** button (see Sec. 4-3 "Function Buttons").

4-2-2-1. Group Page Changes

Pages can be changed per a button group. Groupings from A to E can be freely changed using the Web-based Control menu.

► See Sec. 4-4-5. "Button Group menu" for more details on grouping.

Default front panel button groups are determined as shown in the figures below.

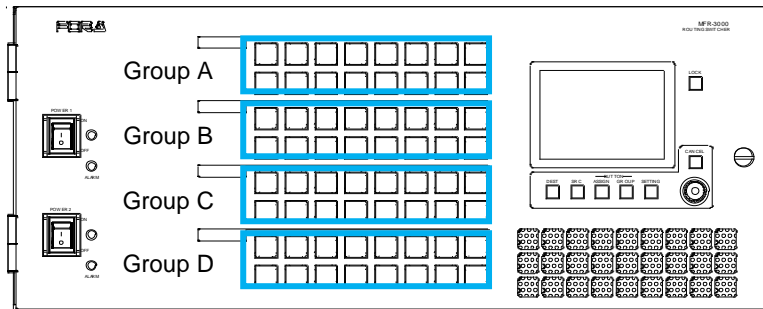

Page Limit and Maximum Page Number Setting

- The maximum number of assignable pages (page limit) is 32.
- The maximum number of pages, within which the page can be changed by the Mode menu or Page buttons, can be set within the page limit.
- The maximum page number setting is shared by all groups.
- Any page assignments or jumps are possible, but have no effect if they exceed the page limit.
- The maximum page number can be set under **Page-Max number** in the [Web-based Control: **30FP Settings** page]. A warning dialog box will appear when the number is reduced and sent.
- If the page limit is set to a number less than the displayed page, the displayed page will automatically change to the page number limit.

4-3. Function Buttons

Functions are assigned to buttons in the [Web-based Control: **30FP Assign Function** page] and available functions are as shown in the below table.

Function	Description	Refer to																
None	No function is assigned.																	
Destination	Allows you to change a destination to the destination specifically assigned to the button.	6-1-1																
Source	Allows you to change a source to the source specifically assigned to the button.	6-1-1																
Bus	Allows you to change a source to the source specifically assigned to the button for a destination of the source-destination assignment of the button.	6-1-2																
PAGE	Allows you to change pages to be displayed to a specific, next or previous page.	4-2-2																
LOCK	<p>The following 4 Lock modes can be set by pressing a button for either a short or a long time (more than 3 seconds).</p> <ul style="list-style-type: none"> -LOCK OTHER: Disables control from external devices. -LOCK ALL: Disables all controls. -LOCK LOCAL: Disables local control. -NONE <p>Assignable 2-way button functions (short and long press combinations) are as shown in the table below. Assign the functions to buttons in the Web-based Control menu.</p> <table border="1" style="width: 100%; border-collapse: collapse;"> <thead> <tr> <th style="width: 50%;">Short press function</th> <th style="width: 50%;">Long press function</th> </tr> </thead> <tbody> <tr> <td rowspan="2">LOCK OTHER</td> <td>NONE</td> </tr> <tr> <td>LOCAL</td> </tr> <tr> <td rowspan="2">LOCK ALL</td> <td>NONE</td> </tr> <tr> <td>LOCAL</td> </tr> <tr> <td rowspan="3">LOCK LOCAL</td> <td>NONE</td> </tr> <tr> <td>OTHER</td> </tr> <tr> <td>ALL</td> </tr> <tr> <td rowspan="3">NONE</td> <td>OTHER</td> </tr> <tr> <td>ALL</td> </tr> <tr> <td>LOCAL</td> </tr> </tbody> </table>	Short press function	Long press function	LOCK OTHER	NONE	LOCAL	LOCK ALL	NONE	LOCAL	LOCK LOCAL	NONE	OTHER	ALL	NONE	OTHER	ALL	LOCAL	<p>6-3-1 6-3-2</p>
Short press function	Long press function																	
LOCK OTHER	NONE																	
	LOCAL																	
LOCK ALL	NONE																	
	LOCAL																	
LOCK LOCAL	NONE																	
	OTHER																	
	ALL																	
NONE	OTHER																	
	ALL																	
	LOCAL																	
TAKE	Allows you to enable the TAKE function for simultaneous crosspoint changes.	6-1-4																
LINK	Allows you to enable or disable the LINK function.	6-2-5																
Operation Preview	Allows you to enable or disable the Operation Preview function.	6-4																
SALVO	Allows you to assign salvos to buttons and execute a salvo assigned to the button or stored in the main unit.	6-2-1 6-2-2																

4-4. Operation Using the Menu Display

The front panel allows button function and group assignments as well as destination channel selection and crosspoint change using the menu.

◆ Showing / hiding the menu display

To hide the menu display from the screen, press and hold **CANCEL** for five seconds.

To display a menu screen, press one of menu buttons below the screen.

Pressing the CONTROL knob also opens a menu screen.

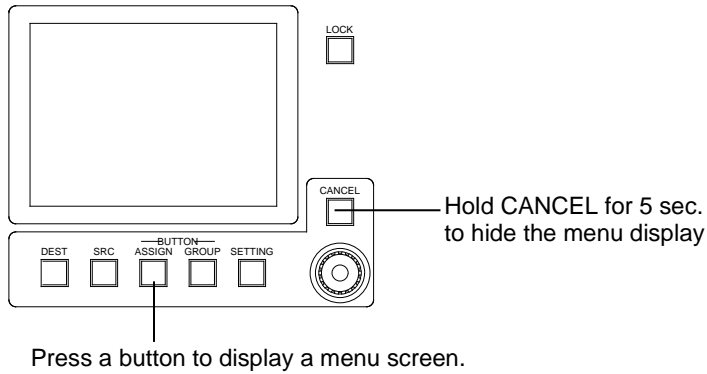

4-4-1. Destination menu

Pressing **DEST** opens the Destination menu.

The current destination channel is shown highlighted in the destination list.

To change the destination channel, turn the CONTROL knob.

<i>Destination</i>				
DST 1	DST 2	DST 3	DST 4	DST 5
DST 6	DST 7	DST 8	DST 9	DST10
DST11	DST12	DST13	DST14	DST15
DST16	DST17	DST18	DST19	DST20
DST21	DST22	DST23	DST24	DST25
DST26	DST27	DST28	DST29	DST30
DST31	DST32	DST33	DST34	DST35

4-4-2. Source menu

Pressing **SRC** opens the Source menu.

The current destination channel source is shown highlighted in the source list.

To change the destination channel source, turn **CONTROL**, then press **CONTROL**.

To cancel the operation process, press **CANCEL**.

<i>Source</i>				
SRC 1	SRC 2	SRC 3	SRC 4	SRC 5
SRC 6	SRC 7	SRC 8	SRC 9	SRC10
SRC11	SRC12	SRC13	SRC14	SRC15
SRC16	SRC17	SRC18	SRC19	SRC20
SRC21	SRC22	SRC23	SRC24	SRC25
SRC26	SRC27	SRC28	SRC29	SRC30
SRC31	SRC32	SRC33	SRC34	SRC35

4-4-3. Crosspoint menu

Simultaneously press **DEST** and **SRC** opens the Crosspoint menu.

The current destination channel is shown highlighted in the destination list.

The current destination channel and source are displayed at the upper right corner of the screen.

Destination selection screen

<i>Crosspoint</i>					DST 1	SRC 1
DST 1	DST 2	DST 3	DST 4	DST 5		
DST 6	DST 7	DST 8	DST 9	DST10		
DST11	DST12	DST13	DST14	DST15		
DST16	DST17	DST18	DST19	DST20		
DST21	DST22	DST23	DST24	DST25		
DST26	DST27	DST28	DST29	DST30		
DST31	DST32	DST33	DST34	DST35		

Source selection screen

<i>Crosspoint</i>					DST 1	SRC 1
SRC 1	SRC 2	SRC 3	SRC 4	SRC 5		
SRC 6	SRC 7	SRC 8	SRC 9	SRC10		
SRC11	SRC12	SRC13	SRC14	SRC15		
SRC16	SRC17	SRC18	SRC19	SRC20		
SRC21	SRC22	SRC23	SRC24	SRC25		
SRC26	SRC27	SRC28	SRC29	SRC30		
SRC31	SRC32	SRC33	SRC34	SRC35		

To change a crosspoint:

- (1) Turn **CONTROL** to select a destination channel.
- (2) Press **CONTROL** to display the source selection screen.
- (3) Turn **CONTROL** to select a source for the destination channel.
- (4) Press **CONTROL** to apply the crosspoint switch. The screen will return to Destination selection. (To cancel the process, press **CANCEL**.)

4-4-4. Button Assign menu

Pressing **BUTTON ASSIGN** opens the Button Assign menu.
 The selected button is shown highlighted green and its function is displayed in the right area.
 (See the table below for details on function parameter settings.)

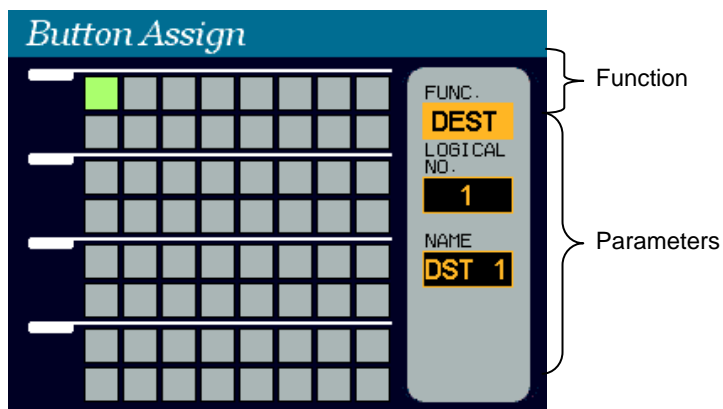

To change button function:

- (1) With holding down **CONTROL**, press a free button on the front panel.
 The button will blink. The current function is displayed in the right area.
- (2) Turn **CONTROL** to select a function, then press **CONTROL** to go to the parameter field.
- (3) Turn **CONTROL** to set the parameter value, then press **CONTROL** to go to the next parameter field. (See the table below for details on function parameter settings.)
- (4) Turn **CONTROL** to set the next parameter value (if necessary), then press **CONTROL**.
 (To cancel the process, press **CANCEL**.)

Assignable Function/Parameter List

Function	Parameter	Description
(NONE)	None	
DEST	LOGICAL NO. XXX	XXX: Destination Channel number
SRC	LOGICAL NO. YYY	YYYY: Source Channel number
BUS	DST NAME XXX	XXX: Destination Channel number
	SRC NAME YYY	YYYY: Source Channel number
PAGE	TYPE XX	XX: JUMP Goes to specified page UP Goes to next page. DOWN Goes to previous page.
	GROUP YYYYY	YYYYY: Group
	FWD: ZZ	ZZ: Specified page jump
	REV: WW	HOME: Returns to HOME page. WW: Page number
LOCK (Lock function by short press)	TYPE[S] XXX DEST[S] YYY	XXX: OTHER LOCK OTHER ALL LOCK ALL LOCAL LOCK LOCAL NONE No lock
	TYPE[L] XXX DEST[L] YYY	YYY: CURRENT Current Destination number Destination Channel number
		YYY is effective only when XXX is set to OTHER or ALL.
TAKE	None	
LINK	None	
PREVIEW	LOGICAL NO. XXX	XXX: Destination Channel number
SALVO	TYPE XX	XX: MU Main unit stored salvo FP Front panel button assigned salvo
	NO YYY	YYY: Salvo number

4-4-5. Button Group menu

Pressing **BUTTON GROUP** opens the Button Group menu.
The current groupings of free buttons are shown in 5 colors

To change a group of a button:

- (1) Turn **CONTROL** to select a free button on the screen, then press **CONTROL** to confirm the selection.
- (2) Turn **CONTROL** to select a group, then press **CONTROL** to confirm the change.

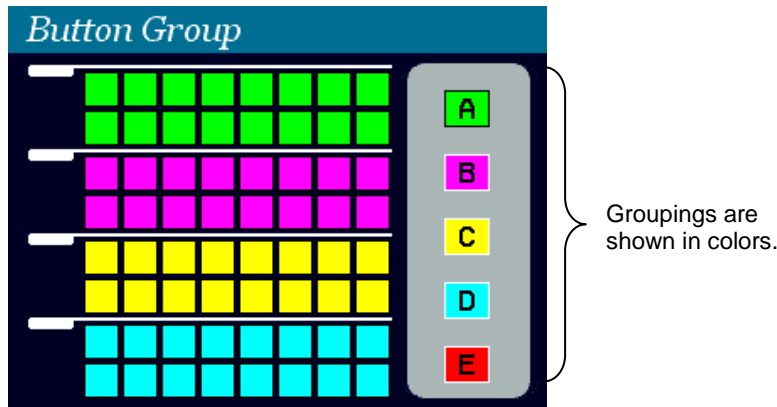

4-4-6. Setting menu

Pressing **SETTING** opens the SETTING menu that has 4 submenus.

To go to a submenu:

- (1) Turn **CONTROL** to select a submenu.
- (2) Press **CONTROL** to go to the submenu.

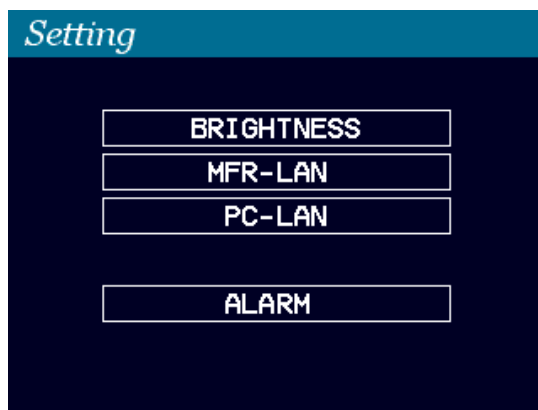

Submenu	Description
BRIGHTNESS	Used to change the brightness of menu screen and buttons.
MFR-LAN	Used to change network settings for the MFR-LAN1 and 2 ports.
PC-LAN	Used to display network settings for the PC-LAN port and reboot the PC-LAN port.
ALARM	Used to display the alarm information.

To set a parameter in submenus:

- (1) Turn **CONTROL** to select a parameter, then press **CONTROL**.
- (2) Turn **CONTROL** to select a value, then press **CONTROL** to confirm the setting.

4-4-6-1. BRIGHTNESS

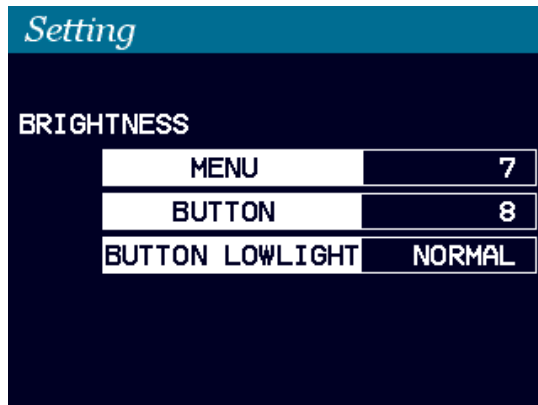

Parameter	Setting range	Description
MENU	1-16	Sets the menu screen brightness.
BUTTON	1-8	Sets the button brightness.
BUTTON LOWLIGHT	NORMAL LOWER	Allows you to select the low right.

4-4-6-2. MFR-LAN

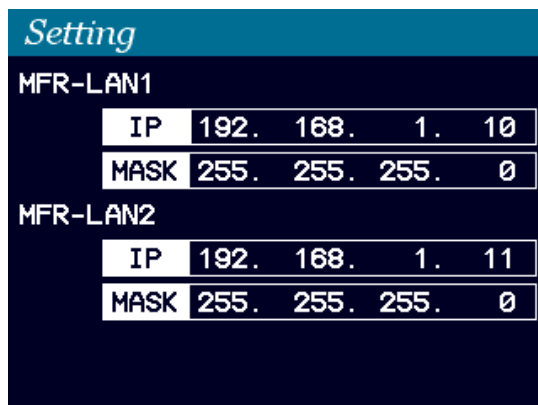

To change an MFR-LAN port settings:

- (1) Turn **CONTROL** to select an IP or mask, then press **CONTROL**.
- (2) Press **CONTROL** to select a number to be changed.
- (3) Turn **CONTROL** to change the number value, then press **CONTROL**.
- (4) After all settings are complete, turn **CONTROL** to select **APPLY?**, then press **CONTROL**.
- (5) Turn **CONTROL** to select **YES**, then press **CONTROL**.
- (6) Wait until the **RESTART THE MU** message appears. Reboot the Main Unit.
The new settings are applied when the Main Unit is rebooted.

4-4-6-3. PC-LAN

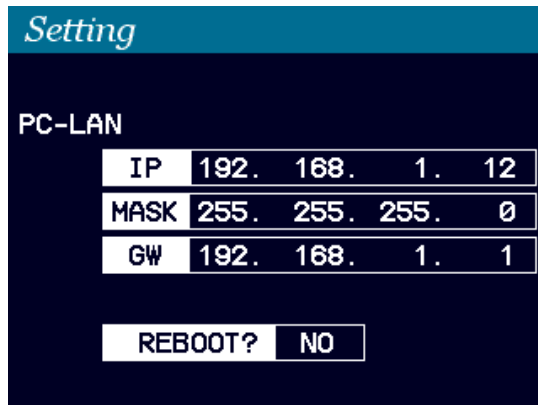

To change the PC-LAN port settings:

Refer to the procedure for MFR-LAN in the previous page to change settings.

To reboot the PC-LAN port:

- (1) Turn **CONTROL** to change **REBOOT** to **YES**.
- (2) Press **CONTROL** to reboot the PC-LAN port.

4-4-6-4. ALARM

If an alarm occurs, the menu display automatically shows the ALARM menu. Locate where the alarm comes from and take appropriate measures.

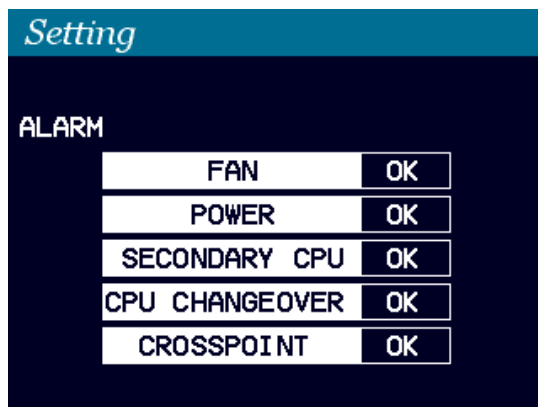

Display		Description
FAN	NG	Indicates that a fan (including power unit fans) alarm occurs.
POWER	NG	Indicates that a power alarm occurs.
SECONDARY CPU	NG	Indicates that an error occur in the secondary CPU.
CPU CHANGEOVER	NG	Indicates that the secondary CPU is active.
CROSSPOINT	NG	Indicates that a crosspoint error occurs.

5. Remote control panel Operation

5-1. Functions and Operations

The below table shows the functions that can be controlled using the remote control panel (RU) and/or Web-based Control (GUI).

* For details on Web-based Control operation, see the separate MFR SERIES Web-based Control Operation Manual.

Description on Control

○: Changing settings and execution are both supported

●: Execution is supported

▲: Changing settings is supported

39: Supported by the MFR-39RU, MFR-39RUA

18: Supported by the MFR-18RU, MFR-18RUA

16D: Supported by the MFR-16RUD

16T: Supported by the MFR-16RUTA

Function	Controller	Remote Control Units	Web-based Control	Ref.
Crosspoint change (1 channel)	By changing source and/or destination	○	○	6-1-1
	Using bus buttons	○	---	6-1-2
	Using buttons and the CONTROL knob	18, 16T	---	5-4-2
	Using the display	16D	---	5-5-1
	CHOP function	●	---	6-1-3
	TAKE function	●	○	6-1-4
Crosspoint change (Simultaneous)	Main unit stored SALVO	●	▲	6-2-1
	Control panel button assigned SALVO	39, ●	▲	6-2-2
	TAKE function	●	○	6-2-4
	LINK function	●	▲	6-2-5
Erroneous operation protection	LOCK LOCAL	○	---	6-3-1
	LOCK OTHER/ALL	○	○	6-3-2
	Crosspoint inhibit	---	○	Web
	Operation Preview function	●	---	6-4
Main unit and system setting change	Source/destination name settings	---	○	Web
	System tally settings	---	○	Web
Remote control setting change	Mode menu	39, 18, 16T	---	5-4-2
	Button assignment	39, 18, 16T ^(*) 16D	○	5-4-3-12 (5-4-2)
	PAGE function	○	---	5-2-2
	Group setting	---	○	5-2-2-1
	Multi-remote control panel operation	39 ^(*)	▲	5-11-2
	IP address setting	▲	▲	5-6-1
	Other settings	39	○	5-4-3 5-6
Status display		●	●	---
Alarm indication		●	●	---

^(*) Source and destination button/channel assignments can be performed using **CONTROL** on MFR-18RU/16RUTA/18RUA/39RUA units.

^(*) MFR-39RU/39RUA can change multi-remote control panel operation settings while other remote control panels can only be used for operation.

5-2. Basic Operation on Control Panels

This section describes basic operation of the remote control panel and how to set and execute various functions.

5-2-1. Buttons

1) Assign functions to buttons (change assignments)

To use buttons on the remote control panel, assign functions to the buttons in the Web-based Control: **Assign Function** page]. Any function can be assigned to any button except the **CANCEL**, **PAGE A**, **PAGE B**, **UP**, **DOWN** and **ENTER** buttons.

Button Assign Procedure

- (1) In the Web-based Control, click to open the menu tree at the left side. Click to select **Assign Function** to display the menu page.
- (2) Set the page, button and function respectively to assign functions to buttons. Buttons can be selected by specifying Button IDs or clicking on button icons.
- (3) After selecting a function, set the function specific settings.
- (4) After all settings are completed, click **Send** to apply the settings.

The MFR-39RU menu display can also assign functions.

- ▶ See Sec. 5-4-3-12 "BTN ASSIGN"

The MFR-39RUA menu display can also assign functions.

- ▶ See section 5-4-4-4 "BUTTON ASSIGN"

Source and destination button/channel assignments can be performed using **CONTROL** on MFR-18RU / 16RUTA / 18RUA / 39RUA units.

- ▶ See Sec. 5-2-3. "Control Knob"

MFR-16RUD can perform assignments using the display on the front panel.

- ▶ See Sec. 5-2-2 "Changing Button Assignments" for details

2) Press buttons to execute functions

Press a button to execute the assigned function. The button LED indication, NAME DISPLAY, and MENU display change according to the assigned function.

5-2-2. Page Function

By managing a set of remote control panel front panel buttons as a page, page-assigned functions can be performed by a single button press. Pages can be changed either by using the **PAGE** button (see Sec. 5-3 "Function Buttons") or the control knob by changing the Mode. (See Sec. 5-4 "MODE Button and Mode Menu (MFR-39RU/18RU/16RUTA)".)

There also are settings for the Page function in the Mode and Setting menus. Please also refer to the following sections.

- For **PAGE** button assignment: 5-4-3-5 "PAGE ASSIGN"
This section describes the setting for whether to assign the **PAGE** button in all pages. Having **PAGE** buttons assigned to all pages helps you not to have to look for the **PAGE** button.
- For Mode menu settings: 5-4-3-4 "PAGE MODE"
This section describes how to select pages using the control knob.

5-2-2-1. Group Page Changes

Pages can be changed per a button group. The number of available button groups differ depending on a remote control unit as shown in the table below. These groupings can be freely changed using the Web-based Control menu.

Remote Control Unit	Button group
MFR-16RU/16RUD	A to B
MFR-16RUW/32RUW	A to C
MFR-39RU/40RU/18RU/16RUTA/39RUA/18RUA	A to D
MFR-64RUW	A to E

Default button groups of control panels are determined as shown in the figures below.

MFR-39RU

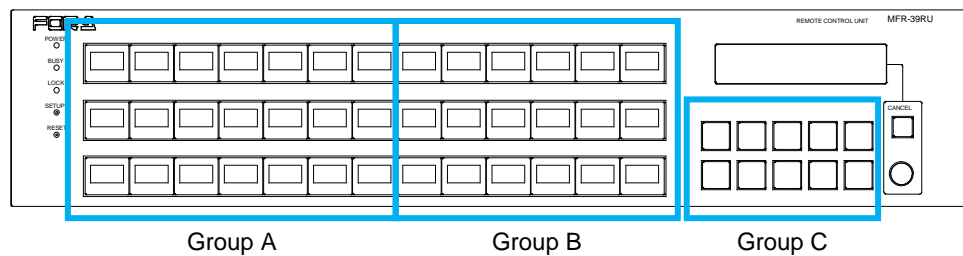

MFR-39RUA

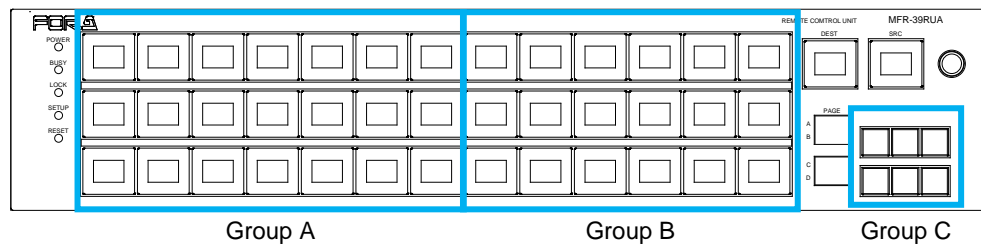

MFR-40RU

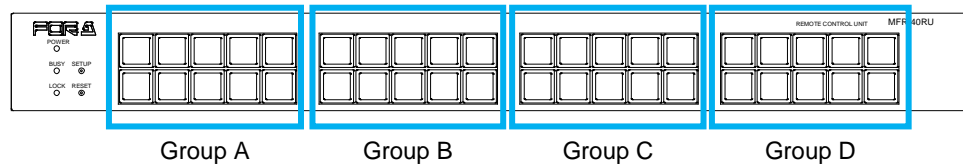

MFR-18RU/18RUA

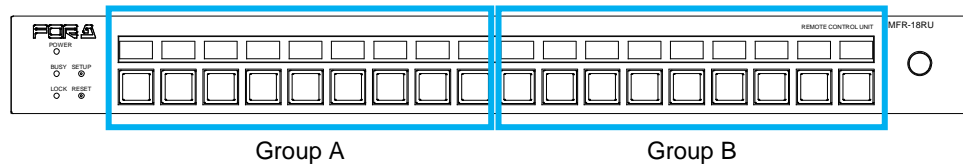

MFR-16RU

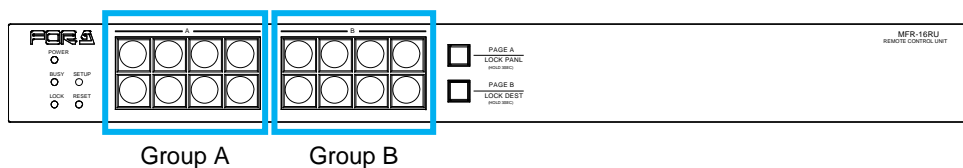

MFR-16RUD

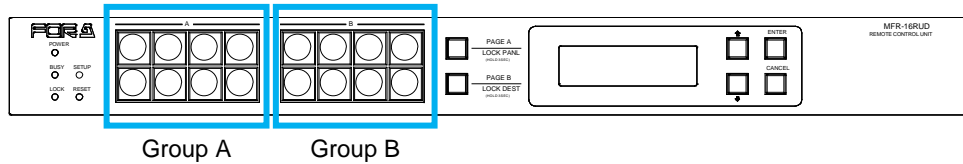

MFR-16RUW

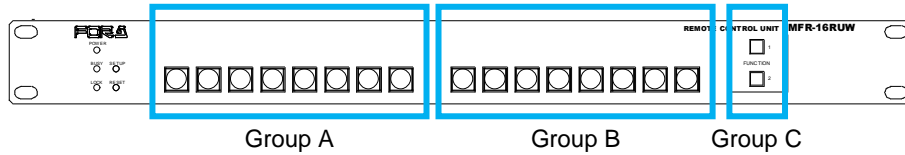

MFR-32RUW

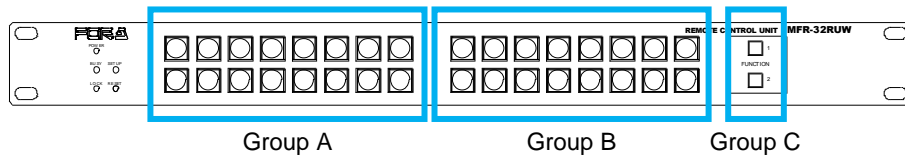

MFR-64RUW

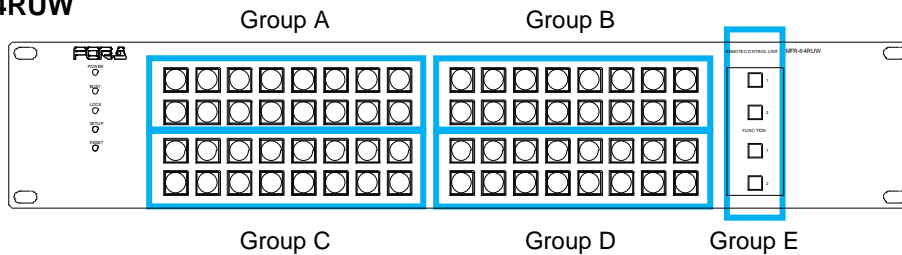

MFR-16RUTA

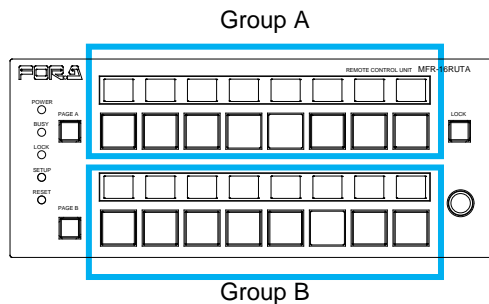

Page Limit and Maximum Page Number Setting

- The maximum number of assignable pages (page limit) is:

32 for MFR-39RUA /18RUA /39RU /40RU /18RU /16RUW /32RUW /64RUW /16RUTA
2 for MFR-16RU/16RUD

- The maximum number of pages, within which the page can be changed by the Mode menu or Page buttons, can be set within the page limit (excluding MFR-16RU/16RUD).

- The maximum page number setting is shared by all groups.

- Any page assignments or jumps are possible, but have no effect if they exceed the page limit. ("x" will appear instead of buttons on the MFR-39RUA/18RUA/39RU/18RU/16RUTA units.)

- The maximum page number can be set under **Page-Max number** in the [Web-based Control: **RU Settings** page]. A warning dialog box will appear when the number is reduced and sent.

- If the page limit is set to a number less than the displayed page, the displayed page will automatically change to the page number limit.

5-2-3. Control Knob

If your MFR Remote control panel has a control knob, you can select destination channels or other items using the knob.

You can also select menu items by turning and pressing the knob to confirm the selection. Using the control knob, it is easy to select items to be displayed or to change settings by changing modes in the Mode menu. See Sec. 5-4 “MODE Button and Mode Menu (MFR-39RU/18RU/16RUTA/39RUA/18RUA)”

MFR-39RUA

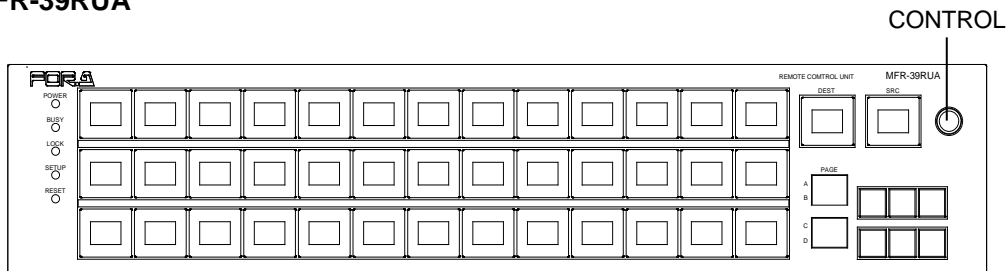

MFR-18RU

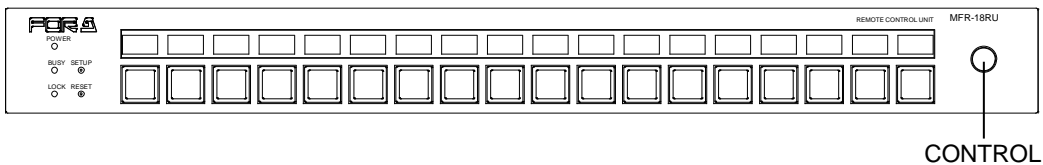

MFR-39RU

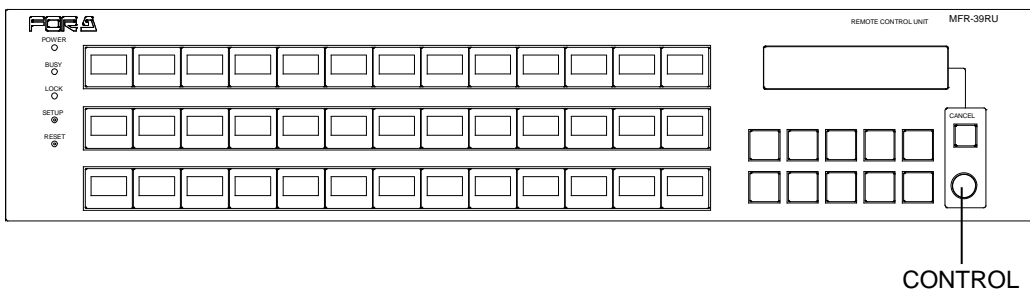

MFR-16RUTA

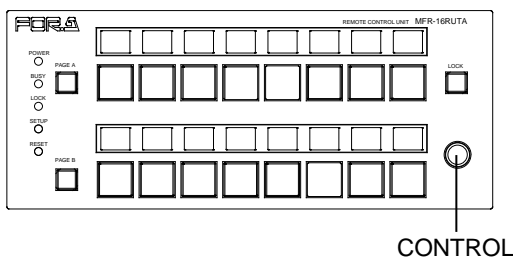

* The Control knob can be disabled or enabled in the [Web-based Control: **RU Settings** page]

Selecting a source or non-function button on MFR-18RU/16RUTA/39RUA/18RUA units allows you to change the source channel assignment.

Selecting a destination button allows you to perform one of the following three operations set in the **RU Settings** page. (MFR-39RUA units perform **Assign** operations.)

- **Assign** (default): Allows you to change the channel assignment of the selected destination button.
- **Crosspoint**: Allows you to change the crosspoint assignment of the selected destination button.
- **Disable**: The operation is disabled.

The operation procedure is as follows:

- (1) Press the desired source, destination or non-function button while holding down the control knob. The button light sequentially changes its color from red to orange, then green.

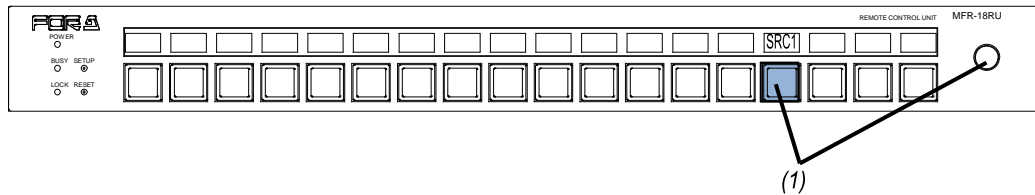

- (2) Turn the control knob to select a source channel to assign to the button.

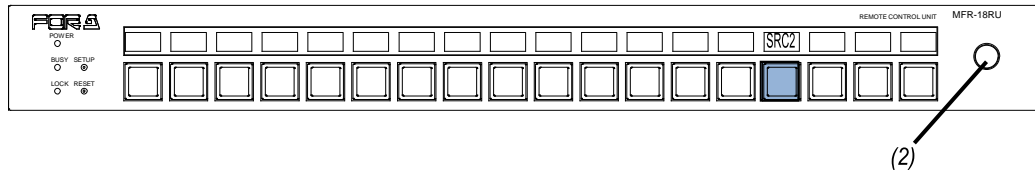



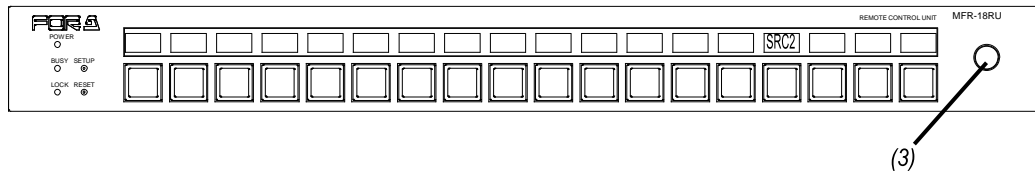









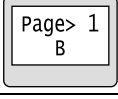
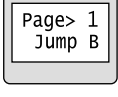
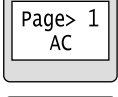
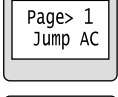
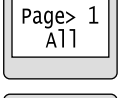
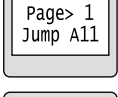
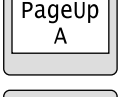
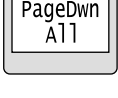

- (3) Press the control knob to confirm the change. To cancel the change, press the selected source button. After confirming or canceling the change, the button light returns to the previous state.

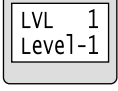
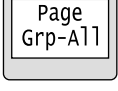



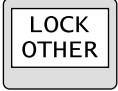

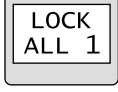



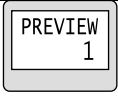

5-3. Function Buttons

Functions that are assignable to Remote control panel buttons are as shown in the below table. Normally, functions are assigned via Web-based Control. MFR-39RU menu display is enabled to assign functions. See the separate Web-based Control Operation Manual or section 5-4-3-12. "BTN ASSIGN" for details.

Function	Button indication	Description	Reference													
None		No function is assigned.														
Destination		Allows you to change a destination to the destination specifically assigned to the button. If locked, the button lights up with a color indicating LOCK OTHER or LOCK ALL, which can be set in the [Web-based Control: RU Settings page]. Re-pressing the button allows you to display the Unit ID that locks the destination button.	6-1-1													
Source		Allows you to change a source to the source specifically assigned to the button.	6-1-1													
Bus		Allows you to change a source to the source specifically assigned to the button for a destination of the source-destination assignment of the button.	6-1-2													
PAGE	       	<p>Allows you to change pages to be displayed to a specific, next or previous page. There is a menu that allows you to select whether to return to the previously displayed page or to display the next specified page. Target group(s) is/are displayed on the bottom of the button indication.</p> <p>See Sec. 5-2-2. "Page Function" and Appendix: "How to use Page buttons" for details on Page button setting and operation</p> <p>* Button indications (from the top to the bottom)</p> <table border="1"> <tbody> <tr> <td>PAGE JUMP (single)</td> <td rowspan="2">Switches the page to 1 for Group B.</td> </tr> <tr> <td>PAGE JUMP (single) (*1)</td> </tr> <tr> <td>PAGE JUMP (multi)</td> <td rowspan="2">Switches the page to 1 for Group A and C.</td> </tr> <tr> <td>PAGE JUMP (multi) (*1)</td> </tr> <tr> <td>PAGE JUMP (all)</td> <td rowspan="2">Switches the page to 1 for all groups.</td> </tr> <tr> <td>PAGE JUMP (all) (*1)</td> </tr> <tr> <td>PAGE UP (single)</td> <td>Moves the page forward by 1 for Group A.</td> </tr> <tr> <td>PAGE DOWN (all)</td> <td>Moves the page backward by 1 for all groups.</td> </tr> </tbody> </table> <p>* A corresponding page name is displayed when assigning PAGE JUMP on MFR-18RUA/39RUA/16RUTA units.</p> <p>(*1) MFR-18RUA/39RUA/16RUTA only</p>	PAGE JUMP (single)	Switches the page to 1 for Group B.	PAGE JUMP (single) (*1)	PAGE JUMP (multi)	Switches the page to 1 for Group A and C.	PAGE JUMP (multi) (*1)	PAGE JUMP (all)	Switches the page to 1 for all groups.	PAGE JUMP (all) (*1)	PAGE UP (single)	Moves the page forward by 1 for Group A.	PAGE DOWN (all)	Moves the page backward by 1 for all groups.	5-2-2
PAGE JUMP (single)	Switches the page to 1 for Group B.															
PAGE JUMP (single) (*1)																
PAGE JUMP (multi)	Switches the page to 1 for Group A and C.															
PAGE JUMP (multi) (*1)																
PAGE JUMP (all)	Switches the page to 1 for all groups.															
PAGE JUMP (all) (*1)																
PAGE UP (single)	Moves the page forward by 1 for Group A.															
PAGE DOWN (all)	Moves the page backward by 1 for all groups.															

Function	Button indication	Description	Reference																											
MODE	    	<p>* Supported for MFR-39RU/ 18RU/ 16RUTA/ 39RUA/ 18RUA.</p> <p>Allows you to change mode menus.</p> <p>Mode function can be assigned to either one or multiple buttons. One button assignment allows you to change modes one by one by every press.</p> <p>To assign modes to respective buttons, select modes in the BTN ASIGN menu.</p> <p>* Button indications (from the top to the bottom)</p> <table border="1"> <tr> <td>Destination mode</td> <td></td> </tr> <tr> <td>Source mode</td> <td></td> </tr> <tr> <td>Level mode</td> <td></td> </tr> <tr> <td>Page mode ^(*) (PAGE_Grp-All / A / B / C / D)</td> <td>* The example at left shows the PAGE_Grp-All mode</td> </tr> <tr> <td>Setting mode</td> <td></td> </tr> </table> <p>^(*) The name set under Page Name Settings is displayed for PAGE_Grp-A/B/C/D. (MFR-39RUA/18RUA/16RUTA only)</p>	Destination mode		Source mode		Level mode		Page mode ^(*) (PAGE_Grp-All / A / B / C / D)	* The example at left shows the PAGE_Grp-All mode	Setting mode		5-4																	
Destination mode																														
Source mode																														
Level mode																														
Page mode ^(*) (PAGE_Grp-All / A / B / C / D)	* The example at left shows the PAGE_Grp-All mode																													
Setting mode																														
LOCK	 (A)  (B)  (C)  (C)'  (D)  (D)'	<p>The following 4 Lock modes can be set by pressing a button for either a short or a long time (more than 3 seconds).</p> <p>-LOCK OTHER: Disables control from external devices. -LOCK ALL: Disables all controls. -LOCK LOCAL: Disables local control. -NONE</p> <p>Assignable 2-way button functions (short and long press combinations) are as shown in the table below. Assign the functions to buttons in the Web-based Control menu.</p> <table border="1"> <thead> <tr> <th>Short press function</th> <th>Long press function</th> <th>Button indication</th> </tr> </thead> <tbody> <tr> <td rowspan="2">LOCK OTHER</td> <td>NONE</td> <td>(C) or (C)' (*1)</td> </tr> <tr> <td>LOCAL</td> <td>(A) (*2)</td> </tr> <tr> <td rowspan="2">LOCK ALL</td> <td>NONE</td> <td>(D) or (D)' (*1)</td> </tr> <tr> <td>LOCAL</td> <td>(A) (*2)</td> </tr> <tr> <td rowspan="3">LOCK LOCAL</td> <td>NONE</td> <td>(B)</td> </tr> <tr> <td>OTHER</td> <td>(A) (*2)</td> </tr> <tr> <td>ALL</td> <td>(A) (*2)</td> </tr> <tr> <td rowspan="3">NONE</td> <td>OTHER</td> <td>(C) or (C)' (*1)</td> </tr> <tr> <td>ALL</td> <td>(D) or (D)' (*1)</td> </tr> <tr> <td>LOCAL</td> <td>(B)</td> </tr> </tbody> </table> <p>(*1) Button indications differ depending on the current or fixed destination.</p> <p>(*2) The button indication changes if enabling either function, for example, if a combination of LOCK OTHER (short press) and LOCK LOCAL (long press) functions are assigned to a button, long pressing the button changes the indication to LOCK LOCAL.</p>	Short press function	Long press function	Button indication	LOCK OTHER	NONE	(C) or (C)' (*1)	LOCAL	(A) (*2)	LOCK ALL	NONE	(D) or (D)' (*1)	LOCAL	(A) (*2)	LOCK LOCAL	NONE	(B)	OTHER	(A) (*2)	ALL	(A) (*2)	NONE	OTHER	(C) or (C)' (*1)	ALL	(D) or (D)' (*1)	LOCAL	(B)	6-3-1 6-3-2
Short press function	Long press function	Button indication																												
LOCK OTHER	NONE	(C) or (C)' (*1)																												
	LOCAL	(A) (*2)																												
LOCK ALL	NONE	(D) or (D)' (*1)																												
	LOCAL	(A) (*2)																												
LOCK LOCAL	NONE	(B)																												
	OTHER	(A) (*2)																												
	ALL	(A) (*2)																												
NONE	OTHER	(C) or (C)' (*1)																												
	ALL	(D) or (D)' (*1)																												
	LOCAL	(B)																												
TAKE		Allows you to enable the TAKE function for simultaneous crosspoint changes.	6-1-4																											

LEVEL		Allows you to change a level to the level specifically assigned to the button.	6-5
LINK		Allows you to enable or disable the LINK function.	6-2-5
TENKEY		Allows you to enable numeric keypad mode on the remote control panel for assigning destinations and source by their channel numbers. * Supported only for MFR-39RU and MFR-39RUA.	6-1-1-2
SKIP	 	Allows you to skip the set number of destination or source channels forward or backward to select one. * The control knob needs to be pressed for Source selections. * Button indications Top: Channel number increases in the set step Bottom: Channel number decreases in the set step * Supported only for MFR-39RU/18RU/16RUTA/39RUA/18RUA.	6-1-1-1
Operation Preview		Allows you to enable or disable the Operation Preview function.	6-4
SALVO	  	Allows you to assign salvos to buttons and execute a salvo assigned to a button or stored in the main unit. * Button indications Top: Salvo Store – Allows you to assign salvos to buttons. Middle: Salvo Recall (MU) – Executes a main unit-stored salvo Bottom: Salvo Recall (RU) – Executes a button-assigned salvo	6-2-1 6-2-2
Display Mode	 	* MFR-18RU/16RUTA/18RUA only Allows you to change button indication between Destination and Source channel names. <Button indication> Top: DST NAME Bottom: SRC NAME	

◆ Destination Button LCD Indication

Usually destination channel names are displayed on the LCD above the destination buttons. The MFR-18RU can also display source channel names that are selected for destinations. To display source channel names, set the menu under **Display Setting** in the [Web-based Control: **RU Settings** page]. Note that Display Mode buttons on MFR-18RU/16RUTA units can switch the button indication between destination and source names.

In the case of breakaway switching with multiple levels, the name of the level with the smallest number will be displayed.

● MFR-18RU



- MFR-16RUTA

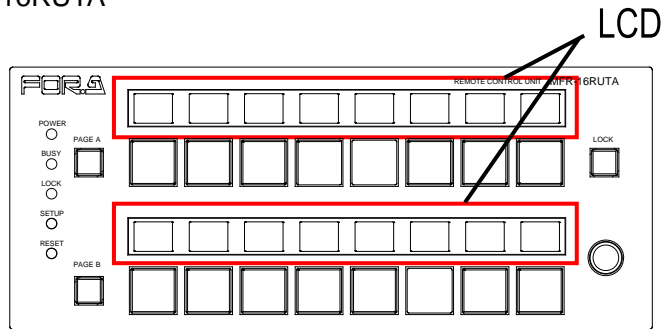

5-4. MODE Button and Mode Menu (MFR-39RU/18RU/16RUTA/39RUA/18RUA)

5-4-1. Outline

The **MODE** button allows you to select different setting modes. As the setting mode changes available items on the MENU and LCD displays and for the control knob change.
(Supported only for MFR-39RU/18RU/16RUTA/39RUA/18RUA.)

Modes are selectable for assignment. Assign only necessary modes to allow for easier searches.

Multiple buttons can be assigned to **MODE** buttons. If multiple **MODE** buttons are assigned, the **MODE** button will be highlighted (the text background illuminates) when it is pressed.

5-4-2. Mode Menu

The Mode menu has 5 mode options. Only MFR-39RU and MFR-39RUA units are able to use Setting mode.

◆ Destination Mode

MENU: Displays the current destination channel [name] and its level [name].

LCD: Displays the current destination channel.

Current DEST button: Displays the current destination channel. Pressing the button shift the status display between LEVEL and LOCK.

Turning the knob: Changes the current destination channel.

DST :	1	[DST1]
LVL :	0001	[Level-1]

Menu display



Button LCD / Current DEST button (39RUA only)

◆ **Source Mode**

MENU: Displays the source channel [name] for the current destination.

LCD: Displays the source channel for the current destination.

Current SRC button: Displays the source channel of the current destination channel.

Turning the knob: Changes the source channel.

Pressing the control knob applies the change.

* Press TAKE instead of the control knob when applying source changes in TAKE mode.

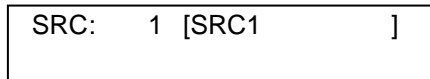

Menu display



Button LCD / Current SRC button (39RUA only)

◆ **Level Mode**

MENU: Displays the current level [name] of the remote control panel.

LCD: Displays the current level and its display on the remote control panel.

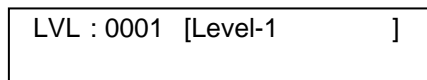

Menu display



Button LCD

◆ **Page Mode**

MENU: Displays the page number currently assigned to the remote control panel.

LCD: Displays the page number currently assigned to the remote control panel.

Turning the knob: Changes the page number.



Menu display



Button LCD

➤ **MODE PAGE (PAGE_Grp-ALL)**

PAGE JUMP	Moves the page to the specified number for all groups.												
PAGE UP/DOWN	Moves the page forward or backward by the specified number for all groups.												
MENU display	<div style="border: 1px solid black; padding: 5px; margin-bottom: 5px;">PAGE (UP/DOWN) Grp-A: 1 B: 1 C: 1 D: 1</div> <div style="border: 1px solid black; padding: 5px;">PAGE (JUMP) Grp-A: 1 B: 1 C: 1 D: 1</div>												
LCD display	<div style="border: 1px solid black; padding: 5px; display: inline-block;">Page Grp-All</div>												
Current PAGE display	<table style="margin-left: 20px;"> <tr><td colspan="2" style="text-align: center;">PAGE</td></tr> <tr><td>A</td><td style="border: 1px solid black; padding: 2px;">01</td></tr> <tr><td>B</td><td style="border: 1px solid black; padding: 2px;">01</td></tr> <tr><td colspan="2"> </td></tr> <tr><td>C</td><td style="border: 1px solid black; padding: 2px;">01</td></tr> <tr><td>D</td><td style="border: 1px solid black; padding: 2px;">01</td></tr> </table>	PAGE		A	01	B	01			C	01	D	01
PAGE													
A	01												
B	01												
C	01												
D	01												

➤ **MODE PAGE (PAGE_Grp-A/B/C/D)**

PAGE JUMP	Moves the page to the specified number for the specified group(s).								
PAGE UP/DOWN	Moves the page forward or backward by the specified number for the specified group(s).								
MENU display	<div style="border: 1px solid black; padding: 5px; margin-bottom: 5px;">PAGE (UP/DOWN) Grp-C: 1</div> <div style="border: 1px solid black; padding: 5px;">PAGE (JUMP) Grp-C: 1</div>								
LCD display	<div style="border: 1px solid black; padding: 5px; text-align: center;">Page 1 Grp-C</div>								
Current PAGE display	<div style="text-align: center;">PAGE</div> <table style="margin-left: auto; margin-right: auto;"> <tr><td>A</td><td style="background-color: black; color: white; text-align: center;">01</td></tr> <tr><td>B</td><td style="background-color: black; color: white; text-align: center;">01</td></tr> </table> <table style="margin-left: auto; margin-right: auto;"> <tr><td>C</td><td style="text-align: center;">01</td></tr> <tr><td>D</td><td style="background-color: black; color: white; text-align: center;">01</td></tr> </table>	A	01	B	01	C	01	D	01
A	01								
B	01								
C	01								
D	01								

◆ **Setting Mode**

➤ In MFR-39RU

Displays available menu settings that can be changed using the control knob.

Turn the control knob to select an item, then change the setting.

The items that can be changed are highlighted.

▶ See Sec. 5-4-3. "Setting Mode Menu (MFR-39RU)"

SETTING>DEF MODE <ENT>

MENU display

MODE
SETTING

Button LCD

5-4-3. Setting Mode Menu (MFR-39RU)

Setting Mode menu items are as shown below.

◆ **Setting Mode menu items**

MENU indication	Description	Reference
SETTING>DEF MODE <ENT>	Allows you to change the remote control panel start-up default mode.	5-4-3-1
SETTING>DEF DEST <ENT>	Allows you to change the remote control panel start-up default destination.	5-4-3-2
SETTING>DEF LEVEL <ENT>	Allows you to change the remote control panel start-up default level.	5-4-3-3
SETTING>PAGE MODE <ENT>	Allows you to select the behavior of the control knob in Page mode.	5-4-3-4
SETTING>PAGEASSIGN <ENT>	Allows you to select a performance feature for the PAGE button assignment.	5-4-3-5
SETTING>DSTINHIBIT <ENT>	Allows you to set the inhibit function to a desired destination.	5-4-3-6
SETTING>SRCINHIBIT <ENT>	Allows you to set the inhibit function to a desired source.	5-4-3-7
SETTING>NAME TYPE <ENT>	Allows you to select a type for the destination, source and level name displays.	5-4-3-8
SETTING>TENKEY MOD <ENT>	Allows you to select how to confirm changes in numeric keypad mode.	5-4-3-9
SETTING>TENKEY NO <ENT>	Allows you to set thresholds of setting ranges in numeric keypad mode.	5-4-3-10
SETTING>SALVO CLR <ENT>	Allows you to clear the button-assigned Salvo.	5-4-3-11
SETTING>BTN ASSIGN <ENT>	Allows you to assign functions to buttons.	5-4-3-12
SETTING>EXIT <ENT>	Exits the Setting Mode menu.	

5-4-3-1. DEF MODE

This menu allows you to select a mode to be displayed on the menu display at start-up of the remote control panel.

```
SETTING>DEF MODE
DESTINATION <ENT>
```

Turn the control knob to select a mode, then press the knob to confirm.

```
DESTINATION : Destination mode
SOURCE      : Source mode
LEVEL       : Level mode
PAGE_Grp-All : Page mode (all groups)
PAGE_Grp-A  : Page mode (Group A)
PAGE_Grp-B  : Page mode (Group B)
PAGE_Grp-C  : Page mode (Group C)
PAGE_Grp-D  : Page mode (Group D)
SETTING     : Control knob setting mode
```

IMPORTANT

Do not turn off the remote control panel until the BUSY indicator, which lights orange, goes off when changing modes. Doing so will disable the change.

5-4-3-2. DEF DEST

This menu allows you to select a destination to be displayed on the menu display at start-up of the remote control panel.

```
SETTING>DEF DEST
DEF DEST: 1<ENT>
```

Turn the control knob to select a destination, then press the knob to confirm the selection.

IMPORTANT

Do not turn off the remote control panel until the BUSY indicator, which lights orange, goes off when changing modes. Doing so will disable the change.

5-4-3-3. DEF LEVEL

This menu allows you to select a level to be displayed on the menu display at start-up of the remote control panel.

```
SETTING>DEF LEVEL
DEF LEVEL:0001<ENT>
```

Turn the control knob to select a level, then press the knob to confirm the selection.

IMPORTANT

Do not turn off the remote control panel until the BUSY indicator, which lights orange, goes off when changing modes. Doing so will disable the change.

5-4-3-4. PAGE MODE

This menu allows you to select the behavior for the control knob in Page mode.

```
SETTING>PAGE MODE
PAGE MODE :JUMP <ENT>
```

Turn the control knob to select a behavior pattern from the below options, then press the knob to confirm the selection.

UP/DOWN: Every turn of the control knob changes the page one page forward or backward.

JUMP : Turn the control knob to display the desired page and press the knob to confirm the display selection.

5-4-3-5. PAGE ASSIGN

This menu allows you to select whether to assign the **PAGE** button to the selected page or all pages by a page button assignment procedure.

```
SETTING>PAGEASSIGN
ASIGN : ONE PAGE <ENT>
```

Turn the control knob to select a performance feature from the below options, then press the knob to confirm the selection.

ONE PAGE: Assigns the **PAGE** button to the selected page.

ALL PAGE: Assigns the **PAGE** button to the button in all pages.

5-4-3-6. DSTINHIBIT

Set INHIBIT to enabled or disabled for a destination channel.

```
SETTING>DSTINHIBIT
DST 1 : OFF <ENT>
```

Turn the control knob to select a destination channel, then press the knob to confirm the selection.

```
SETTING> DSTINHIBIT
DST 1 : ON <ENT>
```

Turn the control knob to select **ON** or **OFF**, then press the knob to confirm the selection. **ON** disables the output selection of the selected destination channel. **OFF** cancels the Inhibit setting.

The indication of buttons assigned to the inhibited destination will be crossed.



5-4-3-7. SRCINHIBIT

Set INHIBIT to enabled or disabled for a source channel.

```
SETTING>SRCINHIBIT
SRC 1 : OFF <ENT>
```

Turn the control knob to select a source channel, then press the knob to confirm the selection.

```
SETTING>SRCINHIBIT
SRC 1 : ON <ENT>
```

Turn the control knob to select **ON** or **OFF**, then press the knob to confirm the selection. **ON** disables the output selection of the selected source channel. **OFF** cancels the Inhibit setting.

The indication of buttons assigned to the inhibited source channel will be crossed.



5-4-3-8. NAME TYPE







This menu allows you to select a name display type for the destination, source and level.

```
SETTING>NAME TYPE
DST BTN :PHY NUM <ENT>
```

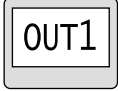
Turn the control knob to select a button group from the destination, source and level buttons. Press the control knob to confirm the selection.

```
SETTING>NAME TYPE
DST BTN :PHY NUM <ENT>
```

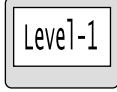
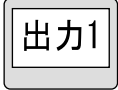
Turn the control knob to select a display type, then press the knob to confirm the selection.

Display type	Description	Example indication		
		DST	SRC	LEVEL
PHY NUM	Physical number display			
ASCII	Ascii character display (Alphanumeric characters and symbols)			
KANJI	2-byte character code including 1-byte character code (Not selectable for LEVEL)			

- * When using 2-byte characters:
 - Up to 8 characters (including one-byte characters) on MFR-39RUA/18RUA/16RUTA units
 - Up to 4 characters (including one-byte characters) on MFR-39RU/18RU units.
- * Up to 14 characters when using only one-byte characters.

5-4-3-9. TENKEY MOD

This menu allows you to change the method to confirm changes in numeric keypad mode.

```
SETTING>TENKEY MOD
INPUT MODE:ENTER <ENT>
```

Turn the control knob to select a method from the below options, then press the knob to confirm the selection.

ENTER : Enter a value and press the **ENTER** button on the displayed numeric keypad on the remote control panel.

DIRECT: Enter a value using the numeric keypad. The value is confirmed.

5-4-3-10. TENKEY NO

This menu allows you to select the start point of each setting between 0 and 1 in numeric keypad mode.

```
SETTING>TENKEY NO
INPUT START NO:0<ENT>
```

Turn the control knob to select **0** or **1**, then press the knob to confirm the selection.

5-4-3-11. SALVO CLR

This menu allows you to clear a specific salvo assigned to a button.

```
SALVO DELETE  
NO: 1<ENT>
```

Turn the control knob to select a salvo to clear, then press the knob to confirm the selection.

If any salvo is assigned, the menu display appears as shown below.

```
SALVO DELETE  
(NO SALVO DATA)
```

5-4-3-12. BTN ASSIGN

This menu allows you to assign button functions.

► See Sec. 5-3 “Function Buttons” for the assignable functions.

```
SETTING>BTN ASSIGN  
BTN NO: 1<ENT>
```

Select a button to change the button assignment by turning and pressing the control knob, or by pressing the desired button.

```
SETTING>BTN ASSIGN  
PAGE: 1<ENT>
```

Select a page to change the button assignment by turning the control knob, then press the knob to confirm the selection.

```
SETTING>BTN ASSIGN  
FUNC:DEST <ENT>
```

Turn the control knob to select a function, then press the knob to confirm the selection. Set details for the function if necessary.

```
SETTING>BTN ASSIGN  
EXEC:NO <ENT>
```

The menu display asks you to confirm the assignment change as shown above when necessary settings are complete. To apply the change to the system, turn and press the control knob to select **Yes**. Selecting **No** cancels the change and returns to the menu display to select buttons.

◆ Setting Function Parameters

Function	Parameter	Note
(NONE)		
DEST	DEST: XXX (XXX: Destination channel number)	
	LEVEL: XXXX (XXXX: Level)	
SRC	SRC: XXXX (XXXX: Source channel number)	
	LEVEL: XXXX (XXXX: Level)	
BUS	DEST: XXX (XXX: Destination channel number)	
	SRC: XXXX (XXXX: Source channel number)	
	LEVEL: XXXX (XXXX: Level)	
PAGE	MODE: JUMP (JUMP: Jump to a specified page /UP : Go forward a page /DOWN: Go back a page)	
	PAGE: XX (XX: Page number)	* Effective for JUMP
	RETPAGE: XX (PREV PAGE: Return to the previous page XX: Jump to the next specified page)	* Effective for JUMP
	GROUP-A: ON (ON / OFF)	
	GROUP-B: ON (ON / OFF)	
	GROUP-C: ON (ON / OFF)	
	GROUP-D: ON (ON / OFF)	
MODE	DESTINATION: ON (ON / OFF)	
	SOURCE: ON (ON / OFF)	
	LEVEL: ON (ON / OFF)	
	PAGE_Grp-All: ON (ON / OFF)	
	PAGE_Grp-A: ON (ON / OFF)	
	PAGE_Grp-B: ON (ON / OFF)	
	PAGE_Grp-C: ON (ON / OFF)	
	PAGE_Grp-D: ON (ON / OFF)	
SETTING: ON (ON / OFF)		
LOCK	LOCK[S]: OTHER (NONE / OTHER / ALL / LOCAL) LOCK function by short press	
	DEST: XX (CURRENT: Locks the current destination. / XX: Destination Channel number to be locked)	* Effective for OTHER and ALL
	LOCK[L]: NONE (NONE / OTHER / ALL / LOCAL) LOCK function by long press	
	DEST: XX (CURRENT: Locks the current destination. / XX: Destination Channel number to be locked)	* Effective for OTHER and ALL
TAKE		
LEVEL	LEVEL: XXXX (XXXX: Level)	
LINK		
TENKEY		
SKIP	MODE: FWD (FWD: Forward / BWD: Backward)	
	COUNT: XXX (XXX: number of channels to skip)	
MON-OUT	OUT: X (X: MONITOR OUT)	* MFR-5000/ 8000 only
O-PREVIEW	DEST: XXX (XXX: Destination channel number)	
SALVO	MODE: MURECALL (MU RECALL: Execute the main unit-assigned SALVO /RU RECALL: Execute the button-assigned SALVO /RU STORE: Assign a SALVO to a button)	
	NO: XXXX (XXXX: Salvo number)	* Effective for MU RECALL, and RU RECALL

5-4-4. Setting Mode Menu (MFR-39RUA)

The current **[SRC]** button functions as an **EXIT/CANCEL** button used for exiting mode or processes during Setting mode.

Use the following procedures to change settings.

- Press a button to turn On/Off.
- Use the control knob to change values.
 - (1) Press to select a desired menu item.
 - (2) Turn the control knob to change its value.
 - (3) Press the control knob to confirm the setting.

After menu setting, do not turn off the remote control unit until the BUSY indicator changes from lit orange to unlit. Otherwise, settings may not be applied.

* To enter Setting mode, press the **[SETUP]** button. The BUSY indicator lights orange during Setting mode. To exit Setting mode, press the **EXIT/CANCEL** button. Before powering off the remote control unit, verify that the BUSY indicator is turned off.

Setting Mode menu items are as shown below.

MENU indication	Description	Reference
NETWORK	Allows you to change the IP address of the remote control unit and display the PC-LAN network information.	5-4-4-1
VER/ALARM	Allows you to display the version and alarm information.	5-4-4-2
DEFAULT	Allows you to change the default settings that are loaded when the remote control unit is powered on.	5-4-4-3
BUTTON ASSIGN	Allows you to assign functions to user-assignable buttons.	5-4-4-4
INHIBIT	Allows you to enable/disable the INHIBIT function for a channel.	5-4-4-5
NAME TYPE	Allows you to select the display type for Destination, Source and Level.	5-4-4-6
BRIGHTNESS	Allows you to set the brightness of buttons.	5-4-4-7
RU-RU CONNECT	Allows you to configure a link system of multiple remote control units.	5-4-4-8
TENKEY	Allows you to set TENKEY (numeric keypad) operation.	5-4-4-9
PAGE	Allows you to change PAGE settings.	5-4-4-10
SALVO CLEAR	Allows you to clear salvo data stored in buttons.	5-4-4-11

5-4-4-1. NETWORK

The following submenus are available in NETWORK setting mode.

Submenu	Description
RU NETWORK	Allows you to change the IP address of the remote control unit and display the network information.
PC-LAN NETWORK	Displays the network settings of the PC-LAN port.
PC-LAN REBOOT	Restarts the PC-LAN port.

NETWORK > RU NETWORK

Menu item	Description
IP	Displays and changes the IP address of the remote control unit. The lower 8 bits (the fourth byte) represent the Unit ID.
MASK	Displays the subnet mask of the remote control unit.
UNIT NAME	Displays the unit name of the remote control unit.

To Change IP Address:

- (1) Hold down the button where the number to be changed is displayed. The button will blink.
- (2) Turn the control knob to change the number.
- (3) Repeat (1) and (2) to change the IP address.
- (4) Hold down the current **DEST** button to confirm the change. The remote control unit will automatically restart.

NETWORK > PC-LAN NETWORK

Menu item	Description
IP	Displays the PC-LAN IP address.
MASK	Displays the PC-LAN subnet mask.
GW	Displays the PC-LAN Default Gateway IP address.

NETWORK > PC-LAN REBOOT

To restart the PC-LAN port:

- (1) Press REBOOT.
- (2) Hold down **EXEC HOLD 1s** to restart the PC-LAN port while showing "STARTUP" or "NOW".

5-4-4-2. VER/ALARM

◆ Menu List

Menu item	Description
VERSION	Displays the firmware version.
PS1	Displays the AC adapter 1 status.
PS2	Displays the AC adapter 2 status.
TEMPERATURE	Displays the temperature.
VOLTAGE	Displays the voltage status.

5-4-4-3. DEFAULT

◆ Menu List

Menu item	Description	Set by
MODE	Allows you to select a mode when the remote control unit is powered on. DEST: Destination mode SRC: Source mode LEVEL: Level mode PAGE ALL: Page mode (all groups) PAGE GROUP A: Page mode (Group A) PAGE GROUP B: Page mode (Group B) PAGE GROUP C: Page mode (Group C) PAGE GROUP D: Page mode (Group D) SETTING: Setting mode	Pressing a button
DEST	Allows you to select a destination channel when the remote control unit is powered on.	CONTROL
LEVEL	Allows you to select a level when the remote control unit is powered on.	Pressing a button

5-4-4-4. BUTTON ASSIGN

This menu displays the assignment list for PAGE 1.

To Assign Functions to Buttons:

- (1) Turn the control knob to select a page.
 - (2) Press a button for assignment. The button will blink and its information will be displayed.
 - (3) Turn the control knob to select a function to the button.
 - (4) Use the control knob to set the corresponding parameter(s). Once the settings are complete, the current **DEST** button blinks and "SAVE" is displayed on the button.
 - (5) Press the current **DEST** button to confirm the settings.
- To perform another assignment, proceed from Step (1).

FUNC Menu List

FUNC	Parameter	Description	Remarks
NONE			
DEST	DESTINATION	Destination channel	
	LEVEL	Level (Available level number are displayed.)	
SRC	SOURCE	Source channel	
	LEVEL	Level (Available level number are displayed.)	
BUS	DESTINATION	channel	
	SOURCE	Source channel	
	LEVEL	Level (Available level number are displayed.)	
PAGE	TYPE	JUMP: Moves to the set page. UP: One page forward DOWN: One page back	
	FORWARD	Page to jump	When TYPE is set to JUMP:
	REVERSE	Page to return HOME: Back to the origin page	
	GROUP	Page group selection	
MODE	TARGET	Mode selection when using the Mode button	
LOCK	TYPE[S]	Lock mode selection for the short-press of the LOCK button.	
	DESTINATION[S]	Destination channel setting for the short-press of destination buttons. CURRENT: Locks the current destination	When ALL or OTHER is set for TYPE[S]:
	TYPE[L]	Lock mode selection for the long-press of the LOCK button.	
	DESTINATION[L]	Destination channel setting for the long-press of destination buttons. CURRENT: Locks the current destination	When ALL or OTHER is set for TYPE[S]:
TAKE			
LEVEL		Level (Available level number are displayed.)	
LINK			
TENKEY			
SKIP	BWD/FWD	Mode selection	
	COUNT	Number to be skipped	

MON-OUT	NO.	Number of monitor output	MFR-5000/8000 only
O-PREV	DESTINATION	Destination channel	
SALVO	TYPE	MU: Execution of an MU salvo. RU: Execution of an RU button salvo STORE: Registration of an MU salvo	
	NO.	Salvo number	When TYPE is set to MU or RU:

5-4-4-5. INHIBIT

The following submenus are available in INHIBIT Setting mode.

Submenu	Description
DEST	Allows you to set INHIBIT to enabled / disabled for a destination channel. Symbol "X" appears on channels when INHIBIT is enabled.
SRC	Allows you to set INHIBIT to enabled / disabled for a source channel. Symbol "X" appears on channels when INHIBIT is enabled.

INHIBIT > DEST

Displays the destination channel list. Press a channel to enable/disable the INHIBIT function.

INHIBIT > SRC

Displays the source channel list. Press a channel to enable/disable the INHIBIT function.

5-4-4-6. NAME TYPE

Menu List

Menu Item	Description	Set by
DEST	Allows you to select the display format for a destination button.	Pressing a button
SRC	Allows you to select a display format for a source button.	Pressing a button
LEVEL	Allows you to select the display format for a level button.	Pressing a button

Available formats are as shown in the table below.

Display format	Description	Display example		
		DST	SRC	LEVEL
PHY NUM	Physical number display	OUT1	IN1	LV0001
ASCII	Ascii character display (Alphanumeric characters and symbols)	MV_IN1	VTR1	Level-1
KANJI	2-byte character code including 1-byte character code (Not selectable for LEVEL)	出力1	素材1	

* When using 2-byte characters:

Up to 8 characters (including one-byte characters) on MFR-39RUA/18RUA/16RUTA units

Up to 4 characters (including one-byte characters) on MFR-39RU/18RU units

* Up 14 characters when using only one-byte characters

5-4-4-7. BRIGHTNESS

Menu List

Menu item	Description	Set by
BUTTON	Allows you to select a button.	Pressing a button
LOW LIGHT	Allows you to select between NORMAL and LOWLIGHT for dim lighting.	Pressing a button

5-4-4-8. RU-RU CONNECT

Menu List

Menu item	Description	Set by
CONNECT	Allows you to enable /disable the link of remote control units.	Pressing a button
MASTER ID	Allows you to select a link ID.	CONTROL

5-4-4-9. TENKEY

Menu List

Menu item	Description	Set by
INPUT MODE	Allows you to select the confirmation method when using the numeric keypad. DIRECT: Confirms setting by just pressing a numeric key. ENTER: Confirms setting by pressing a numeric key then pressing ENTER.	Pressing a button
START	This menu allows you to select the start point of each setting between 0 and 1 in numeric keypad mode.	Pressing a button

5-4-4-10. PAGE

Menu List

Menu item	Description	Set by
MODE	Allows you to select the control knob behavior in Page mode. UP/DOWN: Turns the control knob to move one page forward/back. JUMP: Turns the control knob to select a page then presses the control knob to move to the page.	Pressing a button
ASSIGN	Allows you to select ONE PAGE or ALL PAGE for PAGE button assignments.	Pressing a button
DISPLAY	Allows you to select whether to display unit names for Current PAGE display (C/D). PAGE C&D: Current PAGE display for Group C and D. UNIT NAME: Displays unit names.	Pressing a button

5-4-4-11. SALVO CLEAR

This menu displays the button-assigned salvo list and allows you to clear salvos.

To Clear a Button-assigned Salvo:

- (1) Press a salvo button. The button will blink and "CLEAR" is displayed on the button.
- (2) Press the current **DEST** button.

5-5. Operation Using the Menu Display (MFR-16RUD)

The MFR-16RUD, a remote control unit with a display, allows you to select destination channels and switch crosspoints using the menu display. Function button assignments are also possible.

◆ Default Display

The name of Current Destination Channel is displayed on the first line.

The name of Source Channel selected for Current Destination is displayed on the second line.

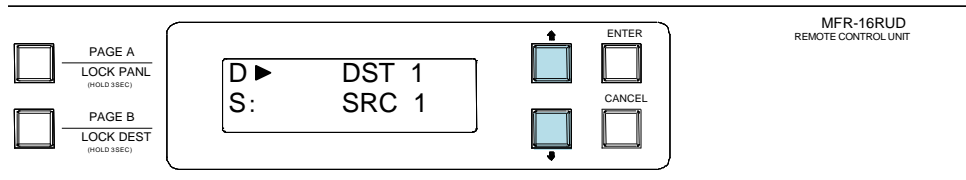

5-5-1. Crosspoint Switching

To switch crosspoints on the MFR-16RUD, proceed as follows:

- (1) Press the **UP** or **DOWN** button to change Current Destination to the desired number. (DST 5 in this example)

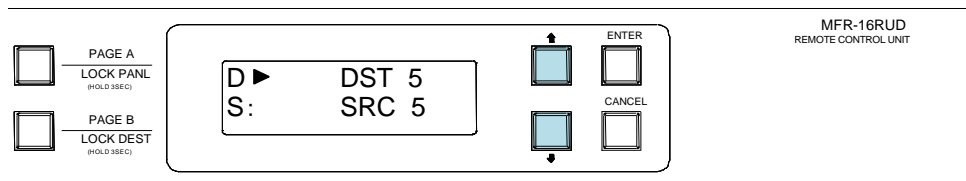

- (2) Press **ENTER**.

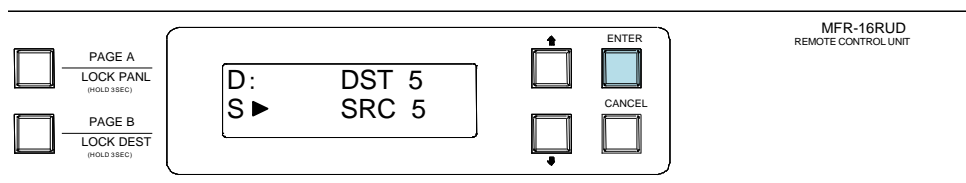

The cursor automatically moves to the second line (Source side). Press **UP** or **DOWN** to select a source channel.

Note that source names blink during the selection.

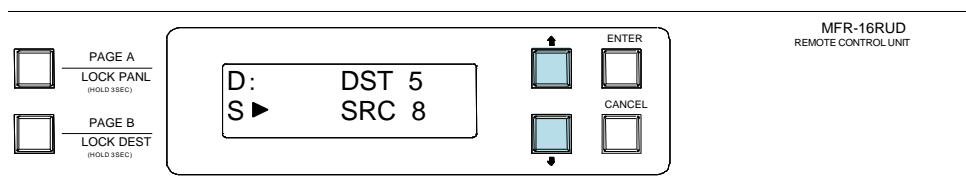

- (3) Press **ENTER** to perform the crosspoint switch. The screen will return to the default display.

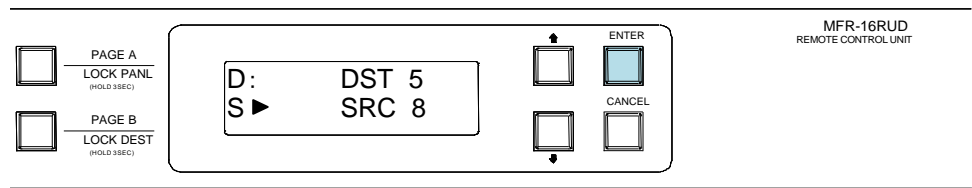

5-5-2. Button Assignment Change

To change button assignments, proceed as follows:

- (1) Press a button while holding down **ENTER**. The button will blink.

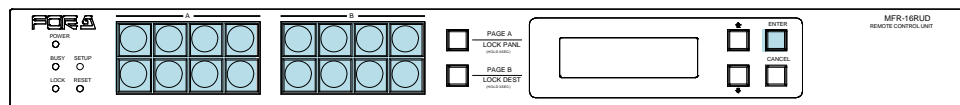

The first line will display the function and its parameter currently assigned to the button and the second line will display its detailed information.

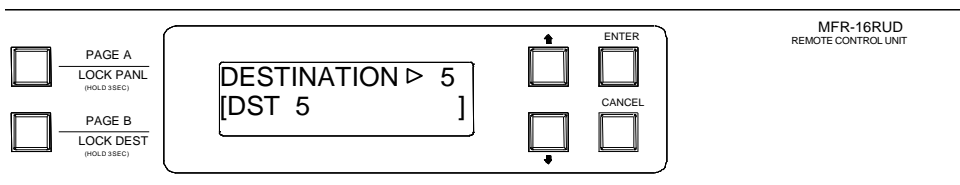

- (2) Press **UP** or **DOWN** to select a function to be assigned. Press **ENTER** to apply the change.

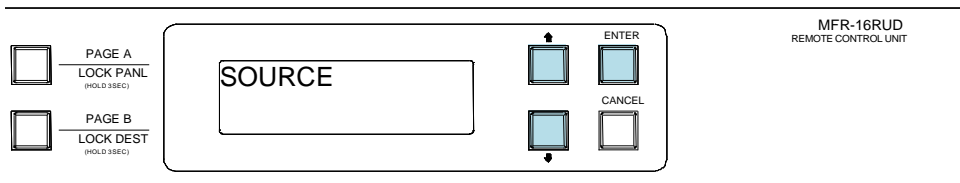

- (3) The display changes to the parameter selection according to the selected function. Press **UP** or **DOWN** to select the parameter value. Press **ENTER** to confirm the selection. The cursor will move to the next parameter if there are two or more parameters. Set the value and press **ENTER** in the same way. Note that parameters blink during the selection.

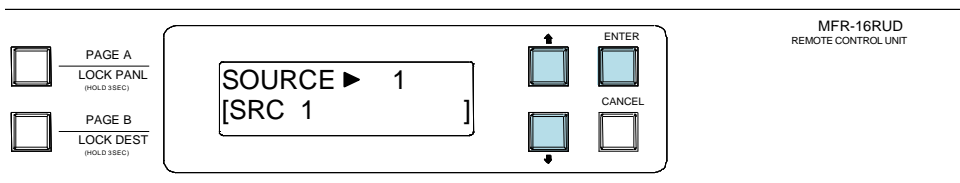

When all settings are finished, the screen automatically returns to its default display.

◆ Assignable Function/Parameter List

Function	Parameter	Description
(NONE)	None	
DESTINATION	DESTINATION ► XXX	XXX: Destination Channel number
SOURCE	SOURCE ► YYYY	YYYY: Source Channel number
BUS	BUS D ► XXX ▷ S YYYY	XXX: Destination Channel number YYYY: Source Channel number
LOCK	(Lock function by short press) LOCK ^S ► XXX ▷ YYY (Lock function by long press) LOCK ^L ► XXX ▷ YYY	XXX: OTH LOCK OTHER ALL LOCK ALL LOC LOCK LOCAL NON No lock YYY: CUR Current Destination Destination Channel number YYY is effective only when XXX is set to OTHER or ALL.
TAKE	None	
LINK	None	
MON-OUT	MON-OUT ► X	X: MONITOR OUT number * MFR-5000/8000 only
PREVIEW	PREVIEW ► XXX	XXX: Destination Channel number
SALVO	SALVO ► XX ▷ YYYY	XX : MU Main unit stored salvo RU Remote control panel button assigned salvo YYYY: Salvo number

5-6. Setup Menu (MFR-39RU)

The SETUP button enables you to use the setup menu. The Setup menu has the following sub menus. To select a submenu, turn the control knob to select and press to confirm.

◆ Setup Menu Sub-menu List

Menu display	Description	Reference
SETUP>IP ADDRESS[RU] <ENT>	Allows you to set the IP address for the remote control panel. The last 8bits will be the unit ID.	5-6-1
SETUP>SUBNET MASK[RU] <ENT>	Displays the subnet mask setting in the Remote Control Unit.	5-6-2
SETUP>PC-LAN[MU]<ENT>	Displays the PC-LAN[MU] menu.	5-6-3
SETUP>RU CONN ID <ENT>	Allows you to set the ID to recognize remote control panels connected to be used in conjunction.	5-6-4
SETUP>RU CONNECT <ENT>	Allows you to select whether to connect and use multiple remote control panels.	5-6-5
SETUP>BRIGHTNESS <ENT>	Allows you to set the brightness for buttons and the menu display.	5-6-6
SETUP>BTN ASSIGN <ENT>	Allows you to assign functions to buttons. Assignments the same as in the Setting mode menu can be performed.	5-6-7
SETUP>VER/ALARM <ENT>	Displays version and alarm information.	5-6-8
SETUP>REBOOT <ENT>	Allows you to reboot the unit.	5-6-9
SETUP>EXIT <ENT>	Allows you to exit the Setup menu. The menu returns to display the menu before entering the SETUP menu. (The CANCEL button works the same.)	

5-6-1. IP ADDRESS[RU]

This menu allows you to change the IP address of remote control panels. The last 8 bits (the 4th byte) will be the unit ID.

```
SETUP>IP ADDRESS[RU]
192.168.001.100<ENT>
```

Turn the control knob to select a byte to be changed. The selected byte will be highlighted. After changing the value, press the knob. The next byte to be changed will be highlighted.

```
SETUP>IP ADDRESS
192.168.001.100<ENT>
```

Pressing the control knob while the 4th byte is highlighted will highlight the whole IP address, and the changed IP address will be saved. Press the control knob again. The remote control panel will restart, or a message appears to ask to restart the remote control panel. Select YES and press the control knob to restart the remote control panel with the new IP address.

IMPORTANT

The saved IP address is applied when the remote control panel restarts. Selecting NO will necessitate a manual restart of the remote control panel to apply the new IP address. The IP address must not be identical to the IP address of the MFR main unit or other remote control panels.

5-6-2. SUBNET MASK[RU]

Displays the subnet mask setting in the Remote Control Unit.

```
SETUP>SUBNET MASK[RU]
255.255.255.000
```

5-6-3. PC-LAN[MU]

The PC-LAN[MU] menu allows you to display the network settings for the PC-LAN port on the MU and restart the port.

```
SETUP>PC-LAN[MU]>
NET <ENT>
```

Selecting NET allows you to display the network port settings.

Turning the control knob allows you to scroll through all network settings.

```
PC-LAN[MU]>IP ADDRESS
192.168.001.012 <ENT>
```

```
PC-LAN[MU]>SUBNET MASK
255.255.255.000 <ENT>
```

```
PC-LAN[MU]>GATEWAY
000.000.000.000 <ENT>
```

Selecting GUI REBOOT allows you to restart the network port.

```
SETUP>PC-LAN[MU]
GUI REBOOT<ENT>
```

```
PC-LAN[MU]>GUI REBOOT
EXEC: NO <ENT>
```

To restart the port, turn the control knob to select **YES**, then press the control knob.

To cancel the process, turn the control knob to select **NO**. The display will return to the initial SETUP menu page.

The following message will appear while the port is being restarted.

```
PC-LAN[MU]>GUI REBOOT
Startup...
```

5-6-4. RU CONN ID

This menu allows you to set the ID for remote control panel IDs to be recognized in the integrated use of multiple remote control panels.

```
SETUP>RU CONN ID
UNIT ID: 0<ENT>
```

Turn the control knob to select an ID, then press the knob to confirm the selection. See Sec. 5-11-2 "Enabling Multi-Panel Operation"

IMPORTANT

Do not turn the power of the remote control panel off before the orange BUSY lamp goes off when changing ID. Doing so will obstruct the settings to be applied.

5-6-5. RU CONNECT

This menu allows you to enable or disable integrated operation of connected multiple remote control panels.

```
SETUP>RU CONNECT
ENABLE:OFF<ENT>
```

Turn the control knob to select **ON** or **OFF**, then press the knob to confirm the selection.

IMPORTANT

Do not turn the power of the remote control panel off before the orange BUSY lamp goes off when changing ID. Doing so will obstruct the settings to be applied.

5-6-6. BRIGHTNESS

This menu allows you to set the brightness for the button LCDs and menu display.

```
SETUP>BRIGHTNESS
BTN:8 MENU:8<ENT>
```

Turn the control knob to select the brightness. Press the control knob to change the BTN and MENU selection. Pressing the control when MENU is selected confirms the changes. After settings are complete, press the CANCEL button to exit the menu.

Brightness: (dark) **1** to **8** (bright)

5-6-7. BTN ASSIGN

This menu allows you to assign functions to buttons. The functions that are the same as those assignable in the Setting mode BTN ASSIGN menu can be assigned.

- ▶ See Sec. 5-4-3-12 "BTN ASSIGN" for the setting procedure.

```
SETUP>BTN ASSIGN
BTN NO: 1<ENT>
```

5-6-8. VER/ALARM

This menu displays the version and alarm information. Turn the control knob to scroll the page.

```
Ver.0.05.1
PS1: Normal
```

5-6-9. REBOOT

This menu allows you to execute a restart of the remote control panel.

```
SETUP>REBOOT
EXEC:NO<ENT>
```

Turn the control knob to select **YES** or **NO**, then press the knob to confirm the selection. Selecting YES will restart the remote control panel. Pressing NO will return you to the menu display to select menus.

5-7. Setup Menu (MFR-39RUA)

The **SETUP** button allows you to enter **Setup Menu** mode, in which menu settings can be performed as shown in Sec 5-4-4. "Setting Mode Menu (MFR-39RUA)."

5-8. Setup Menu (MFR-18RU/18RUA)

The **SETUP** button allows you to enter **Setup Menu** mode, in which RU and MU PC-LAN network settings are displayed, the MU-PC LAN port can be rebooted, and RU network settings can be changed. The left three buttons are used to select information to be displayed or the PC-LAN reboot. To exit Setup Menu mode, press the **SETUP** button again.

Selection buttons (See the figures below)	LAN Port	Display / Execution
Button A	Remote Control Unit (RU)	IP address display and change Subnet mask display
Button B	PC-LAN on Main Unit (MU)	IP address display Subnet mask display Default gateway display
Button C	PC-LAN on Main Unit (MU)	Reboot

5-8-1. Displaying Network Settings

◆ To Display RU IP Address and Subnet Mask

Press **SETUP** to enter Setup Menu mode. The RU IP address and subnet mask are displayed as shown below. (If Button A is off (unlit), press Button A.)

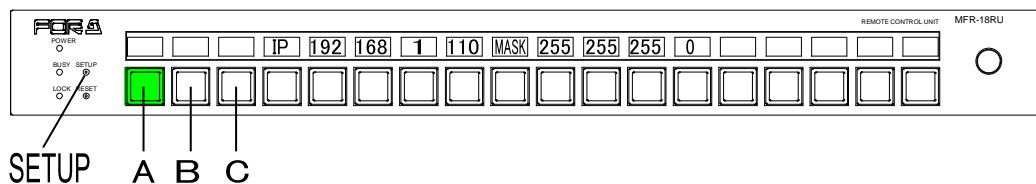

◆ To Display IP address, Subnet Mask and Default Gateway of MU PC-LAN

Press Button **B** in Setup Menu mode. The network settings are displayed as shown below, in order, as "IP address, Subnet Mask and Default Gateway."

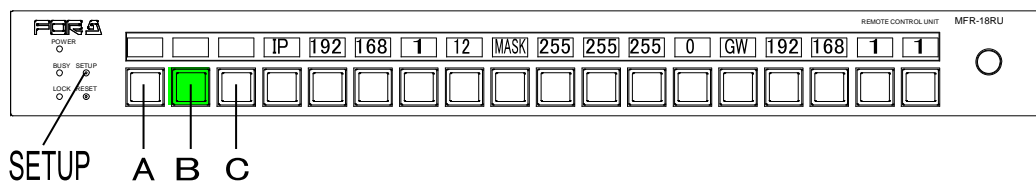

5-8-2. Changing the RU Network Settings

(1) Press **SETUP** to enter Setup Menu mode. The RU IP address and subnet mask are displayed as shown below. (If Button A is off (unlit), press Button A.)

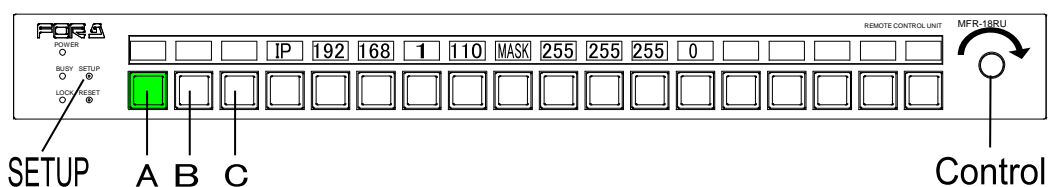

- (2) Press and hold down a button below the number for change. The number will blink.
- (3) Turn the control knob to change the number value. To clear the number setting, press and hold down the button.
- (4) Repeat steps (2) and (3) to change the IP address.
- (5) When a number is changed, the **SAVE** button will blink. Press and hold down **SAVE** to confirm the change. The Remote Control Unit will automatically restart.
To cancel the process, display another information without pressing **SAVE**.

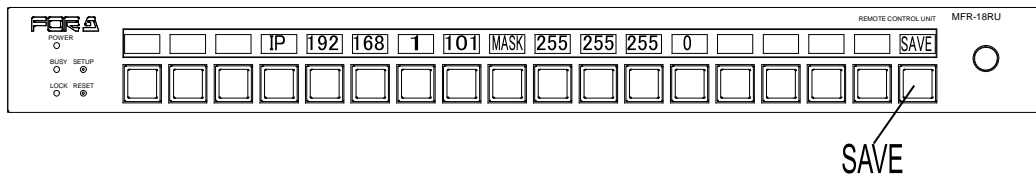

5-8-3. Rebooting MU PC-LAN

- (1) Press Button **C** in Setup Menu mode.
- (2) Press and hold down the **REBOOT** button shown below. The **EXEC** button will appear.
- (3) Press and hold down **EXEC**. The "PC-LAN Startup" message is displayed during rebooting. The message will disappear when the reboot is complete.

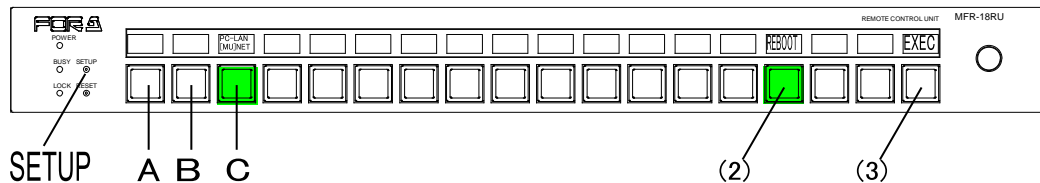

5-9. Setup Menu (MFR-16RUTA)

The **SETUP** button allows you to enter **Setup Menu** mode, in which RU and MU PC-LAN network settings are displayed, the MU PC-LAN port can be rebooted, and RU network settings can be changed. The left three buttons are used to select information to be displayed or the PC-LAN reboot. The fourth button from the left is used to switch network information display. To exit Setup Menu mode, press the **SETUP** button again.

Selection buttons (See the figures below)	LAN Port	Display / Execution
Button A	Remote Control Unit (RU)	IP address display and change Subnet mask display
Button B	PC-LAN on Main Unit (MU)	IP address display Subnet mask display Default gateway display
Button C	PC-LAN on Main Unit (MU)	Reboot
Button D	If Button A or B is selected	Display item change

5-9-1. Displaying Network Settings

◆ To Display RU IP Address and Subnet Mask

Press **SETUP** to enter Setup Menu mode. (If Button **A** is off (unlit), press Button **A**.)
Pressing Button **D** displays the RU IP address and repressing it displays the subnet mask.

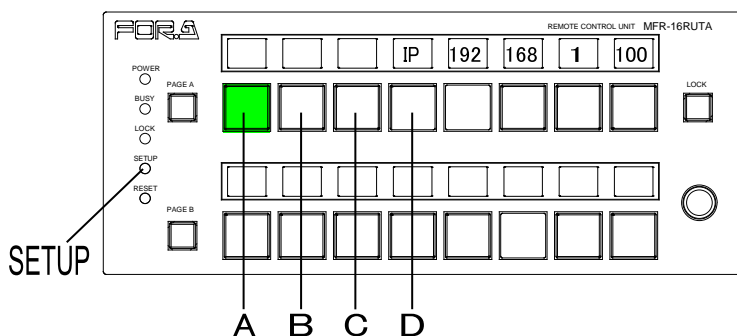

◆ To Display IP address, Subnet Mask and Default Gateway of MU PC-LAN

Press Button **B** in Setup Menu mode. The IP address, subnet mask and default gateway are successively displayed by pressing Button **D**.

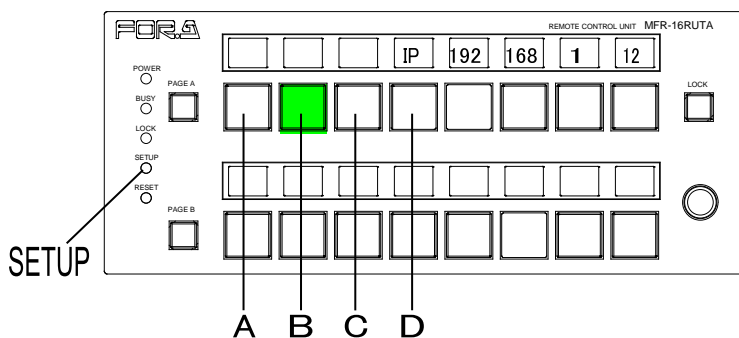

5-9-2. Changing the RU Network Settings

- (1) Press **SETUP** to enter Setup Menu mode. (Press Button **A** if other information is displayed.)

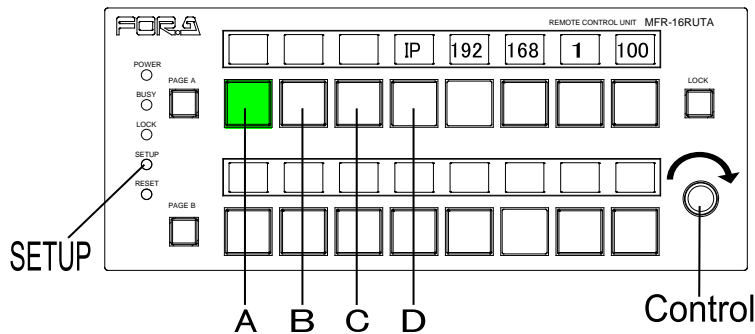

- (2) Press and hold down a button below the number for change. The number will blink.
- (3) Turn the control knob to change the number value. To clear the number setting, press and hold down the button.
- (4) Repeat steps (2) and (3) to change the IP address.
- (5) When a number is changed, the **SAVE** button will blink. Press and hold down **SAVE** to confirm the change. The Remote Control Unit will automatically restart. To cancel the process, display another information without pressing **SAVE**.

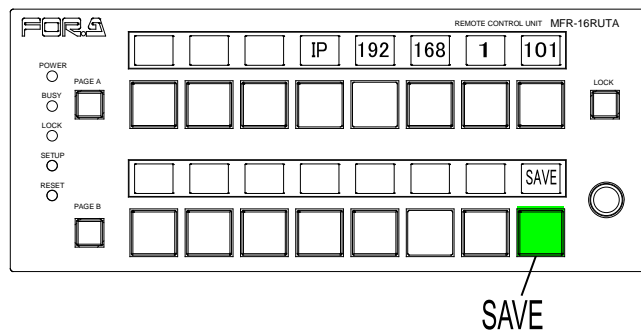

5-9-3. Rebooting MU PC-LAN

- (1) Press Button **C** in Setup Menu mode.
- (2) Press and hold down the **REBOOT** button shown below. The **EXEC** button will appear.
- (3) Press and hold down **EXEC**. The "PC-LAN Startup" message is displayed during rebooting. The message will disappear when the reboot is complete.

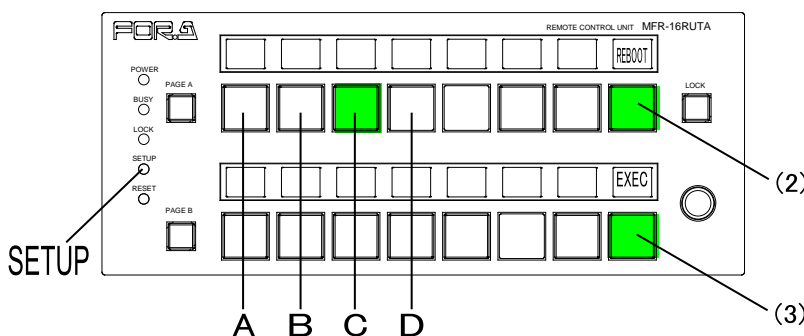

5-10. Setup Menu (Other Remote Control Units)

The **SETUP** button changes the RU to **Setup Menu** mode, which allows you to display RU and MU PC-LAN network settings, reboot the MU PC-LAN port, and change the RU network settings

To exit Setup Menu mode, press the **SETUP** button again.

◆ IP Address Display

The following procedure shows how to display an IP address in Setup Menu mode using MFR-16RU as an example.

(1) Press **SETUP**. All indicators, POWER, BUSY and LOCK, turn on orange to indicate that the RU enters in Setup Menu mode.

(2) Press Button **D**. (If Button **B** or **C** is lit, press the lit button.)

(3) Press the left-most button (the first octet) of Buttons **H**.

The first octet number will be displayed on Buttons **I**. If the MFR-16RU IP address is set to "192.168.1.100," The eight buttons (8 bits) displays "192" (128+64) by turning the light **On** or **Off** for each bit (On, On, Off, Off, Off, Off, Off, Off).

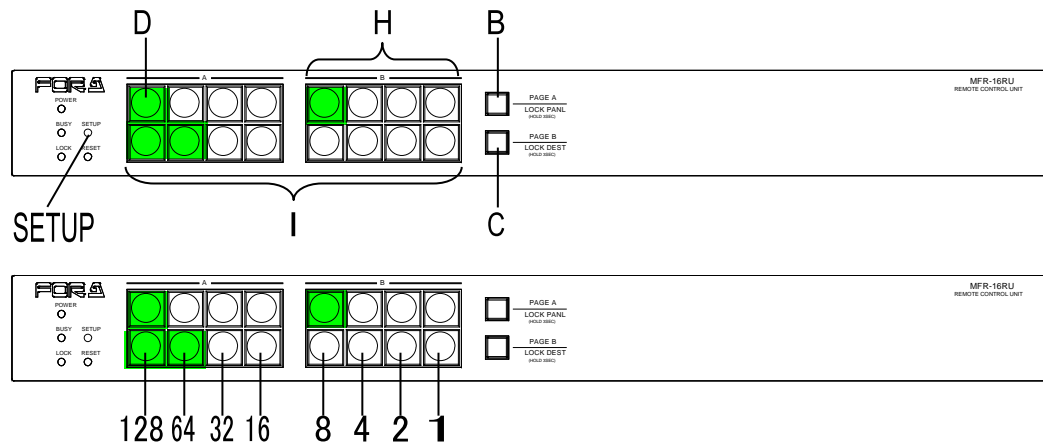

(4) Press the second button (the second octet) of Buttons **H**.

The number value will be displayed on Buttons **I**.

If the MFR-16RU IP address is set to "192.168.1.100," "168" will be displayed.

(5) Press the third button (the third octet) of Buttons **H**.

The number value will be displayed on Buttons **I**.

If the MFR-16RU IP address is set to "192.168.1.100," "1" will be displayed.

(6) Press the right-most button (the fourth octet) of Buttons **H**.

The number value will be displayed on Buttons **I**.

If the MFR-16RU IP address is set to "192.168.1.100," "100" (64+32+4) will be displayed as shown below (Off, On, On, Off, Off, On, Off, Off).

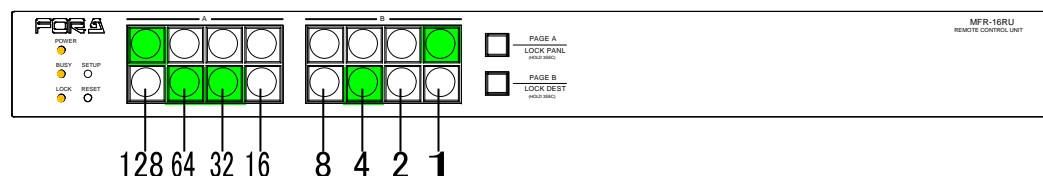

5-10-1. Displaying Network Settings

(1) In Setup Menu mode, press a button shown in the table below to display the desired network setting. Note that button locations vary depending on remote control units.

Button operation		LAN port	Display Info.
Press D.	If B is lit, press B. If C is lit, press C.	Remote Control Unit (LAN)	IP address
Press E.	If B is lit, press B. If C is lit, press C.		Subnet mask
Press B, then D.		PC-LAN on Main Unit (MU)	IP address
Press B, then E.			Subnet mask
Press B, then F.			Default Gateway

(2) Press an octet button of Buttons **H** to select an octet. The right-most button represents the fourth octet. (See the previous page.)

(3) The octet value will be displayed on Buttons **I** (eight buttons). (See the previous page.)

MFR-40RU

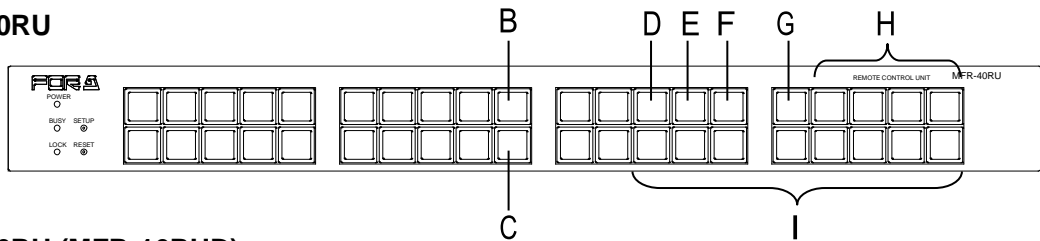

MFR-16RU (MFR-16RUD)

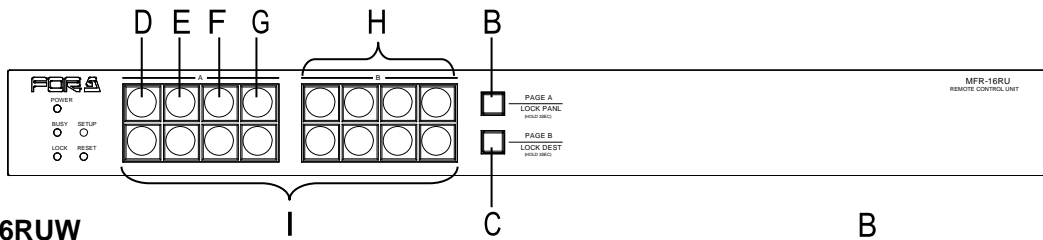

MFR-16RUW

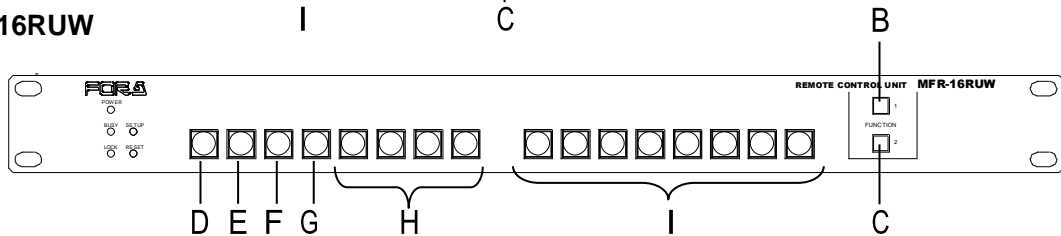

MFR-32RUW

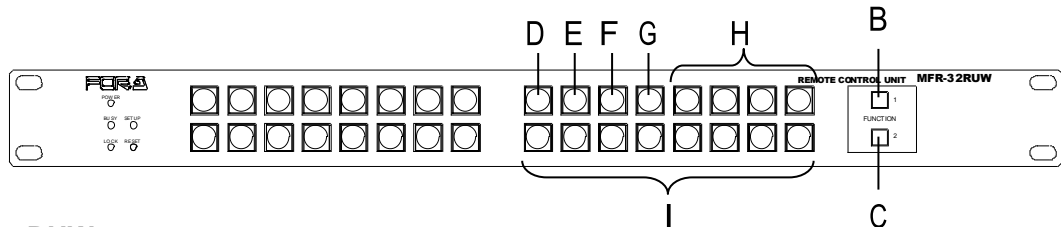

MFR-64RUW

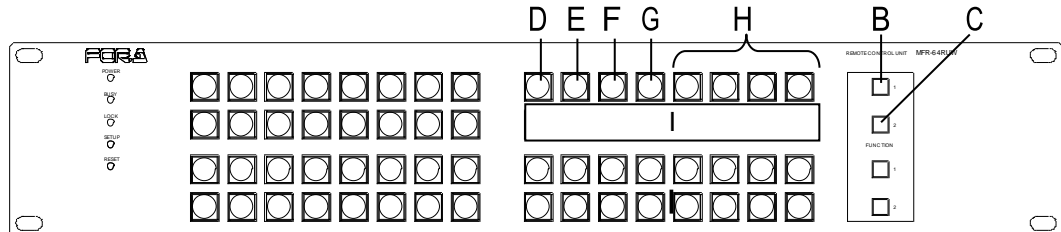

5-10-2. Changing the RU IP Address

The RU IP address can be changed as shown in the procedure below, which changes the MFR-16RU IP address from "192.168.1.100" to "192.168.1.101."

Button locations vary depending on remote control units. Refer to the previous page for other remote control unit button locations.

- (1) Press Button **D** in **Setup Menu** mode. (If Button **B** or **C** is lit, press the lit button.)
- (2) Press and **hold down** the **right-most** button (the fourth octet) of Buttons **H**. The button will blink and the bottom eight buttons (Buttons **I**) display the value (100) by turning the light **On** and **Off**.

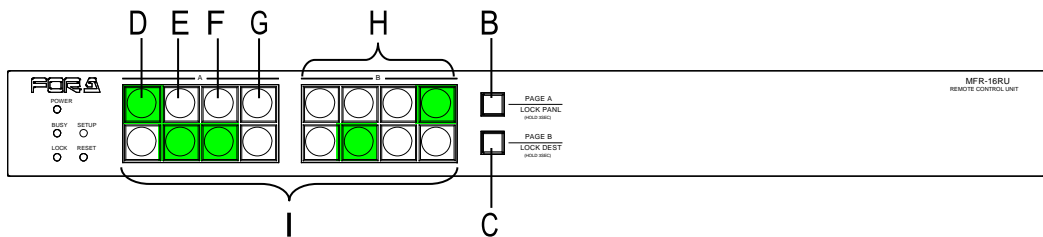

- (3) On the bottom row, press the **right-most** button of Buttons **I** to turn on the button. The octet value will change to "101" ($64+32+4+1$).

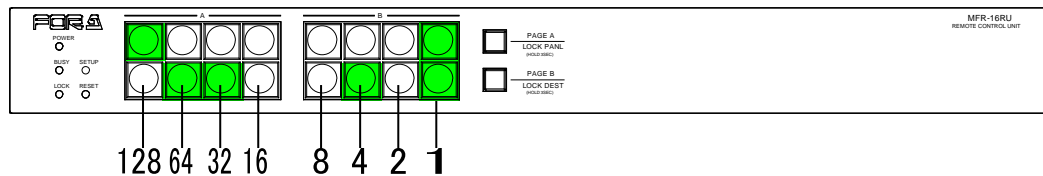

To change the first, second or third octet value, repeat steps (2) and (3), respectively. To clear an octet value, press the flashing octet selection button on the upper row.

- (4) When a value is changed, Button **G** will blink. Press and hold down G to confirm the change. The Remote Control Unit will automatically restart. To cancel the process, press Button **B** or **C** without pressing **G**.

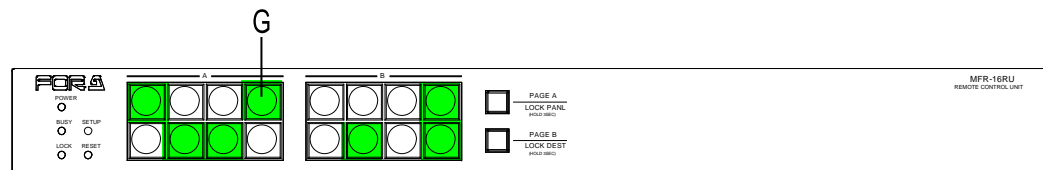

5-10-3. Rebooting MU PC-LAN

- (1) Press Button **C** in Setup Menu mode.
- (2) Press and hold down Button **K**. Button **L** (EXEC button) will blink.
- (3) Press and hold down Button **L**. Buttons **I** will blink during rebooting. The buttons will turn off when the reboot is complete.

MFR-40RU

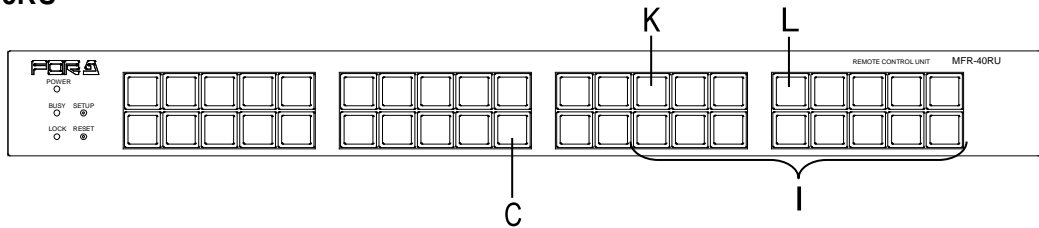

MFR-16RU (MFR-16RUD)

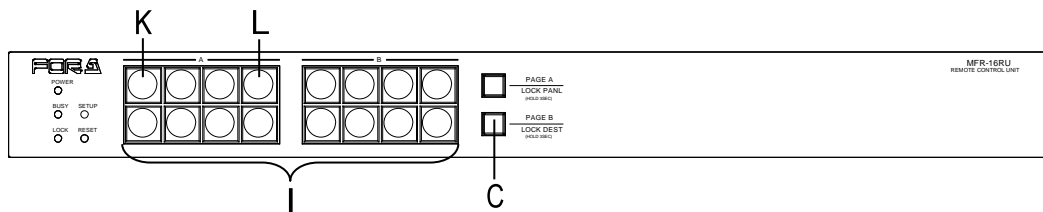

MFR-16RUW

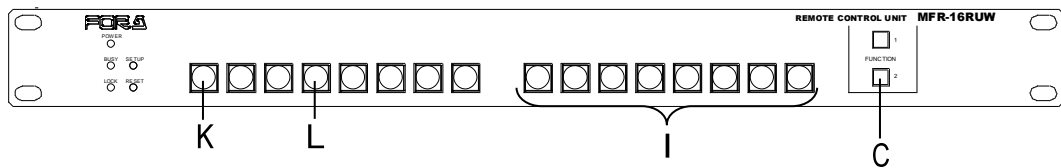

MFR-32RUW

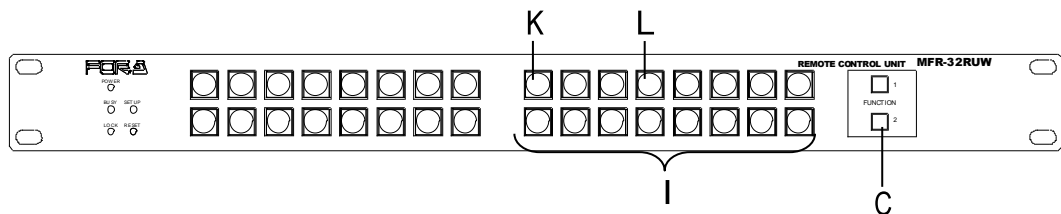

MFR-64RUW

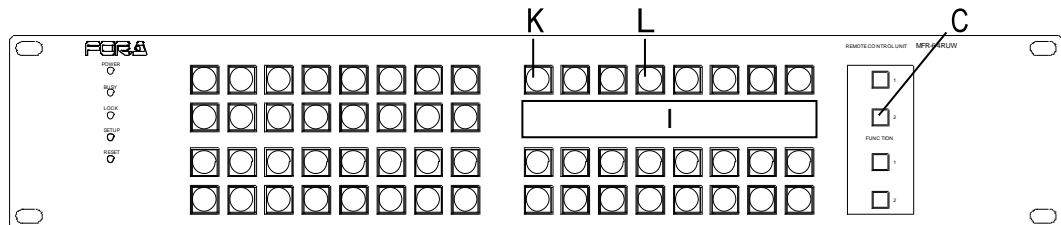

5-11. Multi-Panel Operation

5-11-1. Outline

Multiple remote control panels can be connected to build a large control panel.

(Ex.) To build a 96 x 96 maximum control system:

Units to use: MFR-40RU x 4, and MFR-39RU x 1

Configuration:

Destination button assignments to: MFR-40RU x 2 and a part of MFR-39RU

Source button assignments to: MFR-40RU x 2 and a part of MFR-39RU

This system can control 96 x 96 inputs and outputs without using the PAGE function.

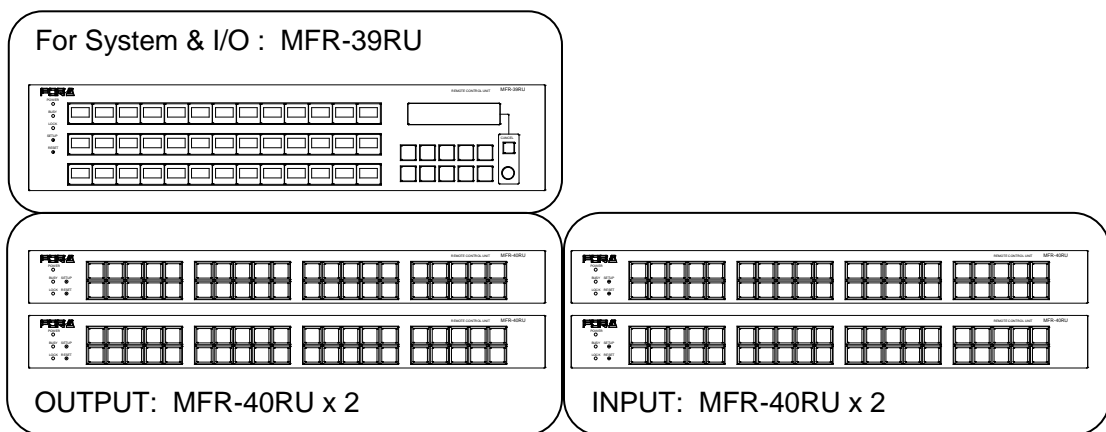

◆ Functions that can be integrated

The following operation can be integrated between the connected remote control panels by the interlock function.

- To select destination channels
- To select mode menus by the **MODE** button, and to select destination/source channels and levels by the control knob.
- To enable or disable Lock functions (LOCK LOCAL, LOCK OTHER, and LOCK ALL)

● Lock functions in the multi-panel operation

All connected remote control panels work as one remote control panel, so:

- LOCK LOCAL:** All integrated remote control panels are locked locally.
- LOCK OTHER:** Restricts units other than the remote control panels in the multi-panel operation system from changing crosspoints.
All integrated remote control panels can unlock the Lock function.
- LOCK ALL:** Restricts all units within the multi-panel operation system from changing crosspoints.
All integrated remote control panels can unlock the Lock function.

5-11-2. Enabling Multi-Panel Operation

Multi-panel operation can be enabled in the Setup menu or in the [Web-based Control: **RU Settings** page].

The procedure to enable multi-panel operation in the Setup menu is as shown below. (Supported only by MFR-39RU/39RUA)

◆ MFR-39RUA

Step	Description	Refer to
1	Press SETUP to enter Setup menu.	
2	Press RU-RU CONNECT .	
3	Change CONNECT to ENABLE .	5-4-4-8
4	Turn the control knob to select a link ID under MASTER ID . * The link ID is used to configure a link of multiple remote control units and equal to the unit ID of the master unit in the remote control unit link. To configure the remote control unit link using the master unit of Unit ID 100, set MASTER ID to 100 for another remote control unit in the link system.	5-4-4-8
5	To exit Setup Menu mode, press EXIT twice.	

◆ MFR-39RU

Step	Description
1	Press the SETUP button to open the Setup menu.
2	Turn the control knob to select RU CONN ID , and press the knob to confirm. <div style="border: 1px solid black; padding: 5px; width: fit-content; margin: 0 auto;"> SETUP>RU CONN ID UNIT ID: 0<ENT> </div> <p style="text-align: center;">Menu display</p>
3	Turn the control knob to select the ID, and press the knob to confirm. ID: This ID is used to synchronize remote control panels for multi-panel operation. All panels must have the same ID as the unit ID of the master remote control panel of the system. (ex.) To enable multi-panel operation using a master remote control panel whose unit ID is 100, set the ID as 100 for all integrated remote control panels.
4	Press the CANCEL button to return the menu display to select menus. Turn the control knob to select RU CONNECT , and press the knob to confirm. <div style="border: 1px solid black; padding: 5px; width: fit-content; margin: 0 auto;"> SETUP>RU CONNECT ENABLE:OFF<ENT> </div> <p style="text-align: center;">Menu display</p>
5	Turn the control knob to select ON , and press the knob to confirm.

Perform the above procedure for each remote control panel to be integrated.

To enable multi-panel operation in Web-based Control, proceed as follows:

- (1) Click the remote control unit for setting to display the menu tree. Select **RU Settings** to display the menu.
- (2) Set the master remote control unit using Unit ID under **Master ID** (for RU Linkage).
- (3) Set **RU Linkage** to **ON**.

6. Crosspoint Control

6-1. One Crosspoint Switching

There are two ways of switching crosspoints: Switching a crosspoint one at a time, or switching multiple crosspoints simultaneously. This section describes the switching of one crosspoint.

6-1-1. One Crosspoint Switching by X-Y Setting

A crosspoint can be switched by using the destination and source buttons on the remote control panel.

Destination and source channels must be assigned to those buttons beforehand.

(Ex.) The procedure to output source channel 8 to destination channel 4.

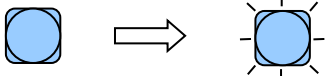
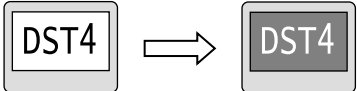
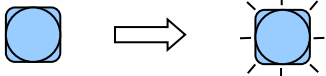
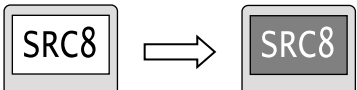
Step	Description	Indications
1	Press a destination button to select destination channel 4.	<p>- The selected destination button lights up.</p>  <p>- The button with the destination channel indication will be highlighted.</p>  <p>- Menu display appears as shown below.</p> <pre> DST : 4 [DST4] LVL : 0001 [Level-1] </pre>
2	Press a source button to select source channel 8.	<p>- The selected source button lights up.</p>  <p>- The button with the source channel indication will be highlighted.</p> 

- Destination and source channels can also be selected by the control knob or using the display. To select channels by the control knob, the mode menu must be set to destination mode or source mode using the **[MODE]** button(s). (Supported for MFR-39RU/39RUA/18RUA/18RU/16RUTA)

Operation using the display is available only on MFR-16RUD.
- MFR-18RU/16RUTA/18RUA units have the Control DestMode function, which can be set in the [Web-based Control: **RU Settings** page]. If **Control DestMode** is set to **Crosspoint**, crosspoints can be switched by turning **[CONTROL]** after pressing a destination button with CONTROL pressed.

 - ▶ See Sec. 5-2-3 "Control Knob" for details.
- Control Assist Buttons

The following functionalities can be assigned to remote control panel buttons to assist crosspoint switches.

 - ▶ See Sec. 6-1-1-1 "SKIP-FWD/SKIP BWD" for SKIP-FWD and SKIP-BWD
 - ▶ See Sec. 6-1-1-2 "TENKEY" for -TENKEY

6-1-1-1. SKIP-FWD/BWD

The **SKIP-FWD** button allows you to skip the set destination number or source channels forward to select the current one. The **SKIP-BWD** button allows you to skip channels backward.

In Destination or Source mode, the set number of channels is skipped. In Level, Page or Setting mode, these buttons are inoperable. (See Sec. 5-4-2. "Mode Menu.")

* To confirm the source selection, press the control knob.

If the source and/or destination channels are categorized, the buttons allows you to go to the first or last channel in the category.

(Ex.) If Category 1: Dest 1 to 13, Category 2: Dest 14 to 20,
SKIP-FWD is set to 5, and
Current destination is 1.

Pressing the **SKIP-FWD** button selects destination channels 1 → 6 → 11 → 13 → 14 → 19 → 20 → 21 → 26 → 31 → and so on.

The categories are user programmable source or destination channel groups. They are set under **Category** accessed from each Web-based Control page.

[Web-based Control: **Router System Settings > Source Name > Category**]

[Web-based Control: **Router System Settings > Destination Name > Category**]

► See Sec. 5-4-3-12. "BTN ASSIGN" for details on how to assign these buttons.

6-1-1-2. TENKEY (MFR-39RU/39RUA)

The **TENKEY** button is used to enable Tenkey mode. Tenkey mode allows you to select source and destination channels using the numeric keypad that appears on the remote control panel. (Supported only for MFR-39RU/39RUA.)

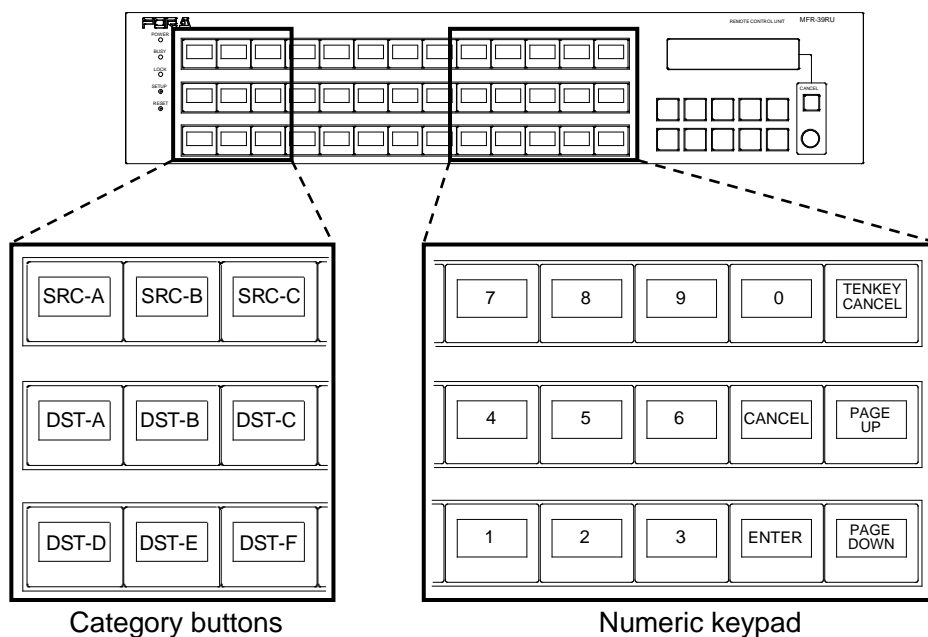

Category buttons: Allows you to select a category from which to select a channel using the numeric keypad.

- TENKEY CANCEL: Allows you to exit TENKEY mode. The entered number is indicated on the button when "SETTING > TENKEY MOD (INPUT MODE)" is set to **ENTER**.
- PAGE UP / DOWN: Allows you to change pages for the category buttons.
- ENTER / CANCEL: Allows you to confirm or cancel the change when "SETTING > TENKEY MOD (INPUT MODE)" is set to **ENTER**. If it is set to **DIRECT**, entering a value will change and confirm the selection.
 - ▶ See Sec. 5-4-3-9. "TENKEY MOD."
- 0 to 9 (numeric keys): Allows you to select a channel in the selected category. The TENKEY NO (INPUT START NO) menu allows you to select whether to count from 0 or 1.
 - ▶ See Sec. 5-4-3-10. "TENKEY NO."

◆ **Source channel selection using the numeric keypad function**

If categories are set as; SRC-A (SRC 1 to 13), and SRC-B (SRC 14 to 20)

(ex.1) TENKEY MOD (INPUT MODE) is **ENTER** and TENKEY NO (INPUT START NO) is **1**.

- Select SRC-A, enter 3 on a numeric keypad and press ENTER to select SRC 3.
- Select SRC-B, enter 5 on a numeric keypad and press ENTER to select SRC 18.

(ex. 2) TENKEY MOD (INPUT MODE) is **DIRECT** and TENKEY NO (INPUT START NO) is **0**.

- Select SRC-A, and enter 3 on a numeric keypad to select SRC 4.
- Select SRC-B, and enter 0 on a numeric keypad to select SRC 14.

- ▶ See Sec. 5-4-3-12. "BTN ASSIGN" for details on how to assign the **TENKEY** button.

6-1-2. A Crosspoint Switching Using a Bus Button

A button to which a destination channel and source channel for the destination is assigned is called a bus button in the remote control panel. The bus buttons allow you to change source channels to be output from destination channels by the push of a button.

Bus button crosspoint switching can switch crosspoints regardless of the current destination selection.

- ▶ See Sec. 5-3. "Function Buttons" for details on button assignments.
- ▶ See Sec. 5-4-3-12. "BTN ASSIGN" and 5-5-2. "Button Assignment Change" for details on how to assign the bus buttons.

6-1-3. CHOP Function

The CHOP function allows you to alternate 2 images to compare the images.

◆ Enabling the CHOP function

- (1) Press one of 2 source buttons (source A) to compare the images.
- (2) While holding down the source button, press and release another source button (source B).

Source A and B images alternate.

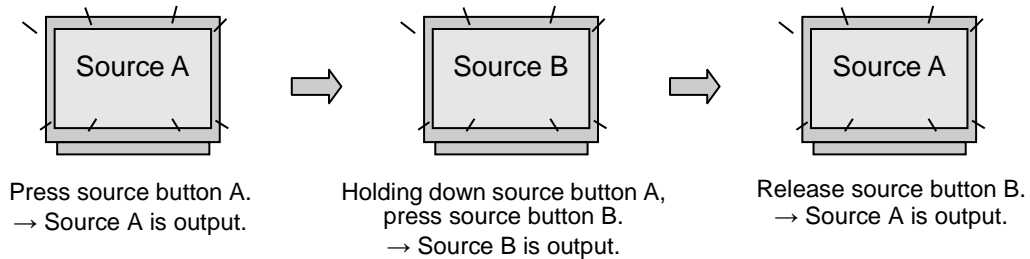

6-1-4. Crosspoint Switching Using TAKE Function

Crosspoint switching using the **Take** function is available by the remote control panel that is assigned **Take**.

The **Take** function enables crosspoint switching by the **TAKE** button.

The **Take** function has 2 modes that can be assigned to different remote control panel respectively. To select the Take mode, select **Preset** or **Direct** under **Take Mode** in the [Web-based Control: **RU Settings** page].

◆ Preset mode

Press the **TAKE** button to enable Take, and select crosspoints, then press the **TAKE** button to switch crosspoints.

◆ Direct mode

The Take function is always enabled. Select crosspoints, then press the **TAKE** button to switch crosspoints.

- Ex.1: To use the **TAKE** button assigned to Preset mode

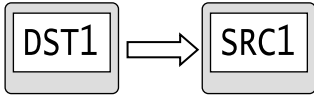
Step	Description
1	Press the TAKE button. The take function will be enabled, and the button will be highlighted. 
2	Select a crosspoint by selecting a destination button and source button. The selected buttons will blink.  * To switch multiple crosspoints, repeat the procedure.
3	After completing the crosspoint selection, press the blinking TAKE button to switch the crosspoint/s. In multiple crosspoint switching, the last set of destination and source buttons will be highlighted.

Once a crosspoint switch has been completed, the **TAKE** button preset mode will be disabled. The button will return to direct mode.

To switch crosspoints in the preset mode again, repeat the procedure from step 1.

- Ex. 2: To use the **TAKE** button assigned to Direct mode

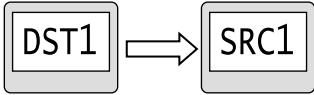
Step	Description
1	<p>In Direct mode, the Take function is always enabled.</p> <p>Select a crosspoint by selecting a destination button and source button. The selected buttons will blink.</p> <p style="text-align: right;">  </p> <p>* To switch multiple crosspoints, repeat the procedure.</p>
2	<p>After completing the crosspoint selection, press the blinking TAKE button to switch the crosspoint/s.</p> <p>In multiple crosspoint switching, the last set of destination and source buttons will be highlighted.</p>

6-2. Simultaneous Crosspoint Switching

The simultaneous crosspoint switching function allows you to **simultaneously switch multiple crosspoints** by the press of one button. There are two ways to do so. One is the Salvo function which performs the switching by recalling the pre-assigned crosspoints. The other is the Take function which allows you to assign and switch multiple crosspoints simultaneously.

The SALVO crosspoints can be saved to the **routing switcher main unit** and **buttons on the remote control panel** and **front panel**.

6-2-1. Main Unit Stored Salvos

This type of salvo allows you to store crosspoint data to be simultaneously switched. The stored data can be recalled from any connected remote control panel.

◆ Storing Salvo Data to Main Unit

Salvo data for Main Unit can be stored using the Web-based Control.

- ▶ See [Web-based Control: **Salvo** page]

◆ Executing Salvos

Use a **SALVO** (MU RECALL) button on the remote control panel as shown in the procedure below.

- (1) Assign a **SALVO** button on the remote control panel. Set the salvo for **MU RECALL**, and select a Salvo number.
 - ▶ See Sec. 5-4-3-12 "BTN ASSIGN" and 5-5-2. "Button Assignment Change"
- (2) Pressing the **SALVO** button to executes the salvo. The crosspoints stored to the salvo number are simultaneously set.

6-2-2. Remote Control Stored Salvos

This type of salvo allows to you assign crosspoints to be simultaneously switched to a button. The salvo can be recalled only by the **SALVO** button on the remote control panel. Once a salvo is executed, crosspoints assigned to the salvo are switched according to the current remote control level setting.

Remote Control Stored Salvo data can also be stored using the Web-based Control.

- ▶ See [Web-based Control: **Salvo** page]



◆ **Storing Salvo Data to the Remote Control Unit (MFR-39RU/39RUA only)**

Use a **SALVO** (RU STORE) button on the remote control panel as shown in the procedure below.

(1) Assign a **SALVO** button on the remote control panel. Set the salvo for **RU STORE**.

▶ See Sec. 5-4-3-12 "BTN ASSIGN."

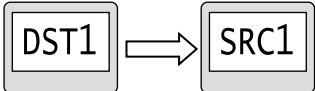
(2) Store salvo data as shown in the table below.

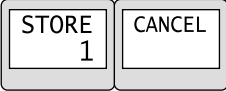
Step	Description
1	Press the SALVO button as shown below. The button is highlighted and ready for crosspoints to be assigned. 
2	To assign crosspoints to a salvo, press a destination button then a source button. The selected buttons flash.  Repeat the procedure for all crosspoints.
3	MFR-39RU: After completing the crosspoints assignments, press the SALVO button again. The menu display appears as shown below.  MFR-39RUA: After completing the crosspoints assignments, press the SALVO button again. The Current DEST and SRC button displays change as shown below. 
4	MFR-39RU: To add crosspoints to an existing salvo, select a salvo number by turning the control knob. Salvo numbers to which no crosspoints are assigned are indicated with (NEW). Turn the control knob to select a number, and press the knob to confirm the selection. MFR-39RUA: Turn the control knob to select a number then press the control knob to confirm the selection.

◆ **Executing Salvos**

Use a **SALVO** (RU RECALL) button on the remote control panel as shown in the procedure below.

(1) Assign a **SALVO** button on the remote control panel. Set the salvo for **RU RECALL**, and select a Salvo number.

▶ See Sec. 5-4-3-12 "BTN ASSIGN" and 5-5-2. "Button Assignment Change."

(2) Pressing the **SALVO** button to executes the salvo. The crosspoints stored to the salvo number are simultaneously set.

6-2-3. Front Panel Stored Salvos

This type of salvo allows to you assign crosspoints to be simultaneously switched to a front panel button.

◆ Storing Front Panel Salvo Data

Front panel salvo data can be stored using the Web-based Control.

▶ See [Web-based Control: **Salvo** page]

◆ Executing Salvos

Use a **SALVO** (SALVO RECALL(FP)) button on the front panel as shown in the procedure below.

(1) Assign a **SALVO** button on the front panel. Set the salvo for **FP RECALL**, and select a Salvo number.

▶ See Sec. 4-4-4. "Button Assign screen."

(2) Pressing the **SALVO** button to executes the salvo. The crosspoints stored to the salvo number are simultaneously set.

6-2-4. Simultaneous Switching Using the Take Function

The **TAKE** button on the remote control panel allows you to simultaneously switch preset crosspoints.

▶ See Sec. 5-4-3-12 "BTN ASSIGN" for details on assigning the **TAKE** button.

◆ Executing a TAKE

See the Ex. 1) and Ex. 2) in section 6-1-4. "Crosspoint Switching Using TAKE Function" for the procedure.

6-2-5. Simultaneous Switching by the Link Function

The **LINK** button on the remote control panel allows you to simultaneously switch crosspoints associated with a specific crosspoint.

Pressing the **LINK** button enables or disables the Link function. The **LINK** button is highlighted with a bright background when the function is enabled.

▶ See Sec. 5-4-3-12 "BTN ASSIGN" for details on assigning the **LINK** button.

If the Link function is turned on, selecting a trigger crosspoint switches the slave crosspoints with it. The trigger and slave crosspoints can be assigned using Web-based Control.

▶ See [Web-based Control: **Link Settings** page] for more details.

6-3. Lock

Function operation and crosspoint changes can be disabled by the Lock function.

◆ LOCK Function

The Lock function is a function that inhibits the use of function buttons or crosspoint changes. There are three types of Lock functions.

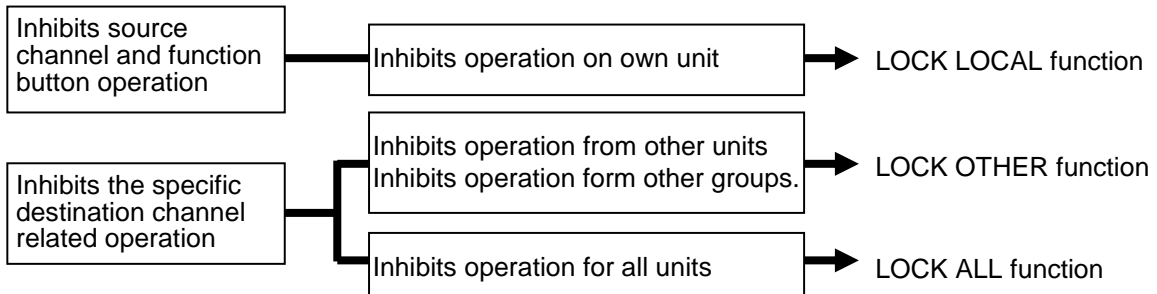

6-3-1. LOCK LOCAL

The Lock Local function inhibits operation of buttons and menus that change the source channel or sets or executes Take switching on the unit that enabled the Lock function. (Selecting destination channels is not inhibited.)

This function is used in protecting the system from unintended operation.

◆ Enabling LOCK LOCAL

(1) Assign **LOCK LOCAL** to a button on the control unit.

▶ See Sec. 5-4-3-12 "BTN ASSIGN" and 5-5-2. "Button Assignment Change."

(2) Press the assigned **LOCK LOCAL** button to enable the Lock Local function.

* Operations are locked for units in black boxes and unlocked for units in white boxes.

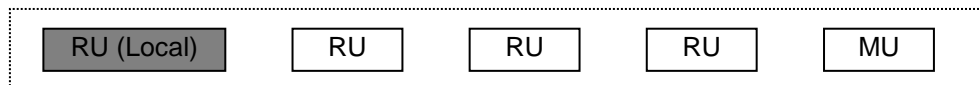

◆ Disabling LOCK LOCAL

Press the **LOCK LOCAL** button again.

If LOCK LOCAL is ON:

On the remote control panel:

- LOCK LED is lit green
- **LOCK LOCAL** is highlighted (background of the text illuminates.)
- Source and bus button indications are crossed.

To check the **LOCK status**, press the current destination button.
The MENU display shows the LOCK status (ON or OFF) as shown below.

DST: 8 [DST8] LK-LOCAL [PANEL LOCK]	DST: 8 [DST8] LK-OFF [NOT LOCKED]
--	--

The **LOCK LOCAL** button and LOCK LED on the remote control panel flash if any inhibited operation such as changing the source channel is performed when Lock Local is enabled. (Only if the **LOCK LOCAL** button is assigned.)

LOCK LOCAL can be issued only on Remote Control Units.

6-3-2. LOCK OTHER / LOCK ALL

The Lock Other and Lock All functions disable crosspoint changes for current destination channels to all other units or all units including the unit that enabled the Lock function. Lock functions can be disabled only from the unit that enabled the function.

In multi-panel operation, lock functions can be disabled from any remote control panel in the operation system. Lock Other does not disable operation of remote control panels in the system.

◆ Enabling LOCK OTHER/LOCK ALL

<Setting on the Remote Control Panel>

- (1) Assign **LOCK OTHER** or **LOCK ALL** to a button on the remote control unit.
 - ▶ See Sec. 5-4-3-12 "BTN ASSIGN" and 5-5-2. "Button Assignment Change."

- (2) Press the assigned button to enable the Lock function.

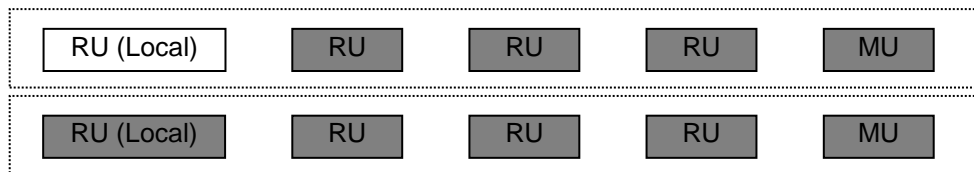

<Setting in the Web-based Control>

Open the [Web-based Control: **Lock Destination** page, and assign a lock button.

◆ Disabling LOCK OTHER/LOCK ALL

Press the lock button again.

To unlock buttons from other units, press and hold the **LOCK** button for the time specified in the [Web-based Control: **RU Settings** page].

If LOCK OTHER or LOCK ALL is ON:

On the remote control panel:

- LOCK LED illuminates
Orange, if a LOCK OTHER command is sent by itself.
Red, if a LOCK OTHER command is sent by another unit.
Red, if a LOCK ALL command is sent by any unit.
- The **LOCK** button is highlighted (background illuminates)
- LED and LCD colors of locked current destination buttons are changed to those set under **LockButtonColor** in the [Web-based Control: **RU Settings** page] (MFR-40/ 18/ 39RU, 16RUTA)

To check the **LOCK status**, press the current destination button.

The MENU display shows the LOCK status and the ID number of the unit that has issued the LOCK command.

DST: 8 [DST8]
LK-ID: 103[OTHER PANELS]

LOCK OTHER ON

DST: 8 [DST8]
LK-ID: 103[ALL PANELS]

LOCK ALL

DST: 8 [DST8]
LK-OFF [NOT LOCKED]

LOCK OFF

The **LOCK** button and LOCK LED on the remote control unit flash if any inhibited operation such as selecting a source channel is performed when Lock Other (or Lock All) is enabled and the **LOCK OTHER** (or **LOCK ALL**) button is assigned.

◆ **LOCK GROUP**

The LOCK OTHER function also enables Group LOCK OTHER, which allows crosspoint switching by RU units only in the same group and locks RU switching in other groups. Any RU in the same group can lock or release the LOCK OTHER command. LOCK ALL disables crosspoint switching from all remote control units and can be unlocked only by remote control units in the same group.

<**LOCK GROUP Setting Example**>

This example creates the following three groups from five RU units as shown below using the Unit ID and Group ID numbers.

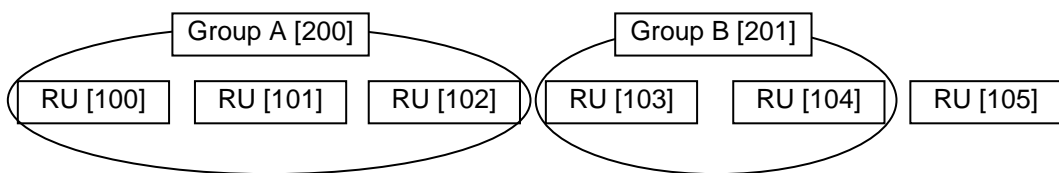

1. Open the [Web-based Control: **Lock Destination** page]. Add RU [100], RU[101] and RU[102] to Group A.
2. Add RU [103] and RU[104] to Group B.

Once an RU is added to a group, the LOCK OTHER/LOCK ALL button on the RU changes to a Group LOCK OTHER/LOCK ALL button.

When sending a LOCK OTHER command from RU[100], RU [103], RU[104] and RU[105] are locked (greyed out in the figure below) for the set crosspoint.



When sending a LOCK OTHER command from RU[103]...



When sending a LOCK OTHER command from RU[105]...



When sending Group LOCK OTHER/LOCK ALL commands, use a Group ID number in the [Web-based Control :**Lock Destination** page].

If operating in Multi-panel mode, all linking RU devices must belong to the same group.

6-4. Preview Function

The preview function allows you to set an output to be used for the preview.

(ex.) When pressing a source button on the remote control panel for a simultaneous crosspoint switch, the selected source will be output to the preview output. Then you can check images of the source channels to be assigned to a Take.

When pressing a destination button, the source channel assigned for the destination channel will be output to the preview output.

◆ **Assigning Operation Preview to a Button on the Remote Control Panel**

The Operation Preview function is disabled as default. To enable the function, assign the function to a button on the remote control panel in the Web-based Control.

Only MFR-39RU and MFR-16RUD units can assign Operation Preview on the front panel operation.

- ▶ See [Web-based Control: **Assign Function** page].
- ▶ See sections 5-4-3-12. "BTN ASSIGN" and 5-5-2. " Button Assignment Change."

◆ **Outputting the Operation Preview**

Press the **O-PREVIEW** button on the remote control unit to output the preview signal from the set destination channel.

6-5. Level Control

Generally, routing switchers control crosspoints according to the signal types such as video, audio, time codes, and VCR control. To control switchers, level numbers are used to identify which type of signal to control.

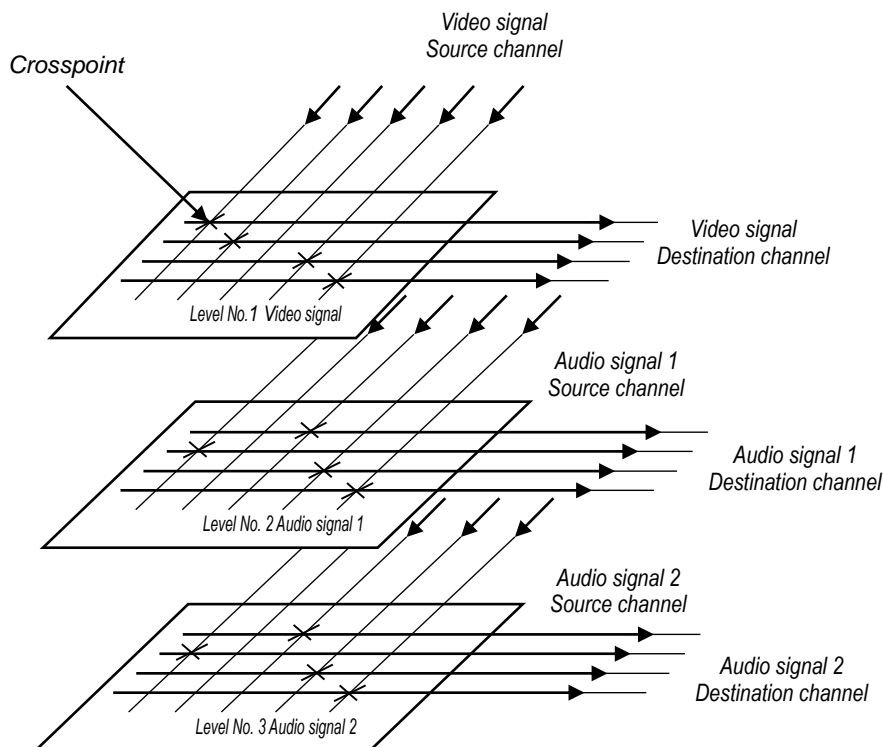

In the above example, if you select Level No. 1 for the current level, you can switch crosspoints that are set to Level 1. If you select Level No. 2, you can switch crosspoints on Level 2. If you select multiple levels, you can switch crosspoints on all of the selected levels at the same time.

◆ Assigning levels

Signals can be assigned to logical inputs and outputs using Web-based Control. When assigning the signals, select a level for respective signals to be assigned to the respective levels.

- ▶ See the separate MFR SERIES Web-based Control Operation Manual for details on assigning levels using Web-based Control.

◆ Selecting levels on remote control panels

The remote control panel can select channels on the current level. The level selections can be changed using the **LEVEL** button or control knob. Multiple levels can be set to the current levels by the **LEVEL** button or control knob.

Pressing the respective **LEVEL** button allows you to go to the respectively assigned levels.

To change levels on remote control panels using the Control knob, press the **MODE** button and select Level mode in the mode menu.

- ▶ 5-4 “MODE Button and Mode Menu (MFR-39RU/18RU/16RUTA/39RUA/18RUA).”

6-5-1. Level Indication on the Remote Control Panel

The MFR main unit and remote control panel can control signals on multiple levels at the same time. The remote control panel indicates the current level(s) by hexadecimal numbers in the menu display and on the LCD.

(ex.1) If all levels 1 through 8 are enabled, the indication is "00FF".

Level 8: ENBL 7: ENBL 6: ENBL 5: ENBL 4: ENBL 3: ENBL 2: ENBL 1: ENBL
⇒ F F

(ex. 2) If levels 3, 4, 6, and 7 are enabled, the indication is "006C".

Level 8: DSBL 7: ENBL 6: ENBL 5: DSBL 4: ENBL 3: ENBL 2: DSBL 1: DSBL
⇒ 6 C

* ENBL: enabled
DSBL: disabled

If multiple levels are selected to the current levels, the smallest enabled level number is indicated in the menu display and on the button.

In the above case (ex.1): indicated as Level1

In the above case (ex.2): indicated as Level3

7. Multiview Output

The MFR-16MV card allows you to output multiview images using any two BNC connectors, in which up to 16 video windows and two clocks can be displayed on a single or dual multiview screen.

◆ Process Block Diagram

Any router sources can be used as multiview window sources. Assign multiview output to desired destination channel(s). Other ports on the card can function as router destination channel outputs.

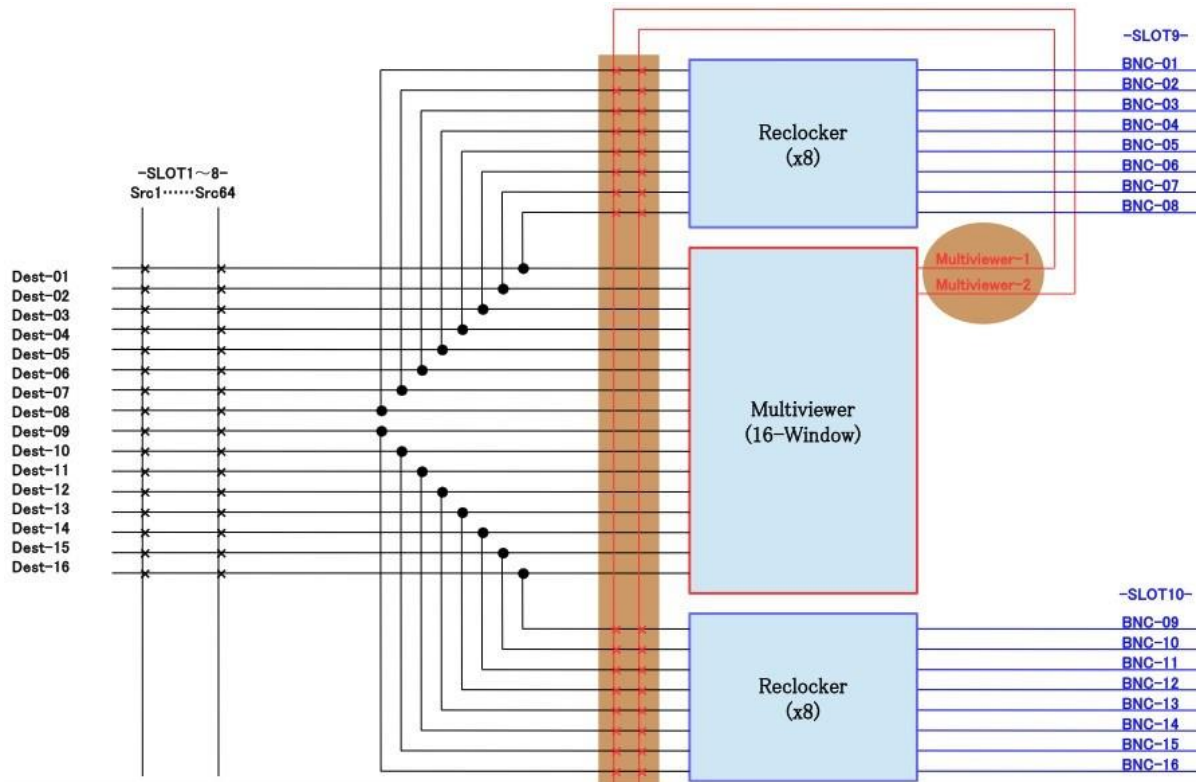

7-1. Multiviewer Specifications

Item	Specifications	
Video format	3Gbps (Level-A)	1080/60p, 59.94p, 50p
	1.5Gbps (HD)	1080/60i, 59.94i, 50i, 720/60p, 59.94p, 50p, 1080/30p, 29.97p, 25p, 24p, 23.98p, 1080/30psF, 29.97psF, 25psF, 24psF, 23.98psF
Video input	SDI 75Ω BNC 16 inputs	
Video output	SDI 75Ω BNC x 16	
Audio output (Except MV outputs)	Embedded (SDI) - Group x 4, 8 stereo pairs - Sampling frequency: 48 kHz - Quantization bit: 24-bit	
Input/output delay	1 frame (with synchronous inputs)	
Number of windows	16 video windows and 2 clocks (selectable from 10 types)	
Window size	16, 9 or 4	

Other objects	<ul style="list-style-type: none"> - Background (Input image, MATT or BLACK) - Text (8 characters x 2) - Window frame (normal or tally) - Tally marker - Audio level meter (16 channels) - Timecode - Video loss
Layout pattern registers	16 (16 per a single MFR-3000 unit)
Layout Manager	Screen and window layout creation and editing in Web-based Control * Window and text locations are arbitrary.
Clock time	<ul style="list-style-type: none"> - Source: Internal clock source - SNTP adjustment available - Power source: Built-in lithium battery
Loop playback	Sequence display of input sources (up to 64 inputs) on a multiview screen
Adjustable timing	-0.5H to +1.5H

Use input sources that are synced to the external reference.

7-2. Displaying Multiview Images

At first, select Destination channels used for multiview images in the Web-based Control.

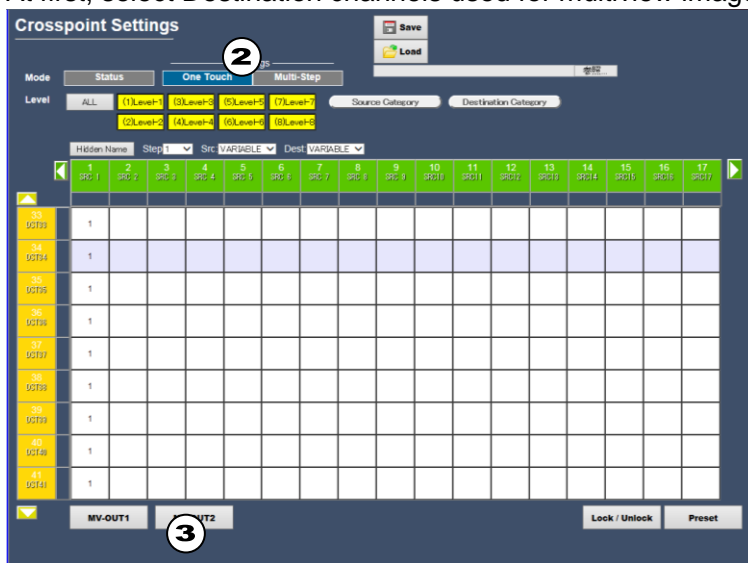

- (1) Open the [Web-based Control: **Crosspoint Status** page].
- (2) Press **One Touch**.
- (3) Select Destination channels for a multiview image and press **MV-OUT1** or **MV-OUT2**.

7-3. Basic Rules for Creating Multiview Layouts



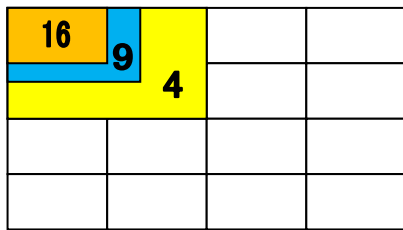





- Three types of windows, **16**, **9** and **4**, are available.

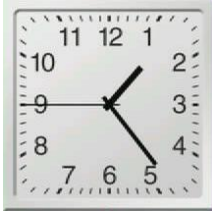

- Although windows are shared between MV-OUT1 and MV-OUT2, window duplications are not allowed. For example, if Window 1 is displayed on MV-OUT1, MV-OUT2 cannot display Window1.
- Windows can be placed at any location, but the following objects must be separated, not overlapped. (Otherwise, images will appear distorted.)
 - (a) Windows.
 - (b) Clock and timecode
 - (c) Window and clock titles
- Background images can be selected from 16 window sources and matte and black images. (MV-OUT1 and MV-OUT2 can use different background images, but the same color if both use Matte. For 1080/60p, 59.94p and 50p signals, the background images for MV-OUT1 and MV-OUT2 are the same.)

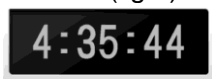

7-4. Clocks

The following 10 clock types are available.

Analog clock 1 Round - Time 	Analog clock 2 Square - Time 	Analog clock 3 Square (light) - Date/Time 	Analog clock 4 Square (dark) - Date/Time 
Analog clock 5 Round (light) - Date/Time 	Analog clock 6 Round (dark) - Date/Time 		
Digital clock 1 Time (dark) 	Digital clock 2 Time (light) 	Digital clock 3 Date/Time (light) 	Digital clock 4 Date/Time (dark) 

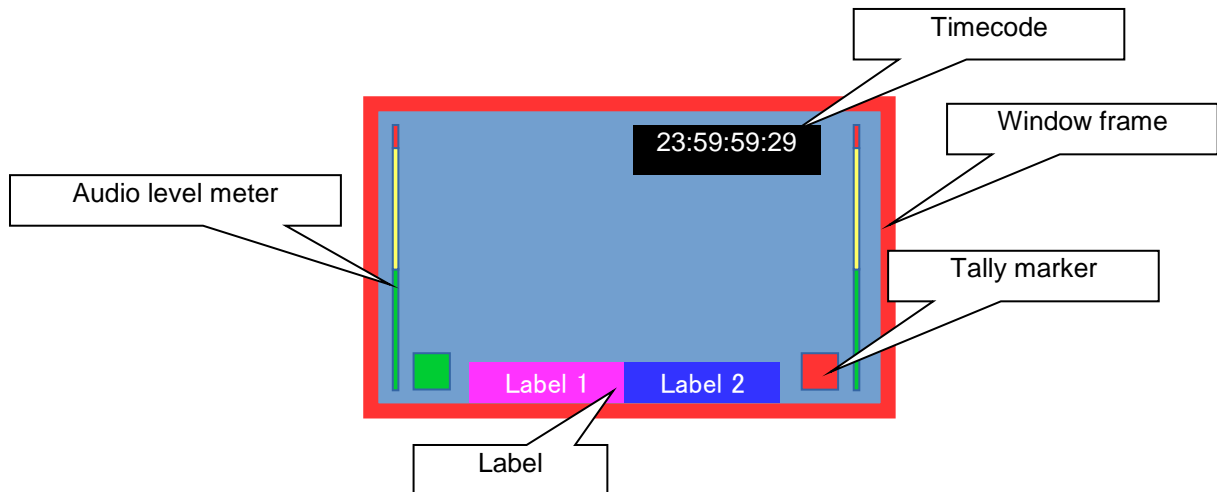
7-5. Available Window Objects

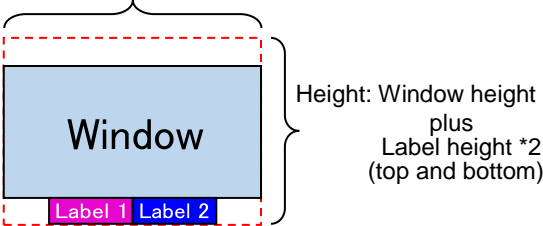

<p>Label</p>	<p>Label 1 and Label 2 can display simultaneously. Label 1 and Label 2 are concatenated. Size: Select from 3 sizes. Label text: Select from Title, Alarm and Title+Alarm. Title: Displays channel names or text specified by DP-ID. Text and background colors are selectable. Label 1 is assigned to Title1 and Label 2 to Title2. Alarm: Displays text only when an alarm occurs. Title + Alarm: Displays alarms. Titles are displayed when no alarm has been occurred.</p> <p>Labels can be placed within the red rectangle in the figure below. Width: Window width</p> <div style="text-align: center;">  </div>
<p>Frame</p>	<p>Width: Select from 4 types. Color: Select from 8 colors. Also available as tally frame (in accordance with DP-ID information assigned to labels)</p>
<p>Tally marker</p>	<p>Can be placed freely anywhere within windows. Tally information is displayed according to DP-ID information assigned to labels.</p>
<p>Audio level meter</p>	<p>Layout: Select from the following 4 types (①-③ in 4K mode)</p> <div style="text-align: center;">  </div>
<p>Timecode</p>	<p>Size: Select from 3 types. Location: Same area as that of labels Text and background colors selectable</p>

8. Gearbox Feature (MFR-8SDIGB/8SDOGB)

Optional **MFR-8SDIGB/8SDOGB** cards support Gearbox features, in which video signal conversions between 12G-SDI and Quad Link 3G-SDI, and between 2SI and SQD are available.

◆ Gearbox features

- Conversion between 12G-SDI and Quad Link 3G-SDI (including asynchronous input)
- Conversion between 2SI and SQD
- Clean switch after conversion by AVDL (Automatic Variable Delay Line)
Also allows Gearbox I/O delay selection (excluding 2SI / SQD conversions)
- Genlock or Line lock synchronization
- H/V ANC data pass-through

8-1. MFR-8SDIGB / 8SDOGB Cards

MFR-8SDIGB / 8SDOGB cards have two built-in Gearboxes that can respectively perform signal conversions and output test patterns.

Only 1D and 2D connectors can support 12G-SDI signals. If a 12G-SDI signal is input to a Gearbox, A, B and C connectors are disabled.

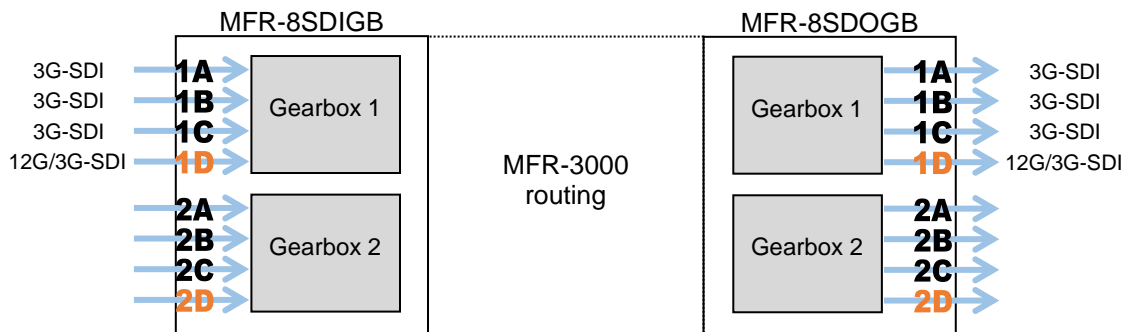

◆ Supported formats

Signal format		Video format		Standard
12G-SDI		3840 x 2160/59.94p 3840 x 2160/50p	4:2:2 10-bit	SMPTE ST2082-10
Quad Link 3G-SDI (Level-A)	SQD (Square Division)	3840 x 2160/59.94p	4:2:2	SMPTE ST425-5
	2SI (2-Sample Interleave)	3840 x 2160/50p	10-bit	

8-2. Available Conversions

◆ MFR-8SDIGB cards allow following input conversion settings:

From	To	Lock	Delay(H) ^{(*)3}	Total Delay ^{(*)4}	Ancillary Data
12G-SDI	3G Quad (2SI)	Line lock ^{(*)1}	0.3H~1H	0 frame + ** (H)	Through Mask
		Genlock	0.3H~1H	0 frame + ** (H) 1 frame + Delay (H)	
			0.5H to 1H	1 frame + 0H	
12G-SDI	3G Quad (SQD)	Line lock ^{(*)1} (*)2) Genlock	0.3H~1H	1 frame + Delay (H)	
3G Quad (2SI)	3G Quad (SQD)				
3G Quad (SQD)	3G Quad (2SI)				

◆ MFR-8SDOGB cards allow following output conversion settings:

From	To	Lock	Delay(H) ^{(*)3}	Total Delay ^{(*)4}	Ancillary Data
3G Quad (2SI)	12G-SDI	Line lock ^{(*)1}	0.3H~1H	0 frame + ** (H)	Through Mask
		Genlock	0.3H~1H	0 frame + ** (H) 1 frame + Delay (H)	
			0.5H to 1H	1 frame + 0H	
3G Quad (SQD)	12G-SDI	Line lock ^{(*)1} (*)2) Genlock	0.3H~1H	1 frame + Delay (H)	
3G Quad (2SI)	3G Quad (SQD)				
3G Quad (SQD)	3G Quad (2SI)				

(*1) SDI signal input to the D connector is used as reference. When Line Lock is selected on MFR-8SDOGB cards, video signals are synchronized by inputting signals to all four channels in gearboxes.

(*2) Available only on Gearboxes 2.

(*3) **Delay (H)** and **Total Delay (H)** indicate amount of delay and their settings correspond to the following adjustable ranges.

Delay (H) Setting	Adjustable range	Delay (H) Setting	Adjustable range
0.3H	-0.8H to +0.2H	0.8H	-0.3H to +0.7H
0.4H	-0.7H to +0.3H	0.9H	-0.2H to +0.8H
0.5H	-0.6H to +0.4H	1H (1)	-0.1H to +0.9H
0.6H	-0.5H to +0.5H	1H (2)	-0.5H to +0.5H
0.7H	-0.4H to +0.6H		

(*4) If **Total Delay (frame)** is set to "0 frame" for both gearboxes, the **different Total Delay (H)** setting is available for the gearboxes.

If **Total Delay (frame)** is set to "1 frame" for either one or both gearboxes, the **same Total Delay (H)** setting is required for the gearboxes: **1 frame + 0H** or **1frame + Delay (H)**.

8-3. Conversion Settings

In the Web GUI, specify the Gearbox input and output formats, and then assign input/output physical channels to logical channels. Use Link Settings that allow simultaneous 4-channel operation and facilitate crosspoint switches.

8-3-1. Converting 3G SQD Input to 2SI (MFR-8SDIGB)

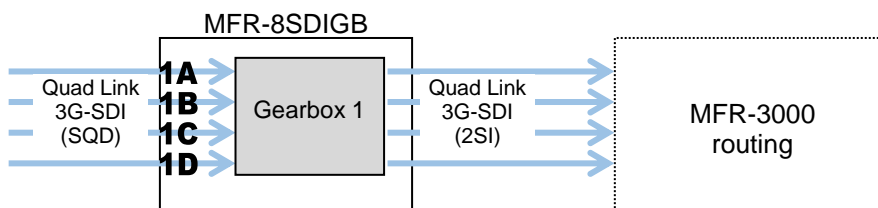

- 1) Open the **Gearbox Settings** page in the Web GUI and select signal formats under **From** and **To** as shown below for a Gearbox in the MFR-8SDIGB card block. (This example sets Gearbox 1 on the Slot 1 card.)

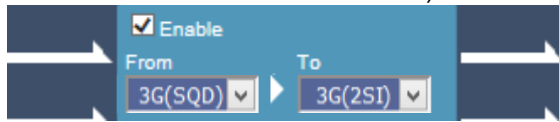

- 2) Open the **Source Assignment** page in the Web GUI and assign the physical channels (**SDI1-4**) to logical channels (**SRC 1-4**).

LogicalNo. / Name	Slot	Physical No.
1 SRC 1	1:MFR-8SDIGB	SDI 1
2 SRC 2	1:MFR-8SDIGB	SDI 2
3 SRC 3	1:MFR-8SDIGB	SDI 3
4 SRC 4	1:MFR-8SDIGB	SDI 4

- 3) Use a remote control unit or the Crosspoint page in the Web GUI to assign output channels to **SRC1-4**.

	1 SRC 1	2 SRC 2	3 SRC 3	4 SRC 4
5 SDI 5	1			
6 SDI 6		1		
7 SDI 7			1	
8 SDI 8				1
9 SDI 9				

8-3-2. Converting 2SI to SQD Output (MFR-8SDOGB)

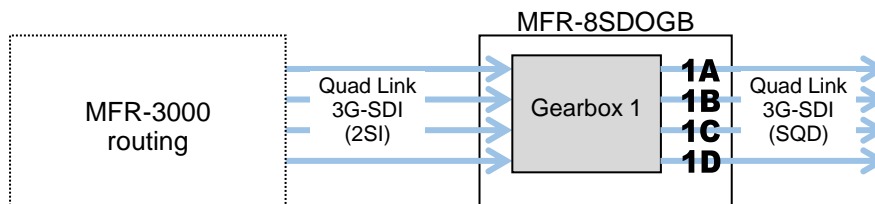

- 1) Open the **Gearbox Settings** page in the Web GUI and select signal formats under **From** and **To** as shown below for a Gearbox in the MFR-8SDOGB card block. (This example sets Gearbox 1 on the Slot 9 card.)



- 2) Open the **Destination Assignment** page in the Web GUI and assign the physical channels (**SDI1-4**) to logical channels (**DST 1-4**).

LogicalNo. / Name	Slot	Physical No.
1 DST 1	1:MFR-8SDOGB	SDI 1
2 DST 2	1:MFR-8SDOGB	SDI 2
3 DST 3	1:MFR-8SDOGB	SDI 3
4 DST 4	1:MFR-8SDOGB	SDI 4

- 3) Use a remote control unit or the Crosspoint page in the Web GUI to assign input channels to **DST1-4**.

8-3-3. Converting 12G-SDI Input to 3G-SDI 2SI (MFR-8SDIGB)

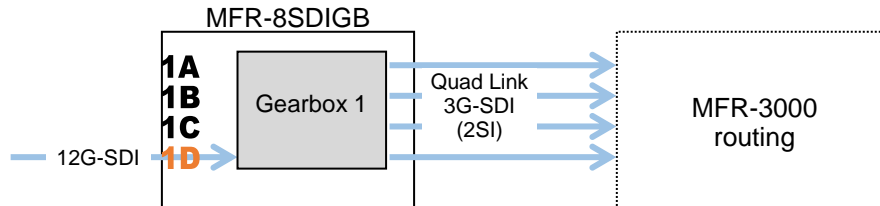

- 1) Open the **Gearbox Settings** page in the Web GUI and select signal formats under **From** and **To** as shown below for a Gearbox in the MFR-8SDIGB card block. (This example sets Gearbox 1 on the Slot 1 card.)



- 2) Open the **Source Assignment** page in the Web GUI and assign the physical channels (**SDI 4 Link A to D**) to logical channels (**SRC 1-4**).

LogicalNo. / Name	Slot	Physical No.
1 SRC 1	1:MFR-8SDIGB	SDI 4 Link A
2 SRC 2	1:MFR-8SDIGB	SDI 4 Link B
3 SRC 3	1:MFR-8SDIGB	SDI 4 Link C
4 SRC 4	1:MFR-8SDIGB	SDI 4 Link D

* Four channel assignments are required for 12G-SDI signals in the same manner as for Quad-Link 3G-SDI signals.

- 3) Use a remote control unit or the Crosspoint page in the Web GUI to perform the crosspoint switches.

8-3-4. Converting 3G-SDI SQD to 12G-SDI Output (MFR-8SDOGB)

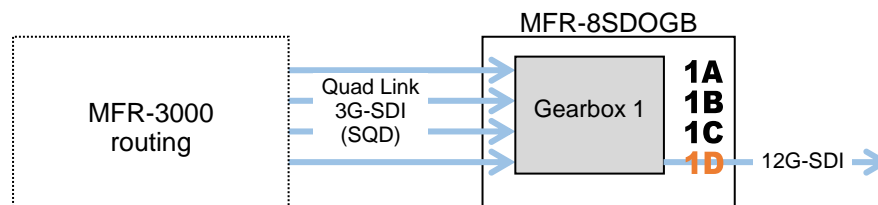

- 1) Open the **Gearbox Settings** page in the Web GUI and select signal formats under **From** and **To** as shown below for a Gearbox in the MFR-8SDOGB card block. (This example sets Gearbox 1 on the Slot 9 card.)



- 2) Open the **Destination Assignment** page in the Web GUI and assign the physical channels (**SDI 4 Link A to D**) to logical channels (**DST 1-4**).

LogicalNo. / Name	Slot	Physical No.
1 DST 1	1:MFR-8SDOGB	SDI4 Link A
2 DST 2	1:MFR-8SDOGB	SDI4 Link B
3 DST 3	1:MFR-8SDOGB	SDI4 Link C
4 DST 4	1:MFR-8SDOGB	SDI4 Link D

* Four channel assignments are required for 12G-SDI signals in the same manner as for Quad-Link 3G-SDI signals.

- 3) Use a remote control unit or the Crosspoint page in the Web GUI to perform the crosspoint switches.

9. Serial / LAN Command Control

Up to 20 external devices can be connected to an MFR Main Unit (including MFR-GPI serial ports) through LAN or serial interface.

9-1. Serial Interface

Crosspoint switchover and tally output can be controlled via the SERIAL ports on the MFR Series main unit or MFR GPI.

9-2. LAN Interface

The MFR Series main unit is able to connect to a third-party automatic control system via the RJ-45 port (PC-LAN port). The TCP/IP communication protocol is supported. The control PC will be the Client, and the MFR Series main unit will be the Server.

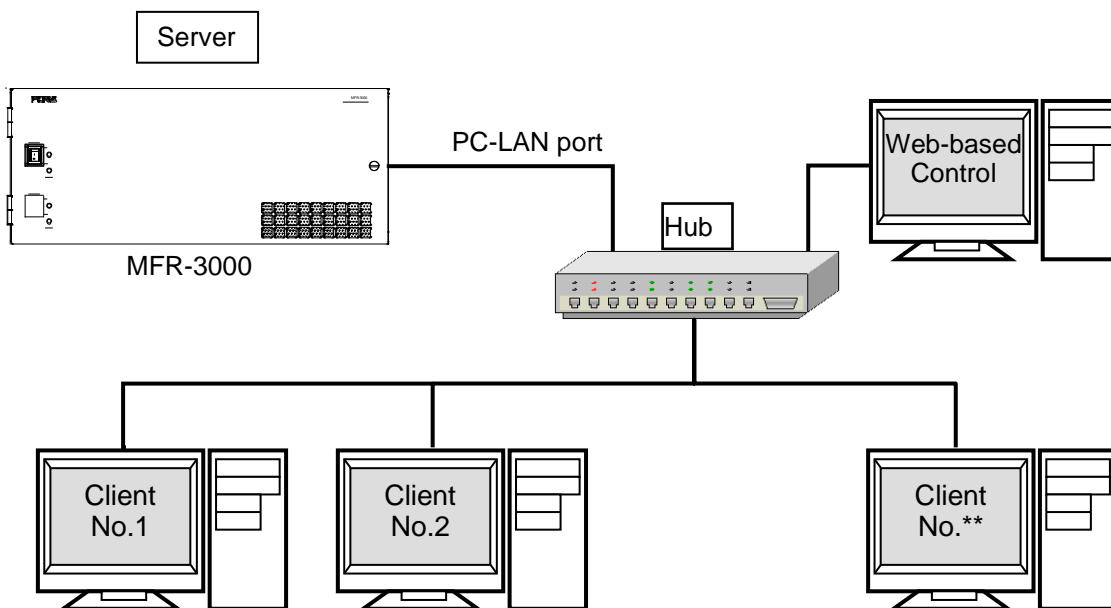

◆ Basic specifications

Item	Description
IP address (PC-LAN port)	192.168.1.12 (Subnet Mask: 255.255.255.0)
Port number	Setting range: 49152 to 65534 (Default: 23)
Number of PCs	Max. 16
Response / Resending	Wait before sending next command (Resend if the Echo is not returned.)
Login password	None
Communication protocol	TCP/IP, Control PC: Client, MFR-3000: Server Crosspoint Remote Control using ASCII code.
Command protocol	Crosspoint Remote Control protocol

9-3. Control Command

The control command list below shows the standard control commands for **Crosspoint remote control** and **Crosspoint remote control 2** protocols, which are available for both LAN and serial interfaces.

◆ Control command list

	Function	Serial	LAN *1	Protocol *2
1	Commands (S?) for requesting the crosspoints list	Yes	Yes	Crosspoint remote control / Crosspoint remote control 2
2	Commands (X?) for requesting information on crosspoints (by specifying a destination and level.)	Yes	Yes	
3	Commands (X:) for switching over a crosspoint (single channel)	Yes	Yes	
4	Commands for switching over crosspoints (multi-channel simultaneous switchover)	Yes	Yes	
5	Commands (W:) for locking a destination	Yes	Yes	
6	Commands (z:) for reinitializing a unit	Yes	—	
7	Commands (K?) for requesting input/output channel names	—	Yes	Crosspoint remote control 2
8	Commands (A?) for requesting CPU status.	—	Yes	
9	Commands (W?) for requesting Destination Lock status.	—	Yes	

*1 When commands are sent via LAN, an Echo, Prompt, S response and other response messages may be included in a single packet or divided into two or more packets. Therefore, do not process commands in a per packet basis but a per stream basis.

*2 A command protocol should be selected in the [Web-based Control: **Port Settings** page].

◆ Command formats

Func.	Control command	Command response	Ref.
1	@[sp]S?<Lvl>	S:<Lvl><Dest>,<Src>	—
2	@[sp]X?<Lvl><Dest>	S:<Lvl><Dest>,<Src>	—
3	@[sp]X:<Lvls>/<Dest>,<Src>	S:<Lvl><Dest>,<Src> C:<Lvls>/<Dest>,<Src>[....[S<Salvo number>]][L<Link number>]]:l<ID>	—
4	Clear a preset crosspoint. @[sp]B:C		—
	Preset a crosspoint. @[sp]P:<Lvl>/<Dest>,<Src>		
	Read a preset crosspoint specifying a level and destination. @[sp]P?<Lvl><Dest>	V:<Lvl><Dest>,<Src>	
	Read preset crosspoints for all channels in the specified level. @[sp]V?<Lvl>	V:<Lvl><Dest>,<Src>	
	Perform the preset crosspoints simultaneously. @[sp]B:E	S:<Lvl><Dest>,<Src> C:<Lvls>/<Dest>,<Src>[....[S<Salvo number>]][L<Link number>]]:l<ID>	—
5	LOCK ALL units. @[sp]W:<Lvl>/<Dest>,<ID>,1	W!<Lvl><Dest>,<ID>,1	6-3-2
	LOCK OTHER units. @[sp]W:<Lvl>/<Dest>,<ID>,2	W!<Lvl><Dest>,<ID>,2	6-3-2
	Disable LOCK. @[sp]W:<Lvl>/<Dest>,<ID>,0	W!<Lvl><Dest>,<ID>,0	6-3-2
6	@[sp]z:<Lvls>	S:<Lvl><Dest>,<Src> C:<Lvls>/<Dest>,<Src>[....[S<Number of crosspoints in Salvo>]][L<Number of Links>]]:l<ID>	—
7	@[sp]K?<SorD><AorK>,<Ofset>	K:<SorD><AorK><No.>,<Dat>	9-3-3
8	@[sp]A?	If CPU is active: @[sp]A:<ID>	9-3-4
		If CPU is passive: (No response)	
9	@[sp]W?<Lvl>,<Dest>	W!<Lvl><Dest>,<ID>,0-2* *0: Nothing locked 1: LOCK ALL 2: LOCK OTHER	9-3-5

- * [sp] indicates a space.
- * Commands must end with a carriage return (ASCII code 0x0D) only or carriage return and line feed (ASCII code 0x0A). MFR units add a **carriage return** and **line feed** in front of and at the end of reply messages.

Command parameters and setting range

<Lvl>	0 - 7	Allows you to specify the level to switch crosspoints. * When in single-level operation.
<Lvls>	0 - 7	Allows you to specify the levels to switch crosspoints. * When in multiple-level operation
<Dest>	000-0FF	Allows you to specify the crosspoint switchover destination.
<Src>	000 - 0FF	Allows you to specify the source of crosspoint switchover.
<ID>	0 - FE	Unit ID. The ID must be different from that of other devices in the same network. Use 1 to FE for ID numbers. The host returns 0 when the lock is released.

* All command values are in hexadecimal, starting from 0 (zero).
(For example, Source "16" is represented as <Src>"F.")

* If levels are not in use, set <Lvl> or <Lvls> to "0"(zero).

9-3-1. Command Responses (Commands 1-6)

● Echo and Prompt

Responses will be sent as shown below when receiving commands:

A command is received. ↓ Echo ↓ Prompt	<pre>@[sp]X:<Lvls>/<Dest>,<Src>[CR] [CR][LF]></pre>
--	--

* MFR units respond with an Echo Reply with the same data that they received. Therefore, echo reply messages end with [CR][LF] or [CR] only. If echo messages with [CR][LF] are received, only [LF] composes the second line.

* MFR units read a command, ended with a newline, and return a prompt to notify that they are ready to receive a new command.

* A carriage return and line feed are not added at the end of "Echo Reply" and "Prompt"

● "C" responses

A "C" response is sent as shown below when a control command is received:

<pre>[CR][LF]C:<Lvls>/<Dest>,<Src>[...][S<Salvo number>][L<Link number>]:I<ID>[CR][LF]</pre>
--

* C responses are sent to all the terminals in the system.

Parameter	Setting range	Description
<Salvo number >	1-FFF	The number of crosspoints that are to be changed simultaneously by Salvo settings. A response if 3 crosspnts are to be changed simultaneously: C:0/0,0...S2:IA
<Link number>	1-FFF	The number of crosspoints that are to be changed simultaneously by Link settings. A response if 2 crosspnts are to be changed simultaneously: C:0/0,2...L1:IA

● "S" responses

An "S" response is sent as shown below when crosspoints are switched by a command.

<pre>[CR][LF]C:<Lvls>/<Dest>,<Src>[...][S<Salvo number>][L<Link number>]:I<ID>[CR][LF]</pre>
--

* If a crosspoint is switched by an X or B command, its "S" response is sent to all the terminals in the system. However, if any crosspoints are not switched (specifying the same crosspoint as the current one), its "S" response is sent only to the terminal that sent the command.

* C responses are sent before S responses in some cases.

* A command is received from another terminal while a B or X command is processed, MFR units send "S" response messages to the terminals, notifying only the latest crosspoint states.

* A crosspoint switch command is not performed if the relevant crosspoint is locked or inhibited to change.

Ex. 1) When **Source 5** is selected for **Destination 3** in **Level 1:**
(Function 3 in the previous page)

(A)	@ X:0/2,4[CR] [CR][LF]>	Terminal display:	@ X:0/2,4
(B)	[CR][LF] C:0/2,4:IA[CR][LF]		> C:0/2,4:IA
(C)	[CR][LF] S:02,4[CR][LF]		S:02,4

Ex. 2) When Source 113 is selected for Destination 49 in Levels 2 to 7:
(Function 3 in the previous page)

(A)	@ X:123456/30,70[CR] [CR][LF]>	Terminal display:	@ X:123456/30,70
(B)	[CR][LF] C:123456/30,70...S5:IA[CR][LF]		> C:123456/30,70...S5:IA
(C)	[CR][LF] S:130,70[CR][LF]		S:130,70
(C)	[CR][LF] S:230,70[CR][LF]		S:230,70
(C)	[CR][LF] S:330,70[CR][LF]		S:330,70
(C)	[CR][LF] S:430,70[CR][LF]		S:430,70
(C)	[CR][LF] S:530,70[CR][LF]		S:530,70
(C)	[CR][LF] S:630,70[CR][LF]		S:630,70

* [CR] and [LF] represent Carriage Return (0x0D) and Line Feed (0x0A) respectively.

9-3-2. Receiving Responses (Commands 1-6)

- **Timeout Waiting for Command Response from MFR**

Set the **timeout** period (maximum permitted time until its response returns from the MFR unit) to **1 second** for short message commands and to **5 seconds** for long message commands.

- **If Sending Commands Successively:**

- For "X:", "B:C", "P:" and "W:" commands, send the next command **after a prompt** returns.

- For "S?", "X?", "P?", "V?", "B:E" and "Z:" commands, send the next command **after a prompt and reply messages** return.

- For "S?" and "Z:" commands as well as "V?" and "B:E" commands after executing many preset commands, send the next command **after** having finished receiving **all strings** of reply messages.

Ex. 1)

Allows to send the next command when receiving a prompt.

Resends the previous command when the timeout period (5 seconds) have elapsed without reply after sending a command.

Ex. 2)

Allows to send the next command when receiving a prompt.

Resends the previous command when the timeout period (5 seconds) have elapsed without reply after sending a command.

Recognizes and uses "S" responses as tallies (crosspoint states).

Ex. 3)

Allows to send the next command when receiving a prompt.

Recognizes and uses "S" responses as tallies (crosspoint states).

Resends the previous command when the timeout period (5 seconds) have elapsed without reply after sending a command.

Sets the maximum number of continuous resendings, because crosspoints cannot be changed if they are locked or inhibited to change.

Ex. 4)

Allows to send the next command when receiving a prompt.

Resends the previous command when the timeout period (5 seconds) have elapsed without reply (echo) after sending a command.

Ex. 5)

Allows to send the next command when receiving a prompt.

● **Response Message Evaluation Example:**

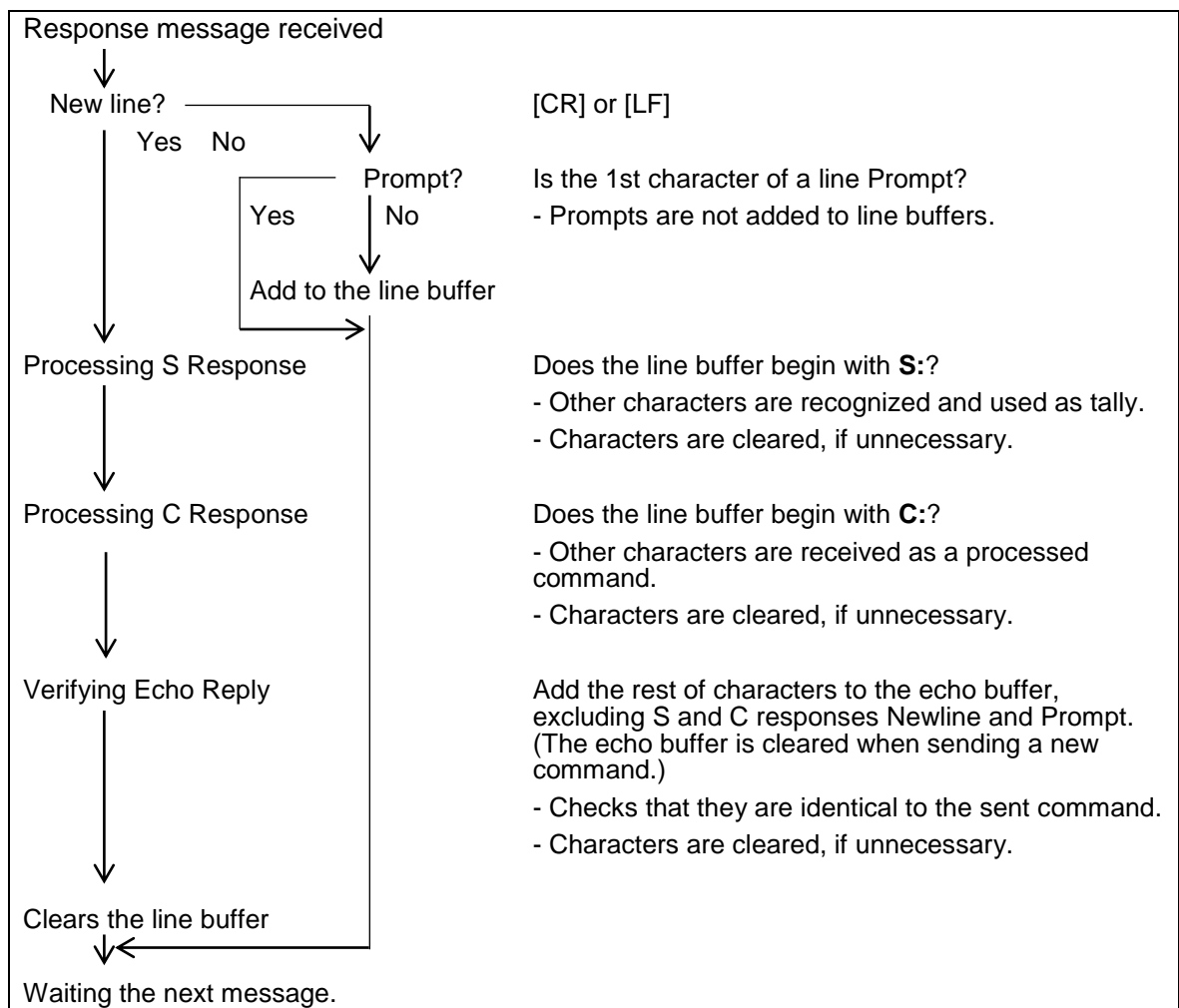

● **If Commands are Overlapped:**

Two or more commands are sent from different terminals (via serial or LAN interface, or Remote Control units), all command results (C and S responses) are sent to all these terminals from the MFR.

The following command examples shows how overlapped commands are processed.

Ex.) Assume that the following commands are overlapped:

Terminal 1 sent "@ X:0/2,4."

Terminal 2 sent "@ X:123456/30,70."

Message examples returned to Terminal 1

1-(A)	@ X:0/2,4[CR] [CR][LF]> [CR][LF]
1-(B)	C:0/2,4:IA[CR][LF] [CR][LF]
2-(B)	C:123456/30,70...S5:IA[CR][LF] [CR][LF]
1-(C)	S:02,4[CR][LF] [CR][LF]
2-(C)	S:130,70[CR][LF] [CR][LF]
2-(C)	S:230,70[CR][LF] [CR][LF]
2-(C)	S:330,70[CR][LF] [CR][LF]
2-(C)	S:430,70[CR][LF] [CR][LF]
2-(C)	S:530,70[CR][LF] [CR][LF]
2-(C)	S:630,70[CR][LF]

Terminal display

@ X:0/2,4
>
C:0/2,4:IA
C:123456/30,70...S5:IA
S:02,4
S:130,70
S:230,70
S:330,70
S:430,70
S:530,70
S:630,70

Message examples returned to Terminal 2

2-(A)	@ X:123456/30,70[CR] [CR][LF]> [CR][LF]
1-(B)	C:0/2,4:IA[CR][LF] [CR][LF]
2-(B)	C:123456/30,70...S5:IA[CR][LF] [CR][LF]
1-(C)	S:02,4[CR][LF] [CR][LF]
2-(C)	S:130,70[CR][LF] [CR][LF]
2-(C)	S:230,70[CR][LF] [CR][LF]
2-(C)	S:330,70[CR][LF] [CR][LF]
2-(C)	S:430,70[CR][LF] [CR][LF]
2-(C)	S:530,70[CR][LF] [CR][LF]
2-(C)	S:630,70[CR][LF]

Terminal display

@ X:123456/30,70
>
C:0/2,4:IA
C:123456/30,70...S5:IA
S:02,4
S:130,70
S:230,70
S:330,70
S:430,70
S:530,70
S:630,70

* C responses are sent before S responses in some cases.

9-3-3. Channel Name Request Commands (7)

K? Commands allow you to obtain Source and Destination names in ASCII and/or in Kanji set in the MFR Web-based Control menu.

Up to 32 channel names can be obtained per a single request.

Note that the number of request channels exceeds the system maximum size, no data will return for the exceeded channels.

▶ See the [Web-based Control: **SystemSize/LevelName** page].

◆ Command Format

Command	Command response
@[sp]K?<SorD><AorK>,<Ofset>	K:<SorD><AorK><No.>,<Dat>

Commands

BYTE No.	1	2	3	4	5	6	7	8-10	11
Command	@	[sp]	K	?	S	A	,	000-OFF	CR
					D	K		000-OFF	

Command response

BYTE No.	1	2	3	4	5	6	7-9	10	11-		
Response	CR	LF	K	:	S	A	000-OFF	,		CR	LF
					D	K	000-OFF				

Command Response	BYTE 5	<S or D> Select between S (Source) or D (Destination) S: Source, D: Destination
	BYTE 6	<A or K> Select A (Ascii) or K (Kanji) for names.
Command	BYTE8-10	<Offset> Specify the start number of channels. Source: 000-OFF, Destination: 000-OFF
Response	BYTE7-9	<No.> Indicates the channel number. Source: 000-OFF, Destination: 000-OFF
Response	BYTE11-	<Dat> Indicates the channel name in Ascii or Kanji using hex characters (max. 128 bytes). Character code for Ascii names: Ascii Character code for Kanji names: UTF-8
Command Response	CR	Carriage return
	LF	Line feed

◆ **Command Example 1: Requesting the Source Channel 1 Ascii Name**

➤ Web-based Control (Source Name menu)

➤ Terminal display

Command	@ K?SA,000
---------	------------

Response	@ K?SA,000	Echo
	K:SA000,5352432031	Ascii Name for Source Channel 1 is SRC 1.
	K:SA001,5352432032	Ascii Name for Source Channel 2 is SRC 2.
	K:SA002,5352432033	Ascii Name for Source Channel 3 is SRC 3.
	K:SA01F,5352433332	Ascii Name for Source Channel 32 is SRC32.
	>	Prompt

➤ Response details

K:	S	A	000,	53	52	43	20	31
	Source	ASCII	Channel 1	S	R	C	[sp]	1

◆ **Command Example 2: Requesting the Destination Channel 101 Kanji Name**

➤ Web-based Control (Destination Name menu)

➤ Terminal display

Command	@ K?DK,064
---------	------------

Response	@ K?DK,064	Echo
	K:DK064,E587BAE58A9BEFBC91EFBC90EFBC91	Kanji Name for Destination Channel 101 is 出力101.
	K:DK065,E587BAE58A9BEFBC91EFBC90EFBC92	Kanji Name for Destination Channel 102 is 出力102.
	K:DK066,E587BAE58A9BEFBC91EFBC90EFBC93	Kanji Name for Destination Channel 103 is 出力103.
	K:DK083,E587BAE58A9BEFBC91EFBC93EFBC92	Kanji Name for Destination Channel 132 is 出力132.
	>	Prompt

➤ Response details

K:	D	K	064,	E587BA	E58A9B	EFBC91	EFBC90	EFBC91
	Destination	Kanji	Channel 101	出	力	1	0	1

K:	D	K	065,	E587BA	E58A9B	EFBC91	EFBC90	EFBC92
	Destination	Kanji	Channel 102	出	力	1	0	2

◆ **Command Example 3: Requesting the Source Channel 65 Kanji Name**

➤ Web-based Control (Source Name menu)

➤ Terminal display

Command @ K?SK,040

Response	@ K?SK,040	Echo
	K:SK040,E382ABE383A1E383A9EFBC91	Kanji Name for Source Channel 65 is カメラ1.
	K:SK041,E382ABE383A1E383A9EFBC92	Kanji Name for Source Channel 66 is カメラ2.
	K:SK042,E382ABE383A1E383A9EFBC93	Kanji Name for Source Channel 67 is カメラ3.
	K:SK043,E382ABE383A1E383A9EFBC94	Kanji Name for Source Channel 68 is カメラ4.
	K:SK044,	Kanji Name for Source Channel 69 is empty.
	K:SK045,	Kanji Name for Source Channel 70 is empty.
	K:SK046,	Kanji Name for Source Channel 71 is empty.
	K:SK047,E382B5E383BCE38390E383BCEFBCA1	Kanji Name for Source Channel 72 is サーバーA.
	K:SK05F,	Kanji Name for Source Channel 96 is empty.
	>	Prompt

➤ Response details

K:	S	K	040,	E382AB	E383A1	E383A9	EFBC91
	Source	Kanji	Channel 68	カ	メ	ラ	1

K:	S	K	044,	
	Source	Kanji	Channel 69	(Empty)

K:	S	K	047,	E382B5	E383BC	E38390	E383BC	EFBCA1
	Source	Kanji	Channel 72	サ	—	バ	—	A

9-3-4. CPU Status Request Command (8)

This command allows you to indicate which CPU is active in the MFR-3000.

◆ **Command format**

Control command	Command response
@[sp]A?	@[sp]A:<ID>

Control command

BYTE No.	1	2	3	4
Command	@	[sp]	A	?

Command response

BYTE No.	1	2	3	4	5
Response	@	[sp]	A	:	<ID>

<ID>: Unit ID number (01-FE)

◆ **Command Response**

There are two response types whether the CPU is active or passive state.

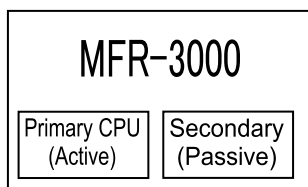

If the MFR-3000 CPU is active:

Response	@ A?	Echo
	A:A	Unit ID number is 10 (0x0A)
		New line
	>	Prompt

9-3-5. Destination Lock Status Request Command (9)

This command (W?) allows you to indicate the destination lock status in the MFR system.

◆ Command format

Control command	Command response
@[sp]W?<Lvl>,<Dest>	@[sp]W!<Dest>,<ID> ,

Control command

BYTE No.	1	2	3	4	5	6	7	8
Command	@	[sp]	W	?	<Lvl>	,	<Dest>	CR

<Dest>: Destination channel number

Command response

BYTE No.	1	2	3	4	5	6	7	8	9	10	11	12
Response	CR	LF	W	!	<Lvl>	<Dest>	,	<ID>	,	0	CR	LF
										1		
										2		

◆ Command Response Examples

If Destination 1 is locked by ID10 Unit using LOCK, Destination 1 status returns as shown below:

Response	@ W?0,0	Echo
	W!00,A,1	Dest 1 is locked by ID10 (0x0A) unit using LOCK ALL.
		CR LF
	>	Prompt

If Destination 2 is locked by ID11 Unit using LOCK OTHER, Destination 2 status returns as shown below:

Response	@ W?0,1	Echo
	W!01,B,2	Dest 2 is locked by ID11 (0x0B) unit using LOCK OTHER.
		CR LF
	>	Prompt

If Destination 3 is not locked, Destination 3 status returns as shown below:

Response	@ W?0,2	Echo
	W!02,0,0	Dest 3 is not locked.
		CR LF
	>	Prompt

10. Troubleshooting

If any of the following problems occur during operation of your MFR-3000, proceed as indicated below to see if the problem can be corrected before assuming a unit malfunction has occurred.

IMPORTANT

If the problem cannot be corrected by performing the procedures below, turn the unit off and then on again. If this still does not correct the problem, contact your dealer.

Problem	Check	Remedy
No image output.	Are there signal inputs to the video input connectors?	Input video signals to the video input connectors.
	Are cables properly connected for the signal inputs?	Connect cables properly.
	Is the crosspoint set properly?	Set crosspoints properly.
Unable to control using the remote control panel.	Is the LAN cable properly connected?	Properly connect the LAN cable.
	Is the RU Info page in the Web-based Control indicating NG?	Check the item that is indicated as NG. However, if the Voltage is indicated as NG, contact your FOR-A agent. See the Web-based Control Operation Manual for details.
The secondary CPU is active.	Are both MFR-LAN 1 and MFR-LAN 2 properly connected to the network? (Check the cable and Ethernet hub connections.)	Connect both MFR-LAN 1 and MFR-LAN 2 to the network correctly.
	If network connections are properly made, turn unit power OFF then ON again.	Consult your FOR-A reseller if the secondary CPU is still active after restarting
The text color has changed from the original color.	Button displays may be deteriorated over time.	Refer to Sec. 10-1 to fine-tune colors.

10-1. Tuning the Text Color on Remote Unit Buttons

MFR-18RU/39RU/16RUTA/39RUA/18RUA units allow you to adjust the color of NAME DISPLAY

10-1-1. MFR-18RU/39RU Color Tuning Procedure

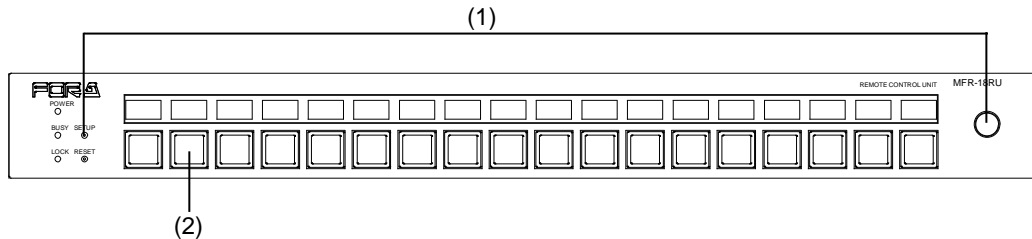

- (1) Press and hold **CONTROL**, then press the **SETUP** button for more than 5 seconds. All NAME DISPLAY text will turn to white.
- (2) Press a button to be adjusted.

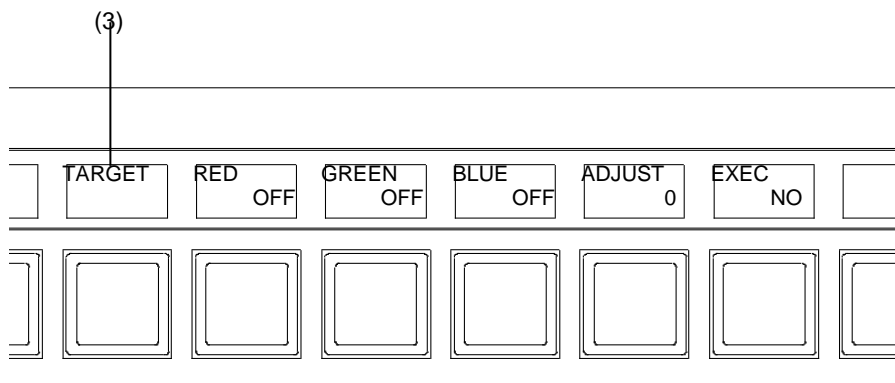

- (3) The **TARGET** will appear and blink above the button and **RED**, **GREEN**, **BLUE**, **ADJUST** and **EXEC** are also displayed.
- (4) To set **RED**, **GREEN** or **BLUE** to **ON**, turn **CONTROL** to select **RED**, **GREEN** or **BLUE**, then press **CONTROL** to turn it to **ON**.
- (5) Press **CONTROL** to select **ADJUST**, then turn **CONTROL** to adjust the selected color component(s) (RED, GREEN and/or BLUE).
- (6) After the button color adjustment is complete, press **CONTROL** to move to **EXEC**. Turn **CONTROL** to select **YES**, then press **CONTROL** to execute the setting.
- (7) The **TARGET** will blink above the button. Pressing another button allows you to apply the set color to the button. The **COPY** will appear above the button.
- (8) After applying the color to all buttons, press **SETUP** to complete the color adjustment.

10-1-2. MFR-16RUTA/39RUA/18RUA Color Tuning Procedure

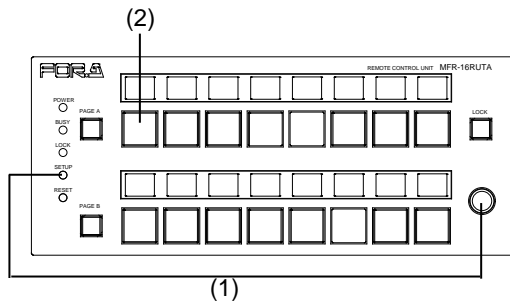

- (1) Press and hold **CONTROL**, then press the **SETUP** button for more than 5 seconds. All NAME DISPLAY text will turn to white.
- (2) Press a button to be adjusted.

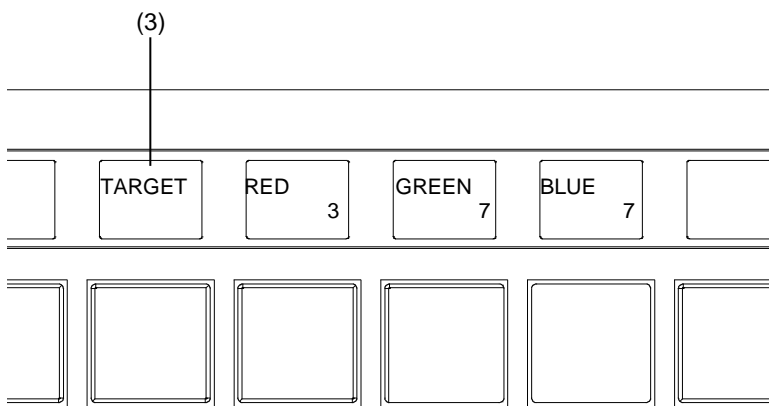

- (3) The **TARGET** will appear and blink above the button. **RED**, **GREEN** and **BLUE** are also displayed.
- (4) To adjust the target button color using **RED**, **GREEN** and **BLUE**, press **CONTROL** to select **RED**, **GREEN** or **BLUE**, then turn **CONTROL** to change its value.

Setting range: RED: 0-3, GREEN and BLUE: 0-7

- (5) To adjust another button color, repeat steps from (2) to (4)
- (6) All button color settings are finished, press **SETUP**.

11. Specifications and Dimensions

11-1. Unit Specifications

11-1-1. MFR-3000

Video Formats

12G-SDI	2160/59.94p, 2160/50p
3G-SDI	1080/60p, 1080/59.94p, 1080/50p
HD-SDI	1080/60i, 1080/59.94i, 1080/50i, 1080/30p, 1080/30PsF, 1080/29.97p, 1080/29.97PsF, 1080/23.98p, 1080/23.98PsF, 1080/25p, 1080/25PsF, 1080/24PsF, 1080/24p, 720/60p, 720/59.94p, 720/50p
SD-SDI	525/60, 625/50

Matrix Size

Min. 8 x 8 to Max. 64 x 64
Number of input slots: 8
Number of output slots: 8
(Expandable on a 8-channel basis)

Video Input

MFR-8SDI

SDI Input Card (Max. 8 cards)
- BNC x 8
Compliant with the following (75Ω BNC)
- SMPTE424M (3G-SDI)
- SMPTE292M (HD-SDI)
- SMPTE259M (SD-SDI)
- DVB-ASI

Cable Equalization

3G/HD-SDI: 100 m (5C-FB cable)
SD-SDI: 200 m (5C-2V cable)

MFR-8SDIGB

SDI Input Card (Max. 8 cards)
- BNC x 2 (12G-SDI or 3G-SDI)
- BNC x 6 (3G-SDI)
Compliant with the following standards (75Ω BNC)
- SMPTE ST 2082-10 (12G-SDI)
- SMPTE ST 425-5 (Quad Link 3G-SDI)
I/O delay selection
Delay (H) (0.3H-1H), 1 frame, 1 frame+ Delay (H)

Video Output

MFR-8SDO

SDI Output Card (Max. 8 cards)
- BNC x 8
Compliant with the following (75Ω BNC) (Auto reclocking)
- SMPTE 424M (2.97 Gbps, 2.97/1.001 Gbps)
- SMPTE292M (1.485 Gbps, 1.485/1.001 Gbps)
- SMPTE259M (270 Mbps)
- DVB-ASI

MFR-8SDOGB

SDI Output Card (Max. 8 cards)
- BNC x 2 (12G-SDI or 3G-SDI)
- BNC x 6 (3G-SDI)
Compliant with the following (75Ω BNC)
- SMPTE ST 2082-10 (12G-SDI)
- SMPTE ST 425-5 (Quad Link 3G-SDI)
I/O delay selection
Delay (H) (0.3H-1H), 1 frame, 1 frame+ Delay (H)

Audio Input	
MFR-8AAI	Analog Audio Input Card with A/D converter (Max. 8 cards) - 25-pin D-sub (female) x 2 (8 stereo pairs, 16 channels) - Balanced or unbalanced, 600 ohm or high impedance - Sampling frequency: 48kHz
MFR-8AESI	AES/EBU Audio Input Card (Max. 8 cards) - BNC x 8 (8 stereo pairs, 16 channels) - 75 ohm, BNC
Audio Output	
MFR-8AAO	Analog Audio Output Card with D/A converter (Max. 8 cards) - 25-pin D-sub (female) x 2 (8 stereo pairs, 16 channels), - Balanced or unbalanced, less than 100Ω, 48 kHz
MFR-8AESO	AES/EBU Audio Output Card (Max. 8 cards) - BNC x 8 (8 stereo pairs, 16 channels) - 75 ohm BNC
Multiviewer	
MFR-16MV	16 SDI output card with multiviewer function (Up to 4 cards) - 2 slots required per card - BNC x 16 - 75 ohm BNC
Reference Input	BB: 0.429 Vp-p (NTSC)/0.45 Vp-p (PAL) or Tri-level Sync: 0.6 Vp-p 75Ω BNC x 1, loop-through (Terminate with 75Ω terminator, if unused.)
Interfaces	
MFR-LAN	10/100/1000 Base-T, RJ-45 x 2 (For connecting up to 128 RU/GPI units.) (Second LAN port used in redundant CPU configuration)
PC-LAN	10/100 Base-TX, RJ-45 x 1 (for PC operation)
SERIAL	RS-232C/RS-422 (Internal switch), 9-pin D-sub (male) x 1
ALARM	9-pin D-sub (female) x 1 (Input: Reset, Output: Power alarm, fan alarm, crosspoint error, CPU changeover and secondary CPU error)
Temperature	0°C to 40°C
Humidity	30% to 85% (no condensation)
Power	100 VAC to 240 VAC ±10%, 50/60Hz IN x 2 (MFR-30PS required for redundant power configuration)
Consumption	When performing 64 x 64 SDI signal routing: 150 VA (145W) at 100 - 120 V AC, 198 VA (136W) at 220 - 240 V AC
	* The power consumption may increase up to the following maximum value if performing different signal routing such as video and audio routing. 100 V AC to 120 V AC: 671 VA (661 W), 200 V AC to 240 V AC: 608 VA (510 W)
Dimensions	482 (W) x 177 (H) x 350 (D) mm EIA 4RU
Weight	18 kg (with full options)
Consumables (24 hours in room temperature)	Power supply unit: Replace every 5 years FAN 1 & 2 (rear) : P-1529 Replace every 4 years FAN 3 & 4 (front) : P-1567 Replace every 4 years FAN 3 & 4 (front) :P-1528 Replace every 4 years (Firmware version less than 1.81) MFR-16MV button battery: CR2032. Replace every 5 years

11-1-2. MFR-30FP

Buttons/Colors	64 buttons (1 color: green), user assignable Menu display (TFT, 320 x 240) x 1 Menu selection button (1 color: green) x 5 CANCEL button x 1 LOCK control button (1 color: green) x 1 Rotary selector x 1
Temperature	0°C to 40°C
Humidity	30% to 85% (no condensation)

11-1-3. MFR-39RUA

Buttons/Colors	39 buttons (OLED buttons, 7-color) Displayed in each button (Max. 7 characters x 2 lines) 6 buttons (3 colors: red/green/orange), user assignable Current DEST button, current SRC button, current PAGE display x 2, Rotary selector
Number of Connections	Max. 128 (including Main, Remote and GPI units)
Interfaces	
MFR-LAN	10/100BASE-TX RJ-45 x 1 (For connection to MU. A network hub required for multiple unit configuration.)
SERVICE	RS-232C 9-pin D-sub (male) x 1 (for maintenance)
Temperature	0°C to 40°C
Humidity	30% to 85% (no condensation)
Power	+12 V DC Pin-connector x 2 (redundant power supply as standard)
Consumption	100 V AC to 120 V AC: 19 VA (9 W), 200 V AC to 240 V AC: 24 VA (9 W)
Dimensions	430(W) x 88(H) x 42(D) mm EIA 2 RU
Weight	3 kg
Consumables	AC adaptor: Replace every 5 years.

11-1-4. MFR-39RU

Buttons/Colors	39 buttons (LED buttons, 7-color), user assignable Displayed in each button (Max. 7 characters x 2 lines) 10 buttons (3 colors: red/green/orange), user assignable Menu display x 1 (Max. 23 characters x 2 lines) with Rotary selector
Number of connections	Max. 128 (including Main, Remote and GPI units)
Interfaces	
MFR-LAN	10/100BASE-TX RJ-45 x 1 (For connection to MU. A network hub required for multiple unit configuration.)
SERVICE	RS-232C 9-pin D-sub (male) x 1 (for maintenance)
Temperature	0°C to 40°C
Humidity	30% to 85% (no condensation)
Power	+12 V DC Pin-connector x 2 (redundant power supply as standard)
Consumption	100 V AC to 120 V AC: 17 VA (9 W), 200 V AC to 240 V AC: 22 VA (11 W)
Dimensions	430(W) x 88(H) x 44(D) mm EIA 2 RU
Weight	3 kg
Consumables	AC adaptor: Replace every 5 years.

11-1-5. MFR-40RU

Buttons/Colors	40 buttons (3 colors: red/green/orange), user assignable
Number of connections	Max. 128 units (including Main, Remote and GPI units)
Interfaces	
MFR-LAN	10/100BASE-TX RJ-45 x 1 (For connection to MU. A network hub required for multiple unit configuration.)
SERVICE	RS-232C 9-pin D-sub (male) x 1 (for maintenance)
Temperature	0°C to 40°C
Humidity	30% to 85% (no condensation)
Power	+12 VDC Pin-connector x 2 (redundant power supply as standard)
Consumption	100 V AC to 120 V AC: 10 VA (5 W), 200 V AC to 240 V AC: 15 VA (7 W)
Dimensions	430(W) x 44(H) x 42(D) mm EIA 1 RU
Weight	2 kg
Consumables	AC adaptor: Replace every 5 years.

11-1-6. MFR-18RUA

Buttons/Colors	18 buttons (3 colors: red/green/orange), user assignable OLED display x 18 (Max. 7 characters x 2 lines, Displayed above each button) with Rotary selector
Number of Connection	Max. 128 (including Main, Remote and GPI units)
Interfaces	
MFR-LAN	10/100BASE-TX RJ-45 x 1 (For connection to MU. A network hub required for multiple unit configuration.)
SERVICE	RS-232C 9-pin D-sub (male) x 1 (for maintenance)
Temperature	0°C to 40°C
Humidity	30% to 85% (no condensation)
Power	+12 V DC Pin-connector x 2 (redundant power supply as standard)
Consumption	100 V AC to 120 V AC: 14 VA (6 W), 200 V AC to 240 V AC: 18 VA (6 W)
Dimensions	430(W) x 44(H) x 42(D) mm EIA 1 RU
Weight	2 kg
Consumables	AC adaptor: Replace every 5 years.

11-1-7. MFR-18RU

Buttons/Colors	18 buttons (3 colors: red/green/orange), user assignable LCD display x 18 (Max. 7 characters x 2 lines, Displayed above each button) with Rotary selector
Number of connections	Max. 128 (including Main, Remote and GPI units)
Interfaces	
MFR-LAN	10/100BASE-TX RJ-45 x 1 (For connection to MU. A network hub required for multiple unit configuration.)
SERVICE	RS-232C 9-pin D-sub (male) x 1 (for maintenance)
Temperature	0°C to 40°C
Humidity	30% to 85% (no condensation)
Power	+12 V DC Pin-connector x 2 (redundant power supply as standard)
Consumption	100 V AC to 120 V AC: 12 VA (6 W), 200 V AC to 240 V AC: 18 VA (8 W)
Dimensions	430(W) x 44(H) x 42(D) mm EIA 1 RU
Weight	2 kg
Consumables	AC adaptor: Replace every 5 years.

11-1-8. MFR-16RU/16RUD

Buttons/Color	16 buttons (1 color: green), user assignable Menu Display (Max. 16 characters x 2 lines) (MFR-16RUD only)
Number of connections	Max. 128 (including Main, Remote and GPI units)
Interfaces	
MFR-LAN	10/100BASE-TX RJ-45 x 1 (For connection to MU. A network hub required for multiple unit configuration.)
Temperature	0°C to 40°C
Humidity	30% to 85% (no condensation)
Power	+12 V DC Pin-connector x 1
Consumption	MFR-16RU: 100 V AC to 120 V AC: 7 VA (3 W), 200 V AC to 240 V AC: 11 VA (4 W) MFR-16RUD: 100 V AC to 120 V AC: 8 VA (3 W), 200 V AC to 240 V AC: 11 VA (4 W)
Dimensions	430(W) x 44(H) x 34 (D) mm EIA 1 RU
Weight	1 kg
Consumables	AC adaptor: Replace every 5 years.

11-1-9. MFR-16RUTA

Buttons/Color	16 buttons (3 colors: red/green/orange), user assignable OLED display x 16 (Max. 7 characters x 2 lines, Displayed above each button) PAGE control button (lit orange) x 2 LOCK control button (lit orange) x 1 Rotary selector x 1
Number of connections	Max. 128 (including Main, Remote and GPI units)
Interfaces	
MFR-LAN	10/100BASE-TX RJ-45 x 1 (For connection to MU. A network hub required for multiple unit configuration.)
Temperature	0°C to 40°C
Humidity	30% to 85% (no condensation)
Power	+12 V DC Pin-connector x 1
Consumption	100 V AC to 120 V AC: 12VA (5W), 200 V AC to 240 V AC: 15VA (6W)
Dimensions	215(W) x 88(H) x 43(D) mm EIA 2 RU, half-rack size
Weight	1 kg
Consumables	AC adaptor: Replace every 5 years.

11-1-10. MFR-16RUW

Buttons/Color	18 buttons (1 color: green), user assignable
Number of connections	Max. 128 (including Main, Remote and GPI units)
Interfaces	
MFR-LAN	10/100BASE-TX RJ-45 x 1 (For connection to MU. A network hub required for multiple unit configuration.)
Temperature	0°C to 40°C
Humidity	30% to 85% (no condensation)
Power	+12 VDC Pin-connector x 1
Consumption	100 V AC to 120 V AC: 8 VA (3 W), 200 V AC to 240 V AC: 11 VA (3 W)
Dimensions	480(W) x 44(H) x 27 (D) mm EIA 1 RU
Weight	1 kg
Consumables	AC adaptor: Replace every 5 years.

11-1-11. MFR-32RUW

Buttons/Color	34 buttons (1 color: green), user assignable
Number of connections	Max. 128 (including Main, Remote and GPI units)
Interfaces	
MFR-LAN	10/100BASE-TX RJ-45 x 1 (For connection to MU. A network hub required for multiple unit configuration.)
Temperature	0°C to 40°C
Humidity	30% to 85% (no condensation)
Power	+12 VDC Pin-connector x 1
Consumption	100 V AC to 120 V AC: 10 VA (4 W), 200 V AC to 240 V AC: 13 VA (4 W)
Dimensions	480(W) x 44(H) x 27 (D) mm EIA 1 RU
Weight	1 kg
Consumables	AC adaptor: Replace every 5 years.

11-1-12. MFR-64RUW

Buttons/Color	68 buttons (1 color: green), user assignable
Number of connections	Max. 128 (including Main, Remote and GPI units)
Interfaces	
MFR-LAN	10/100BASE-TX RJ-45 x 1 (For connection to MU. A network hub required for multiple unit configuration.)
Temperature	0°C to 40°C
Humidity	30% to 85% (no condensation)
Power	+12 VDC Pin-connector x 1
Consumption	100 V AC to 120 V AC: 15 VA (7 W), 200 V AC to 240 V AC: 20 VA (8 W)
Dimensions	480(W) x 88(H) x 27(D) mm EIA2RU
Weight	1.5 kg
Consumables	AC adaptor: Replace every 5 years.

11-1-13. MFR-GPI

Number of connections	Max. 128 (including Main, Remote and GPI units)
Interface	
MFR-LAN	10/100BASE-TX RJ-45 x 1 (Ethernet hub is needed for Main and multiple unit connections.)
SERVICE	RS-232C: 9-pin D-sub (male) x 1 (for maintenance)
GPI IN	37-pin D-sub (female) x 4
/TALLY OUT	128-input/output (user assignable)
SERIAL 1-4	RS-232C/422 (selectable): 9-pin D-sub (male) x 4
Temperature	0°C to 40°C
Humidity	30% to 85% (no condensation)
Power	+12VDC pin connector x 2 (redundant power supply in standard configuration)
Power Consumption	100 V AC to 120 V AC: 8 VA (4 W) 200 V AC to 240 V AC: 13 VA (6 W)
Dimensions	430(W) x 44(H) x 110(D) mm EIA 1 RU
Weight	2 kg
Consumables	AC adaptor: Replace every 5 years

11-1-14. MFR-TALM

Number of connections	Max. 128 (including Main, Remote and GPI units)
Interface	
MFR-LAN	10/100/1000BASE-T RJ-45 x 1 (Ethernet hub is required for Main and multiple unit connections.)
PC-LAN	10/100BASE-TX RJ-45 x 1 (for PC or other external devices)
GPI IN	37-pin D-sub (female) x 1
/TALLY OUT	32-input/output (user assignable)
RS-422	9-pin D-sub (male) x 4
Temperature	0°C to 40°C
Humidity	30% to 85% (no condensation)
Power	+12 V DC pin connector x 2 (redundant power supplies in standard configuration)
Power Consumption	100 V AC to 120 V AC: 17 VA (9 W) 200 V AC to 240 V AC: 20 VA (9 W)
Dimensions	212(W) x 44(H) x 161(D) mm EIA 1 RU half size
Weight	2 kg
Consumables	AC adaptor: Replace every 5 years

11-2. External Dimensions

11-2-1. MFR-3000

(All dimensions in mm.)

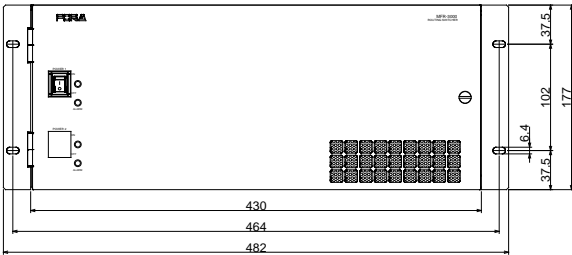
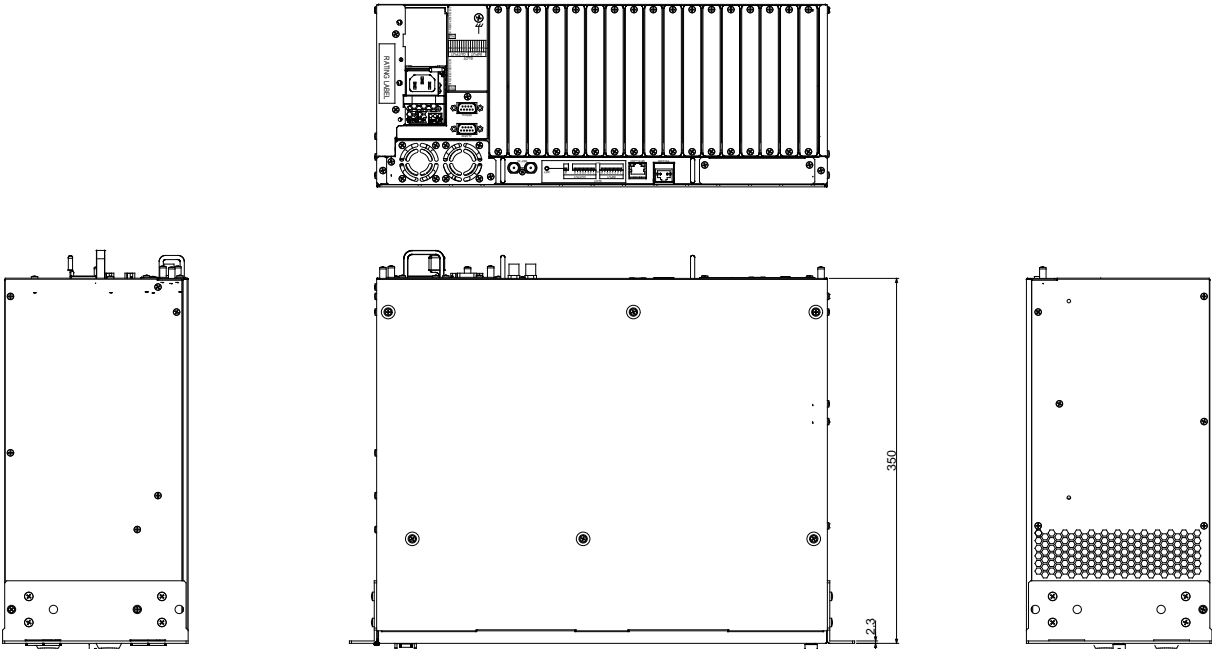

◆ When an MFR-30FP option installed:

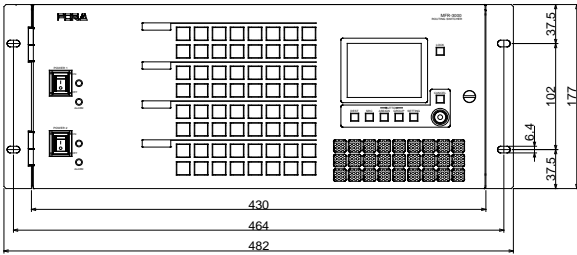

11-2-2. MFR-39RUA

(All dimensions in mm.)

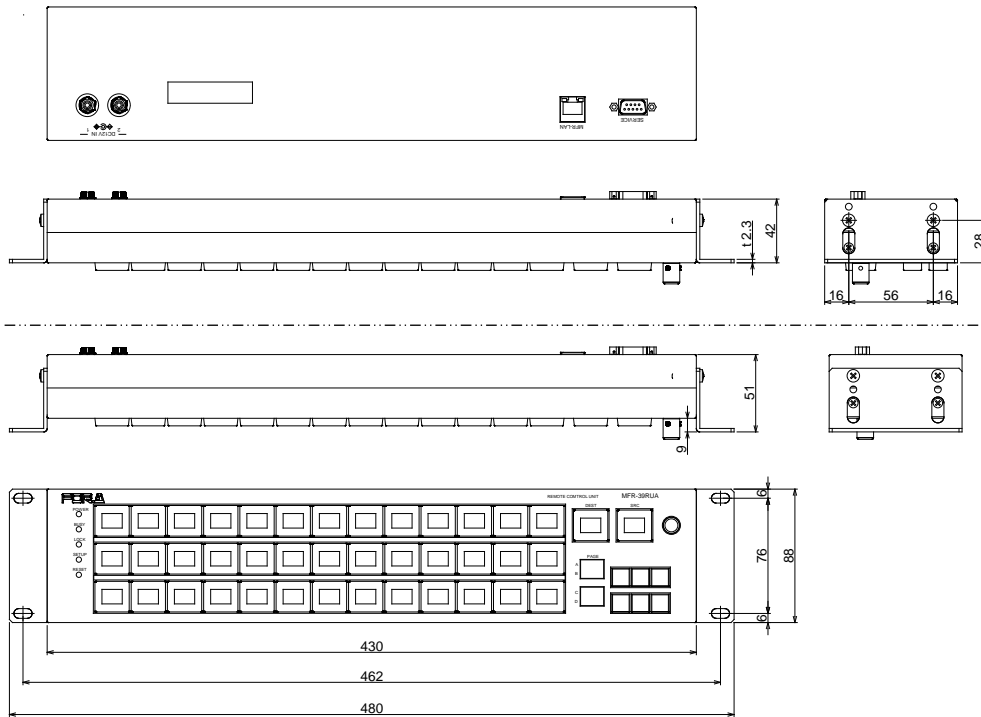

* The panel buttons can be fitted within the rack by sliding the rack ears forward to attach as shown in the bottom figure above.

11-2-3. MFR-39RU

(All dimensions in mm.)

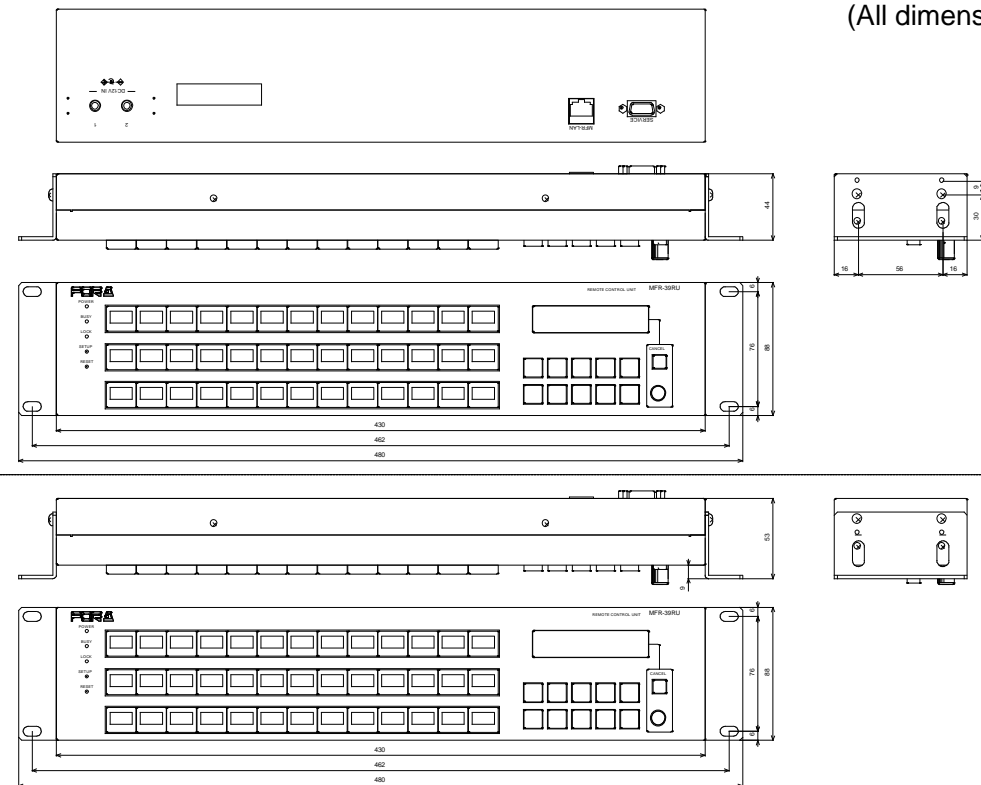

* The panel buttons can be fitted within the rack by sliding the rack ears forward to attach as shown in the bottom figure above.

11-2-4. MFR-40RU

(All dimensions in mm.)

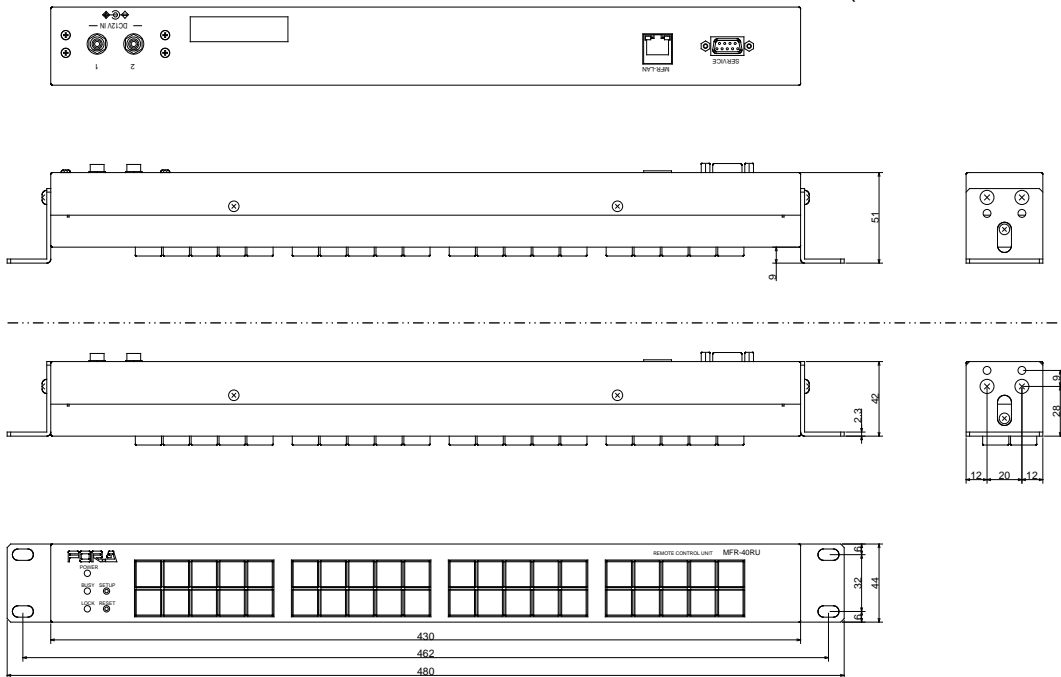

* The panel buttons can be fitted within the rack by sliding the rack ears forward to attach as shown in the bottom figure above.

11-2-5. MFR-18RUA

(All dimensions in mm.)

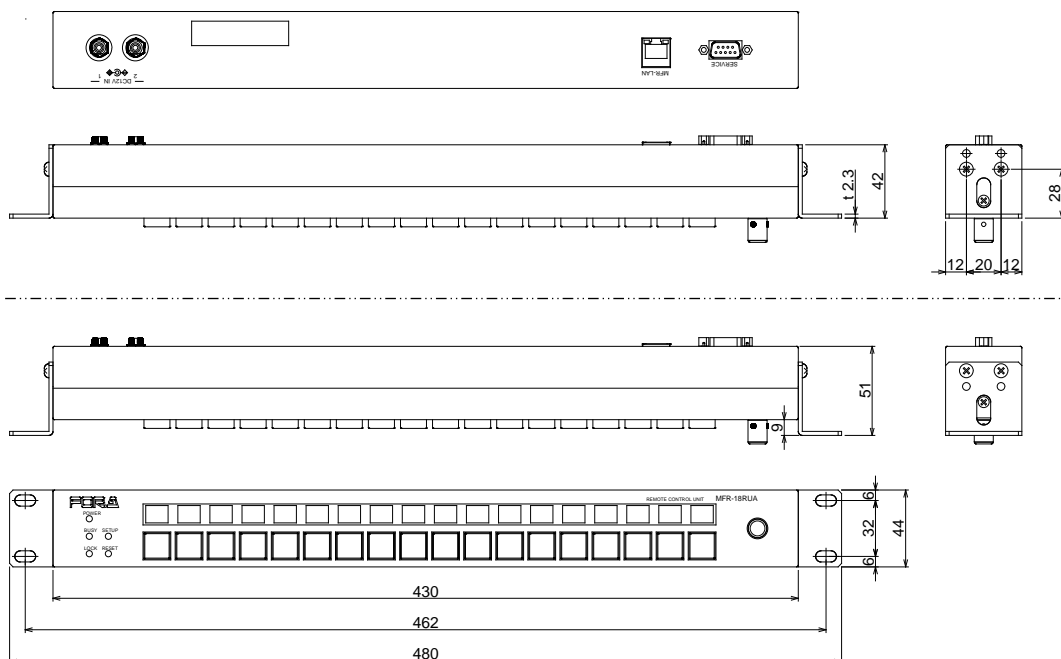

* The panel buttons can be fitted within the rack by sliding the rack ears forward to attach as shown in the bottom figure above.

11-2-6. MFR-18RU

(All dimensions in mm.)

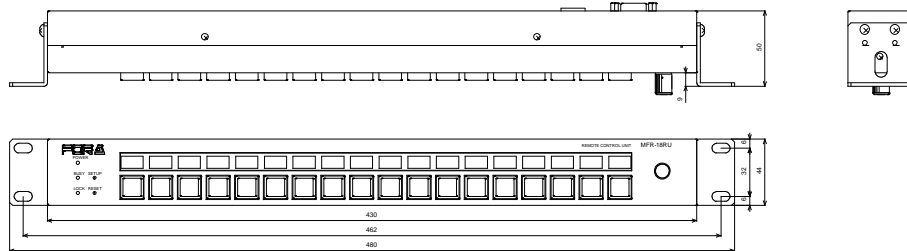
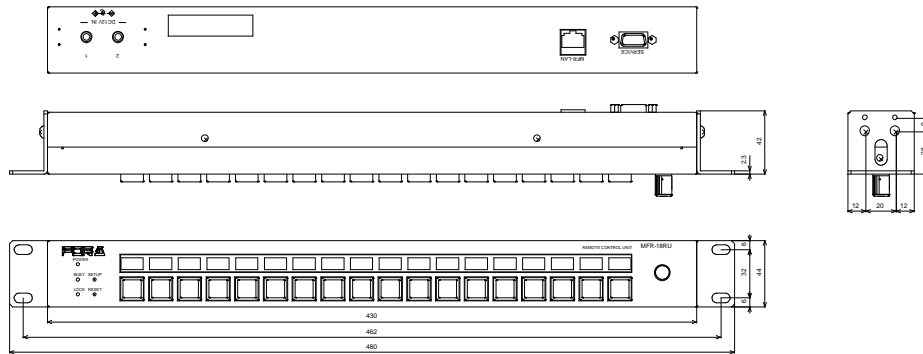

- * The panel buttons can be fitted within the rack by sliding the rack ears forward to attach as shown in the bottom figure above.

11-2-7. MFR-16RU

(All dimensions in mm.)

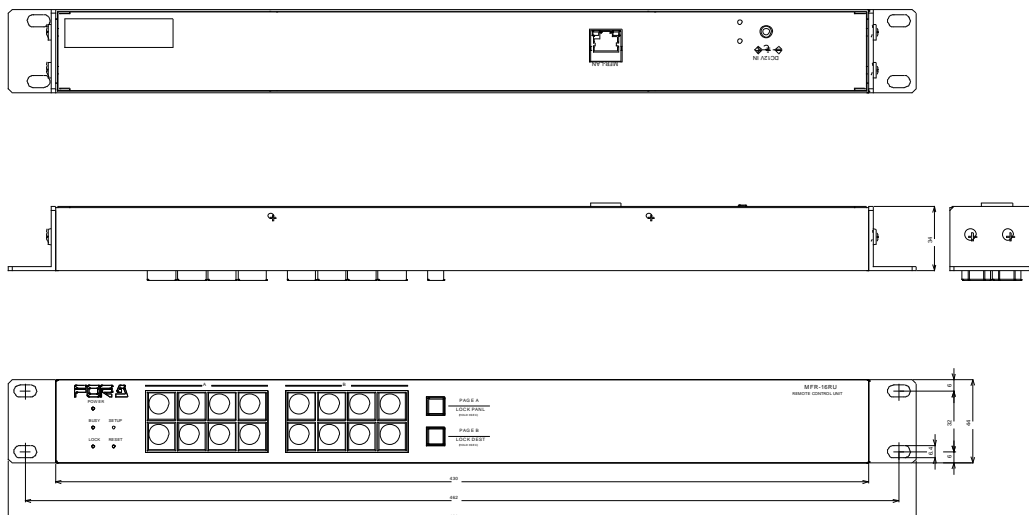

11-2-8. MFR-16RUD

(All dimensions in mm.)

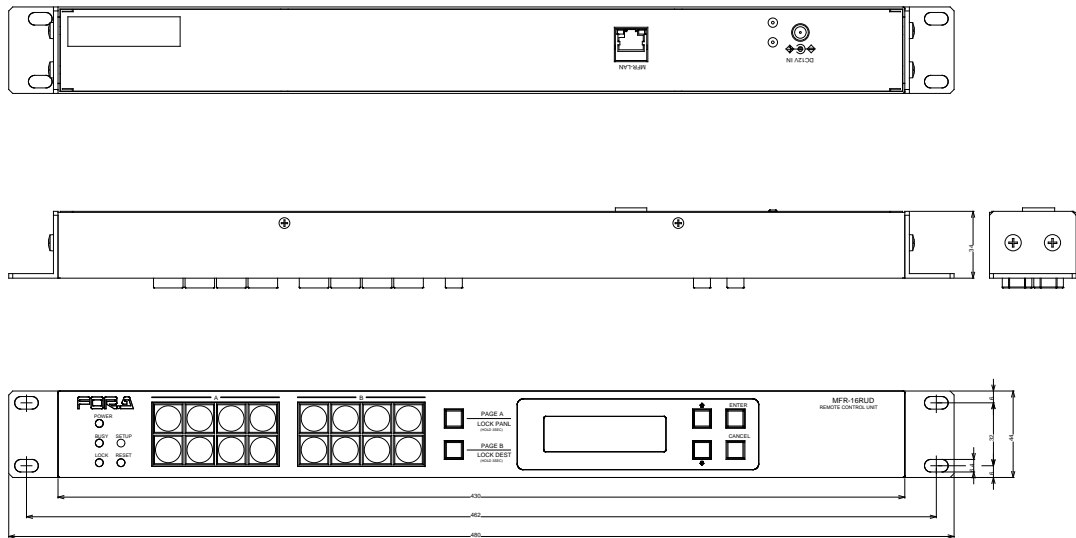

11-2-9. MFR-16RUTA

(All dimensions in mm.)

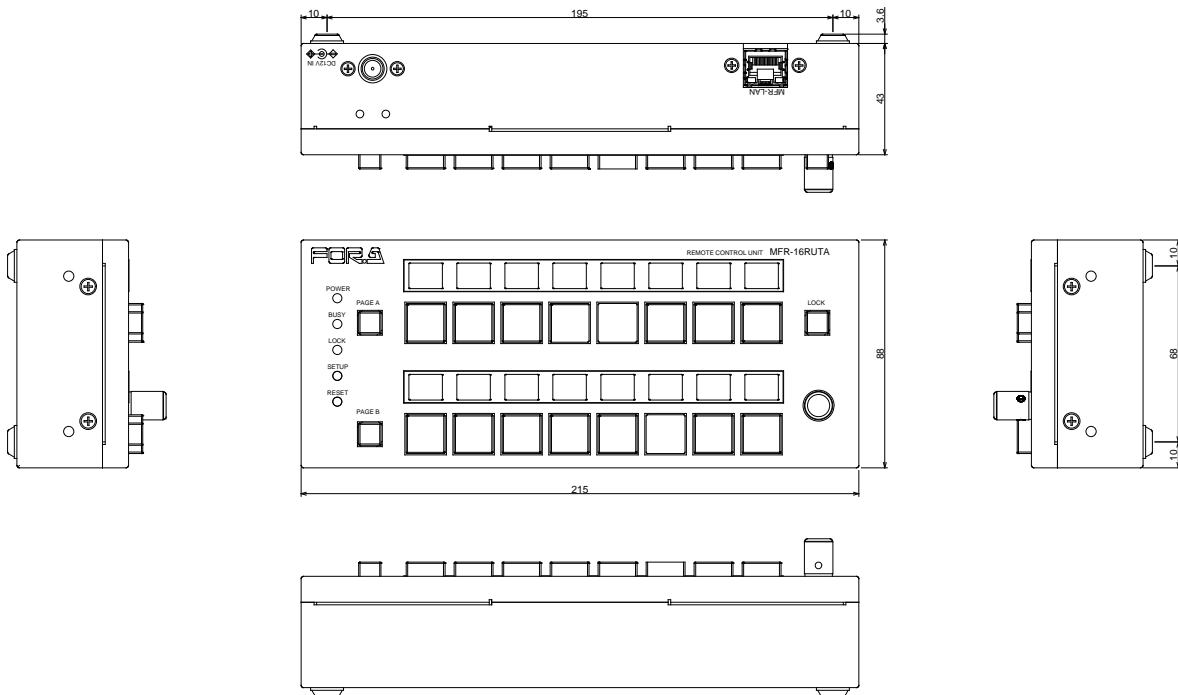

11-2-10. MFR-16RUW

(All dimensions in mm.)

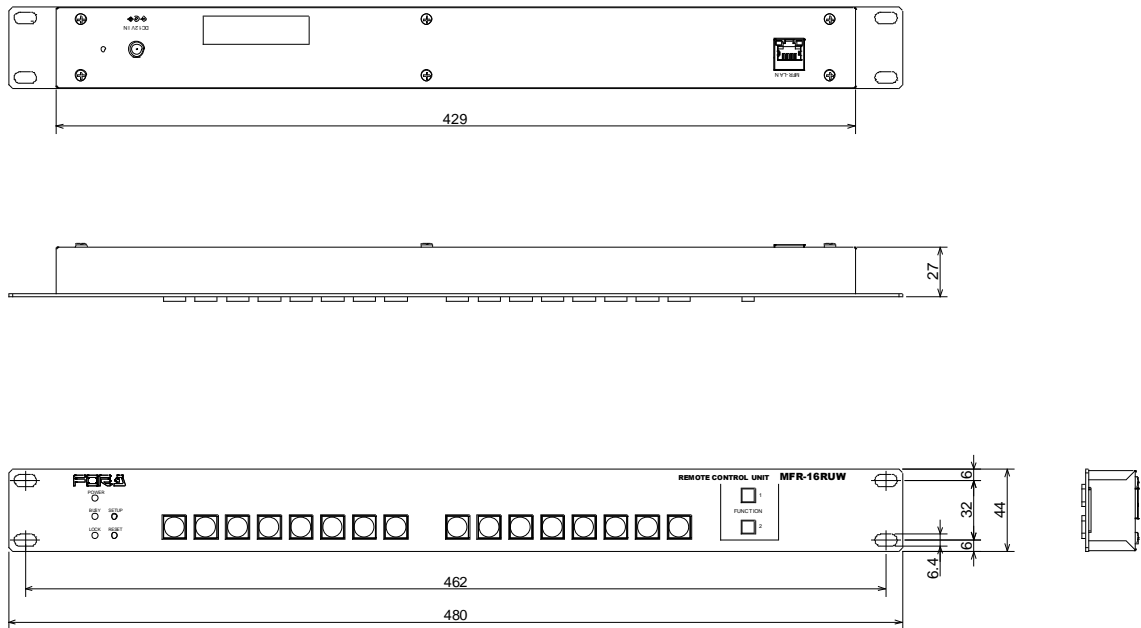

11-2-11. MFR-32RUW

(All dimensions in mm.)

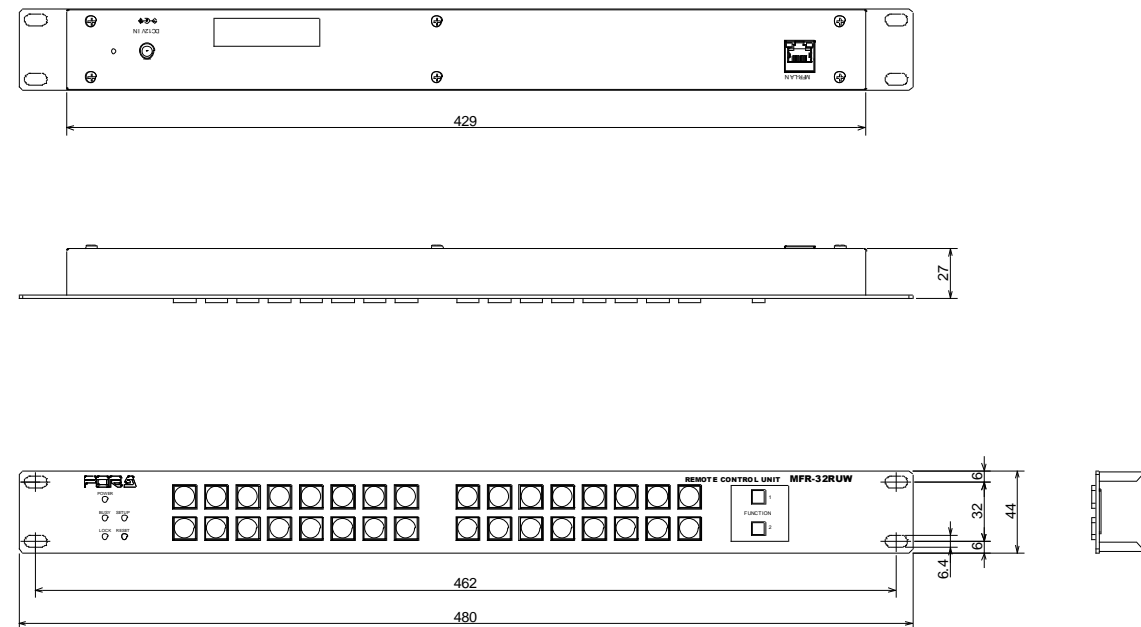

11-2-12. MFR-64RUW

(All dimensions in mm.)

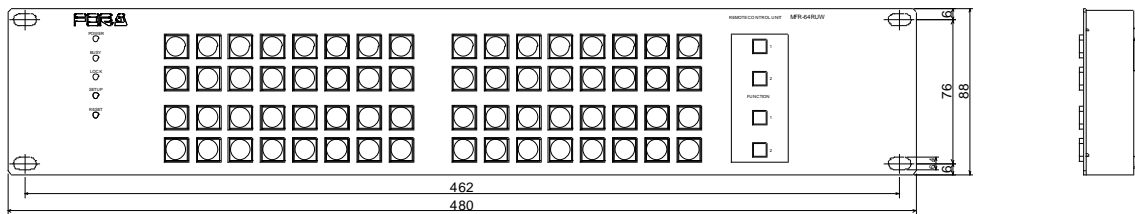
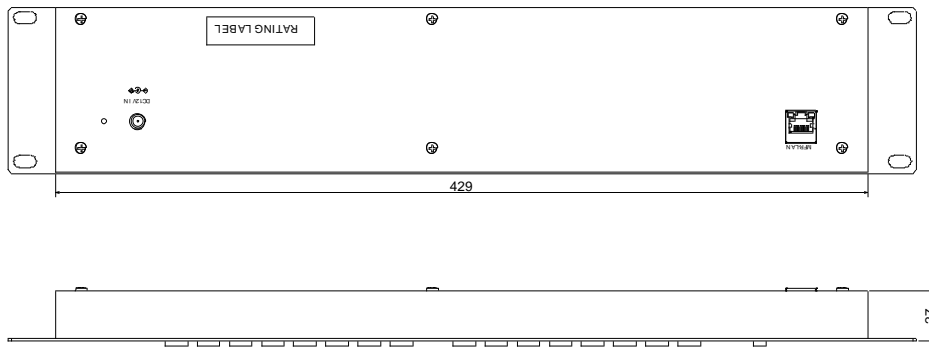

11-2-13. MFR-GPI

(All dimensions in mm.)

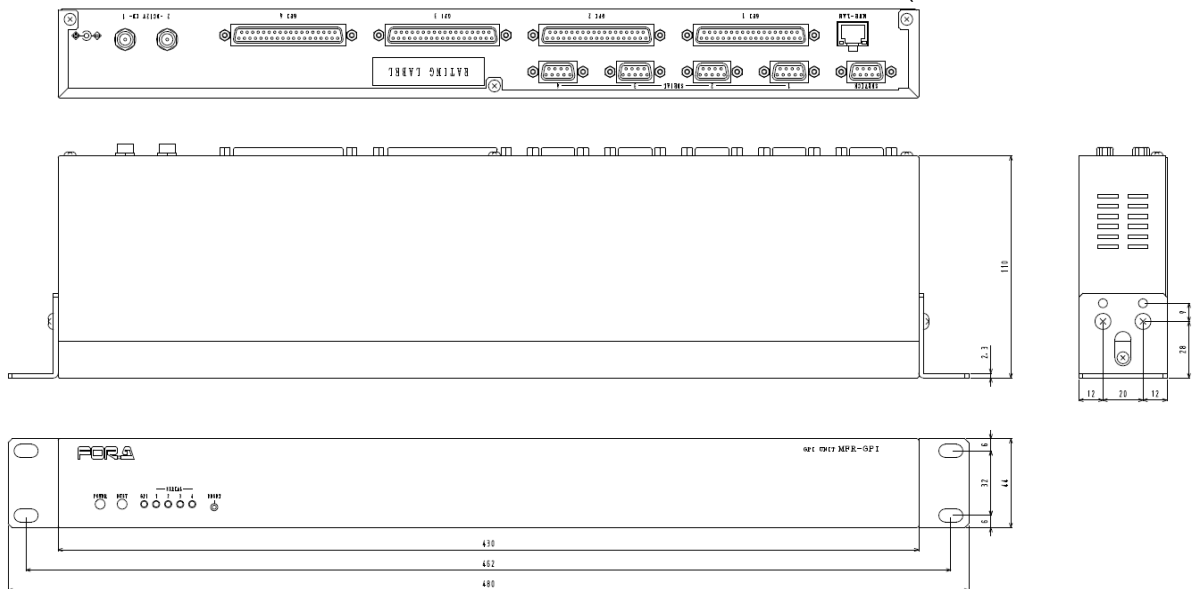

11-2-14. MFR-TALM

(All dimensions in mm.)

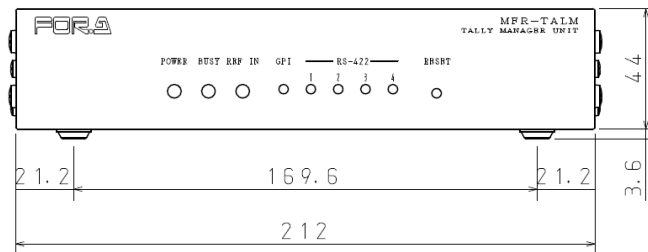
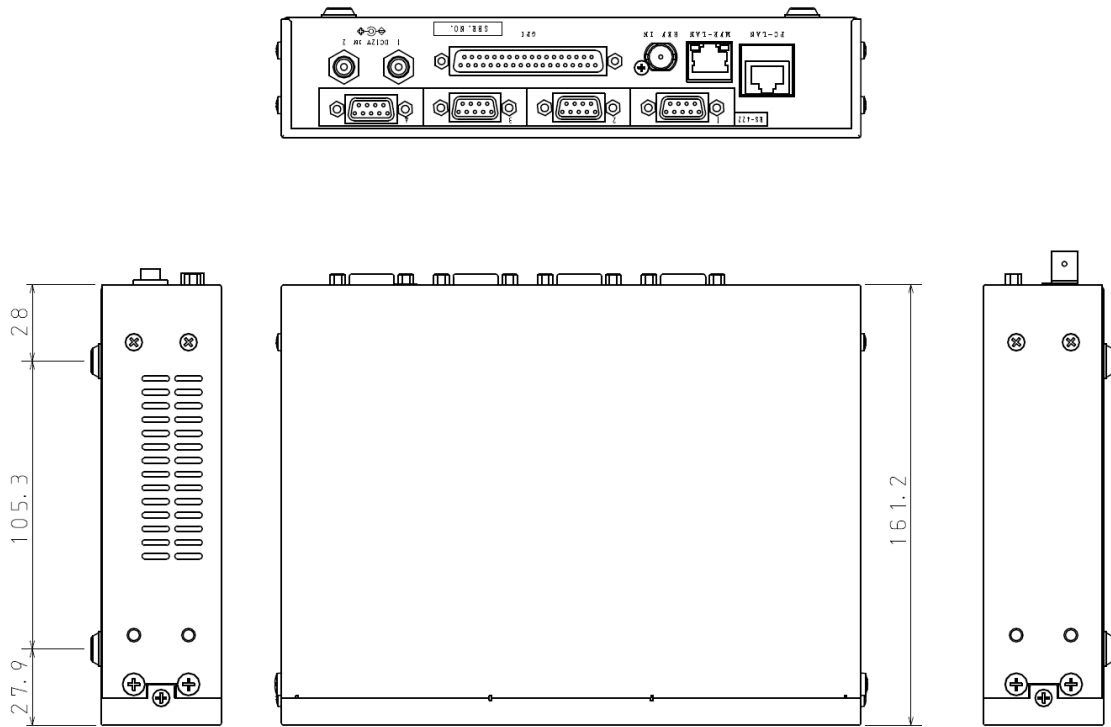

◆ If attaching the rack mount brackets (Dual / Single)

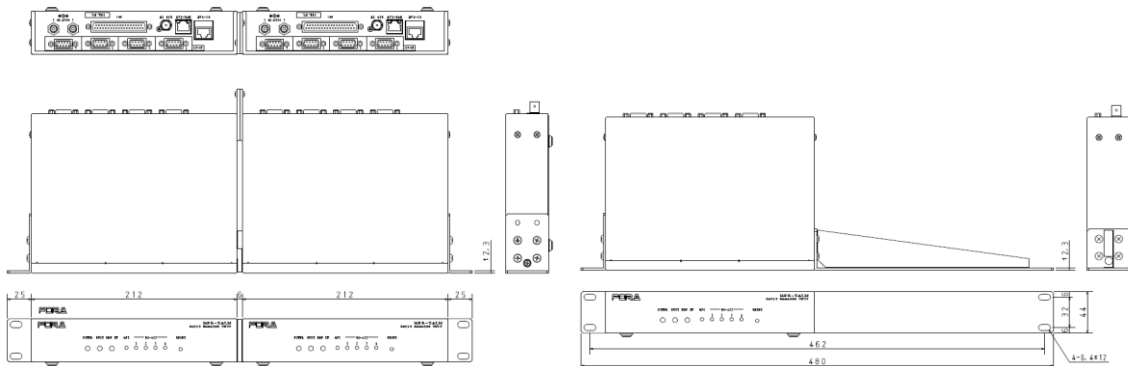

Appendix: Operation Tips

How to use Page buttons

Page navigation functions can be assigned to the front panel buttons on Remote Control Units.

- ▶ See Sec. 5-2-2 “Page Function” and Sec. 5-3. “Function Buttons.”
- ▶ See [Web-based Control: RU Settings > **Assign Function**]

◆ Page Up/Page Down buttons

These buttons allow you to move one page forward/back. If the page reaches to the end, it loops back to the first page.

Ex) Assign Page Up for Group B to Button 9 in the Web GUI

- (1) Click **System Settings** in the left pane.
- (2) Click to select [(RU name)-**Assign Function**] in the left pane to display the setting page.
- (3) Select **9** under [Button ID].
- (4) Select **Page** under [Function].
- (5) Select **UP** under [Up/Down] and **B** under [Group].
- (6) Click **Send** to apply settings.

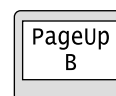

◆ Page Jump buttons

These buttons allow you to go back and forth between specified pages.

Ex) Assign Page Jump between 3 and 7 for Group B, C and D to Button 1 in the Web GUI

- (1) Click to select [(RU name)-**Assign Function**] in the left pane to display the setting page.
- (2) Select **1** under [Button ID].
- (3) Select **Page** under [Function].
- (4) Select **Jump** under [Up/Down] and enable B, C and D under [Group], then select **3** under [Fwd] and **7** under [Rev].
- (5) Click **Send** to apply settings.

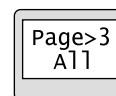

If **HOME** is set for [Rev], pressing the button lets you move between the current page and Page. If you are in Page 3 (Fwd setting), the button label is displayed highlighted.

The MFR-16RUD/39RU/39RUA units allow you to assign functions to buttons by front panel operation.

- ▶ For default page buttons on the RU front panel, see Sec. 2-6-1 “Front Panel.”
- ▶ For MFR-16RUD units, see Sec. 5-2-2. “Page Function.”
- ▶ For MFR-39RU units, see Sec. 5-4-3-4. “PAGE MODE”, 5-4-3-5. “PAGE ASSIGN” and 5-4-3-12. “BUTTON ASSIGN.”
- ▶ For MFR-39RUA units, see Sec. 5-4-4-4. “BUTTON ASSIGN” and 5-4-4-10. “PAGE.”

Warning

This equipment has been tested and found to comply with the limits for a Class A digital device, pursuant to Part 15 of FCC Rules. These limits are designed to provide reasonable protection against harmful interference when the equipment is operated in a commercial environment. This equipment generates, uses, and can radiate radio frequency energy and, if not installed and used in accordance with the instruction manual, may cause harmful interference to radio communications. Operation of this equipment in a residential area is likely to cause harmful interference, in which case the user will be required to correct the interference at his own expense.



FOR-A COMPANY LIMITED

Head Office 3-8-1 Ebisu, Shibuya-ku, Tokyo 150-0013, Japan
Overseas Division Tel: +81(0)3 3446 3936 Fax: +81(0)3 3446 1470
Japan Branch Offices Osaka/Okinawa/Fukuoka/Hiroshima/Nagoya/Sendai/Sapporo
R&D/Production Sakura Center/Sapporo Center

FOR-A Corporation of America

11155 Knott Ave., Suite G&H, Cypress, CA 90630, USA.
Tel: +1 714 894 3311 Fax: +1 714 894 5399

FOR-A Corporation of America East Coast Office

2 Executive Drive, Suite 670, Fort Lee Executive Park, Fort Lee, NJ 07024, USA
Tel: +1 201 944 1120 Fax: +1 201 944 1132

FOR-A Corporation of America Distribution & Service Center

2400 N.E. Waldo Road, Gainesville, FL 32609, USA
Tel: +1 352 371 1505 Fax: +1 352 378 5320

FOR-A Corporation of America Miami Office

8333 North West 53rd Street Suite 427 Doral, FL 33166, USA
Tel: +1 305 931 1700 Fax: +1 714 894 5399

FOR-A Corporation of Canada

1131A, Leslie Street Suite 209, Toronto, Ontario M3C 2J6, Canada
Tel: +1 416 977 0343 Fax: +1 416 977 0657

FOR-A Europe S.r.l.

Via Volturmo 37, 20861 Brugherio MB, Italy
Tel: +39 039 91 64 811 Fax: +39 039 878 140

FOR A UK Limited

Trident Court, 1 Oakcroft Road, Chessington, KT9 1BD, UK
Tel: +44 (0)20 3044 2935 Fax: +44(0)20 3044 2936

FOR-A Italia S.r.l.

Via Volturmo 37, 20861 Brugherio MB, Italy
Tel: +39 039 881 086/103 Fax: +39 039 878 140

FOR-A Corporation of Korea

1007, 57-5, Yangsan-ro, Yeongdeungpo-gu, Seoul 150-103, Korea
Tel: +82 (0)2 2637 0761 Fax: +82 (0)2 2637 0760

FOR-A China Limited

708B Huateng Building, No. 302, 3 District, Jinsong, Chaoyang, Beijing 100021, China
Tel: +86 (0)10 8721 6023 Fax: +86 (0)10 8721 6033

FOR-A Middle East-Africa Office

Dubai Media City, Aurora Tower, Office 1407, P.O. Box 502688, Dubai, UAE
Tel: +971 (0)4 551 5830 Fax: +971 (0)4 551 5832

Agiv (India) Private Limited (FOR-A India)

2nd Floor, Valecha Chambers, Link Road, Andheri(W), Mumbai 400053
Tel: +91-22-26733623 Fax: +91-22-26393415