

IPEXCB Installation Guide

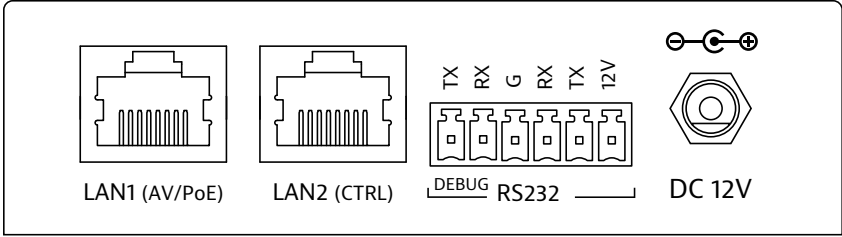

Important Safety Instructions

1. Read these instructions – All the safety and operating instructions should be read before this product is operated.
2. Keep these instructions – The safety and operating instructions should be retained for future reference.
3. Heed all warnings – All warnings on the appliance and in the operating instructions should be adhered to.
4. Follow all instructions – All operating and use instructions should be followed.
5. Do not use this apparatus near water – The appliance should not be used near water or moisture – for example, in a wet basement or near a swimming pool, and the like.
6. Clean only with a dry cloth.
7. Do not block any ventilation openings. Install in accordance with the manufacturer’s instructions.
8. Do not install near any heat sources such as radiators, heat registers, stoves, or other apparatus (including amplifiers) that produce heat.
9. Do not defeat the safety purpose of the polarized plug. A polarized plug has two blades with one wider than the other. The wide blade or the third prong is provided for your safety. If the provided plug does not fit into your outlet, consult an electrician for replacement of the obsolete outlet.
10. Protect the power cord from being walked on or pinched particularly at the plugs, convenience receptacles, and at the point where it exits from the apparatus.
11. Only use attachments/accessories specified by the manufacturer.
12. Use only with the cart, stand, tripod, bracket, or table specified by the manufacturer, or sold with the apparatus. When a cart or rack is used, use caution when moving the cart/ apparatus combination to avoid injury from tip-over.
13. Unplug the apparatus during lightning storms or when unused for long periods of time.
14. Refer all servicing to qualified service personnel. Servicing is required when the apparatus has been damaged in any way, such as; the power-supply cord or plug is damaged, liquid has been spilt or objects have fallen into the apparatus, the apparatus has been exposed to rain or moisture, does not operate normally, or has been dropped.
15. CAUTION: Servicing instructions are for use by qualified service personnel only. To reduce the risk of electric shock, do not perform any servicing other than that contained in the operating instructions unless you are qualified to do so.
16. Do not install this equipment in a confined or built-in space such as a book case or similar unit. The equipment must remain in well ventilation conditions. Ventilation should not be impeded by covering the ventilation openings with items such as newspaper, table-cloths, curtains etc.
17. WARNING: Only use attachments/accessories (such as the battery etc.) specified or provided by the manufacturer.
18. WARNING: Refer to the information on the underside of the enclosure for electrical and safety information before installing or operating the apparatus.
19. WARNING: To reduce the risk of fire or electric shock do not expose this apparatus to rain or moisture. The apparatus shall not be exposed to dripping or splashing and objects filled with liquids, such as vases, shall not be placed on apparatus.
20. CAUTION: Danger of explosion if battery is incorrectly replaced. Replace only with the same or equivalent type.
21. WARNING: The battery shall not be exposed to excessive heat such as sunshine, fire or the like.
22. WARNING: The all-pole mains switch located on rear panel is used as the disconnect device, the switch shall remain readily operable.
23. WARNING: DO NOT INGEST BATTERY. CHEMICAL BURN HAZARD.
24. Keep new and used batteries away from children. If the battery compartment does not close securely, stop using the product and keep it away from children.
25. If you think batteries might have been swallowed or placed inside any part of the body, seek immediate medical attention.

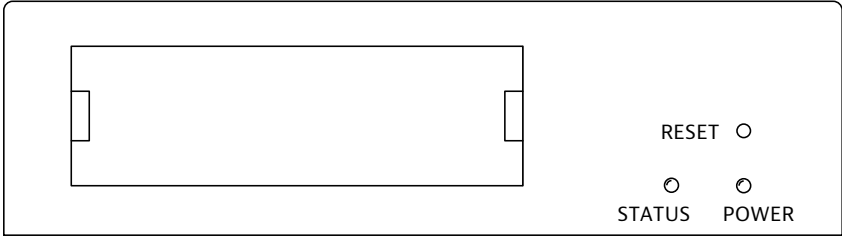

26. When the apparatus is not in use or during its relocation, take care of the power cord and plugs; e.g. tie up the power cord with cable tie or similar. The tie must be free from sharp edges and the like that might cause abrasion of the power cord. When put into use again ensure the power cord and plugs are not damaged. If any damage is found the power cord and plugs should be replaced by items either specified by the manufacturer or that have same characteristics as the original items.



27. This lightning flash with arrowhead symbol within an equilateral triangle is intended to alert the user to the presence of non-insulated “dangerous voltage” within the product’s enclosure that may be of sufficient magnitude to constitute a risk of electric shock.

28. **WARNING:** To reduce the risk of electric shock, do not remove cover (or back) as there are no user-serviceable parts inside. Refer servicing to qualified personnel.



29. The exclamation point within an equilateral triangle is intended to alert the user to the presence of important operating and maintenance instructions in the literature accompanying the appliance.



30. Protective earthing terminal. The apparatus should be connected to a mains socket outlet with a protective earthing connection.

31. **CAUTION:** To prevent electric shock hazard, replace grille. (CSA 60065, clause 5.3A)

Table of Contents

Important Safety Instructions	2
Product Overview	5
Package Contents	5
Front and Rear Panels	6
Front Panel	6
Rear Panel	6
Installation Instructions	7
Basic Installation	7
Reset Button	7
LAN Connections	7
12V Connection	7
RS232 Connections	8
IPLinx Config Software Usage	9
Download IPLinx Config Software	9
PC Connection	9
Run IPLinx Config Software	9
IPLinx Config Software Overview	10
Search for Devices on the Network	11
Renaming Encoders and Decoders	12
Create a Matrix and Video Wall	13
Create a New Group	13
Create a Matrix	15
Create a Video Wall	17
Verify Group Layouts	19
Single Display Configurations	20
Ungrouped Decoder	20
1x1 "Video Wall"	20
Video Wall Bezel Compensation (5000 series only)	21
Remove a Matrix or Video Wall	23
Remove a Layout	23
Remove a Video Wall	24
Remove a Group	24
2000-series Settings	25
IPEX2001 Video Settings	25
IPEX2002 Video Settings	27
5000-series Settings	28
IPEX5001 EDID Settings	28
IPEX5001 RS232 (Serial) Settings	28
IPEX5002 Video Settings	29
IPEX5002 Serial Settings	29
Remove an Encoder or Decoder from the Configuration	30
Saving and Loading Settings	31
Upload Settings to IPEXCB	31
Download Settings from IPEXCB	32
Save Settings to a File	33
Load Settings from a File	34
Technical Specifications	35

Product Overview

The IPLinx IPEXCB is an IP control box that is used as an A/V control device for controlling, configuring and managing encoders and decoders on the local area network. It integrates two Ethernet ports and two RS232 ports, offering integration-friendly control features, including a web GUI. The IPEXCB works directly with the IPLinx Control software for Windows and iPad. It can also be used with a third party controller to provide a simple, flexible control and management options.

The IPEXCB can automatically search and display encoders and decoders. It is designed to be compatible with the configuration file from the PC configurator software (IPLinx Config) and use the imported configuration file to perform operations on encoders and decoders such as matrix and video wall.

The IPEXCB is compatible with IPLinx IPEX2000 and IPEX5000 series streaming IP devices.

Package Contents

1. Installation Guide
2. Power Supply with US, UK, EU, and AU adapters
3. 6-pin Removable Screw Terminal
4. Device Labels

Front and Rear Panels

Front Panel

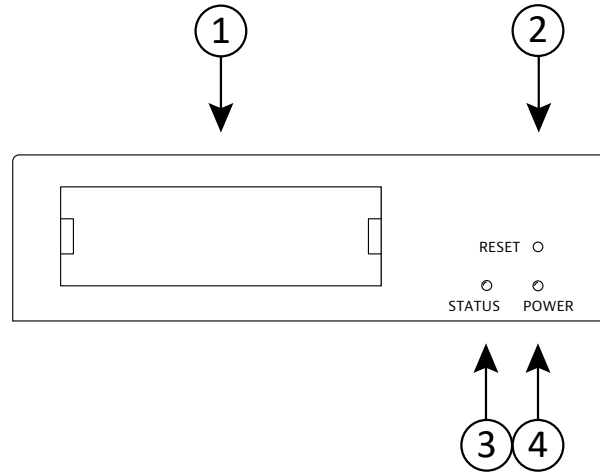

- 1. Label insert
- 2. Reset button
- 3. Status indicator
- 4. Power indicator

Rear Panel

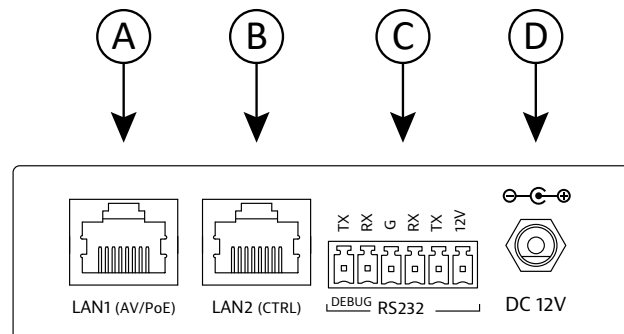

- A. LAN1 (AV/PoE)
- B. LAN2 (CTRL)
- C. RS232 connections
- D. 12V DC power input

Installation Instructions

Basic Installation

1. Configure the gigabit switch for IP video operation. Liberty has a network configuration guide, which includes settings for many common switch manufacturers, on the IPEXCB page on the Liberty website (www.libav.com).
2. Turn off power and disconnect the audio/video equipment by following the manufacturer's instructions.
3. Turn off power to the configured switch.
4. Connect Category 5E or greater twisted pair cable with the TIA/EIA-568B crimp pattern between the LAN1 port on the IPEXCB and the gigabit switch.
5. Connect the encoder(s) and decoder(s) to the gigabit switch per the instructions for those devices.
6. If the gigabit switch cannot provide power or enough power to the IPEXCB, connect the included power supply to the 12V DC power input of the control box. If the gigabit switch cannot provide enough power, disable the PoE function of the connected LAN port on the switch.
7. Connect all sources and displays to the respective encoders and decoders.
8. Apply power to the gigabit switch.
9. The IPEXCB will fully boot after five minutes.
10. Apply power to the attached audio/video devices.

Reset Button

Press and hold the reset button for five seconds to restore the IPEXCB to factory defaults.

LAN Connections

LAN1 is used to connect the IPEXCB to the Ethernet switch. The default IP address for LAN1 of the IPEXCB is 169.254.1.1.

LAN2 is used to connect the IPEXCB to a third party control system. The default IP address for LAN2 of the IPEXCB is 192.168.11.243.

12V Connection

The 12V connection on the right side of the RS232 connector can provide up to 500 mA of 12V DC to an external device.

RS232 Connections

The IPEXCB features two RS232 connections: Debug and Control. The Debug connection will only communicate with the IPEXCB and will not control any encoders or decoders.

To use the RS232 control transport capabilities of the IPEXCB, connect the TX, RX, and ground control signal wires to the middle RS232 connections on the removable 6-pole terminal block. Consult the manual of the control device to determine which pins the TX and RX signals are carried on. Be sure to always connect TX to RX and RX to TX.

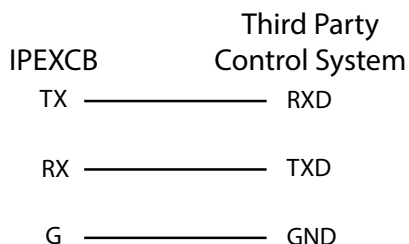

The RS232 control ports require a standard straight-through serial cable for operation. The default settings for the RS232 ports are:

- Debug connection: 115200 baud, 8 Data Bits, 1 Stop Bit, Parity = none
- Control connection: 9600 baud, 8 Data Bits, 1 Stop Bit, Parity = none

While the IPEXCB requires RS232 commands to be sent to it at 9600 baud through the control connection, multiple baud rates are available to communicate with the remote devices.

IPLinx Config Software Usage

Download IPLinx Config Software

The IPLinx Config software can be found on the IPEXCB page of Libav.com. Run the setup file (*IPLinxConfig_Setup.exe*) on the Windows PC that will be used to configure the IPEXCB and associated encoders and decoders.

PC Connection

Connect a Windows PC to an open port on the Ethernet switch with a Cat 5e patch cable.

Set a static IP address for the Windows PC that is within the IP range of the IPEXCB (169.254.xxx.xxx) and set the subnet mask to 255.255.0.0.

Please contact an IT administrator if the PC cannot be assigned a static IP address in this range.

Run IPLinx Config Software

Open the IPLinx Config software. The link to the software can be found in the Windows Start menu or on the desktop if the option was enabled during setup.

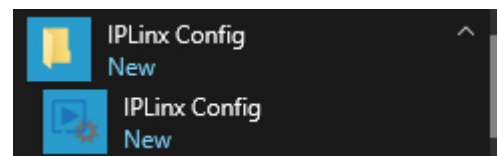

If a firewall warning pops up, tick the check boxes for private and public networks.

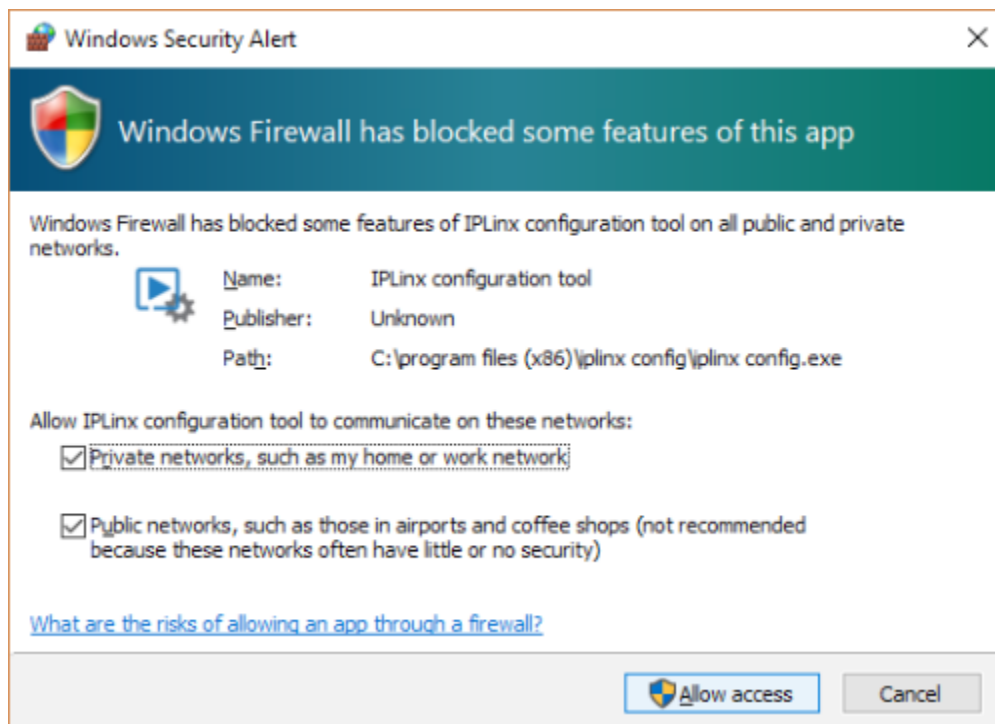

Some IT administrators may prevent the IPLinx Config software from accessing the IP video network even though the firewall permissions were approved. Please make sure that UDP ports 1234, 3333, 3334 and TCP ports 55000 through 56999 are open for proper access to the IP video network.

IPLinx Config Software Overview

The IPLinx Config software will typically present a popup reminding the user to press the *Search* button to find attached devices on the network. Ticking the check box will prevent this from opening in the future.

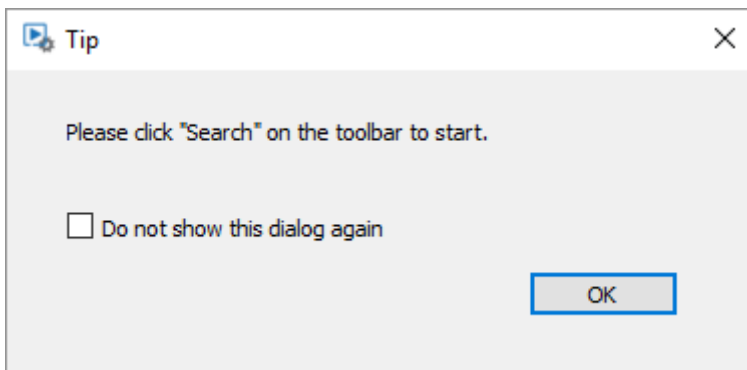

The IPLinx Config software is split into three primary zones: RX on the left (decoders), TX and other on the right (IPEXCB and encoders), and the Group area in the middle.

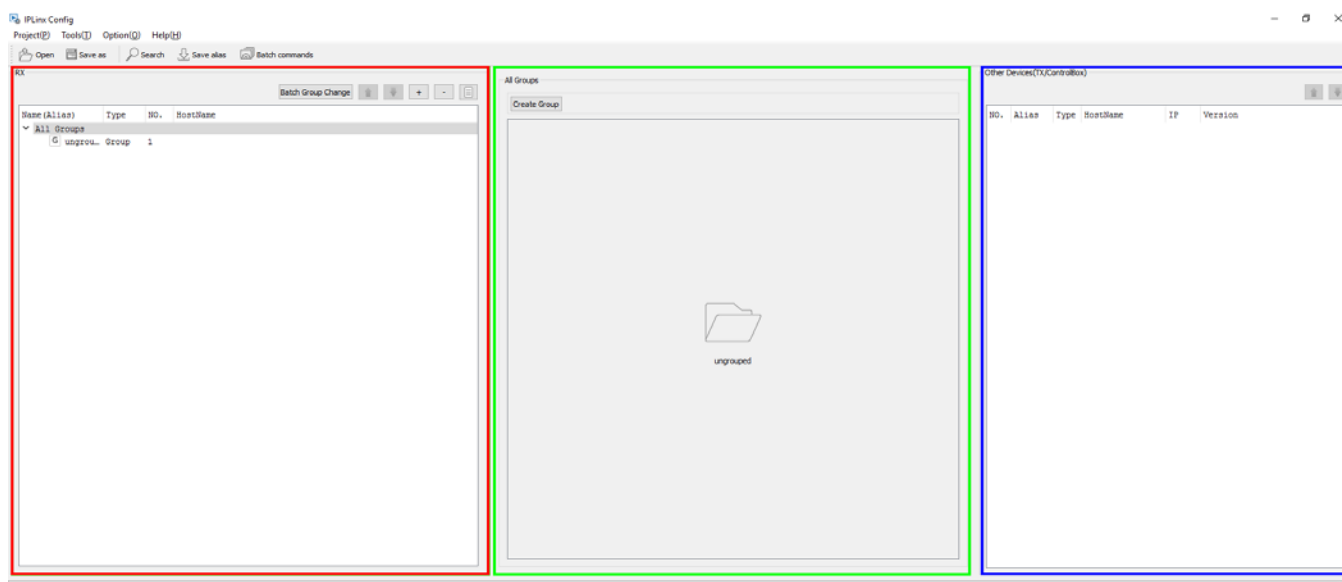

The IPEXCB should be the first device that is discovered by the software if the PC is correctly connected to the Ethernet switch and within the IP range of the control box.

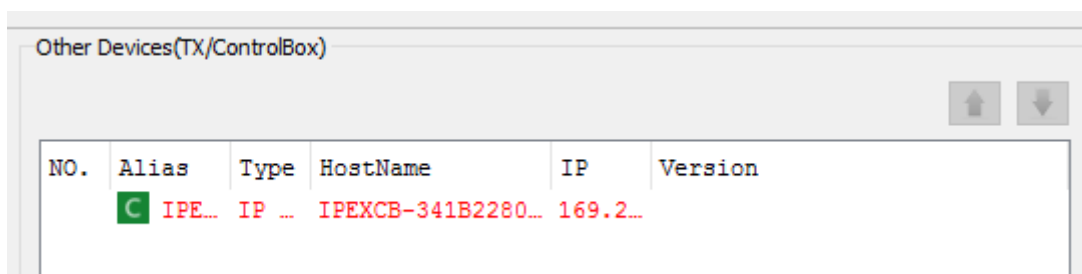

Search for Devices on the Network

Clicking the *Search* button will tell the IPEXCB to scan the network for compatible encoders and decoders.

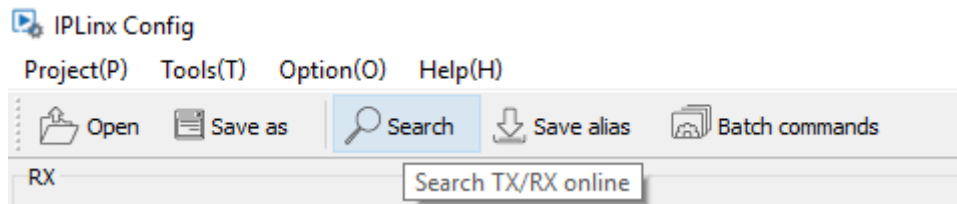

After the search is complete, a popup window will display the number of total devices found on the network, including the IPEXCB.

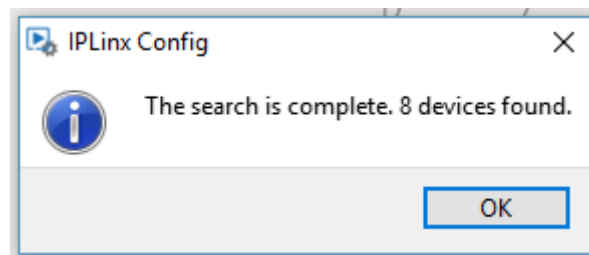

Name (Alias)	Type	NO.	HostNa:
<ul style="list-style-type: none"> <ul style="list-style-type: none"> <ul style="list-style-type: none"> G ungrouped 	Group	1	
R IPEX2002-341B228017...	RX	1	IPEX200
R IPEX2002-341B228017...	RX	2	IPEX200
R IPEX2002-341B228013...	RX	3	IPEX200
R IPEX2002-341B228017...	RX	4	IPEX200

If a discovered device loses the connection to the network, the green box will change to white.

Temporarily disconnecting an encoder or decoder can help determine which device is at which location in an installation or when providing an alias for the device.

Name (Alias)	Type	NO.	HostNa:
<ul style="list-style-type: none"> <ul style="list-style-type: none"> <ul style="list-style-type: none"> G ungrouped 	Group	1	
R IPEX2002-341B228017...	RX	1	IPEX200
R IPEX2002-341B228017...	RX	2	IPEX200
R IPEX2002-341B228013...	RX	3	IPEX200
R IPEX2002-341B228017...	RX	4	IPEX200

Renaming Encoders and Decoders

To rename a device, except for the IPEXCB, right click the device and select *Config*.

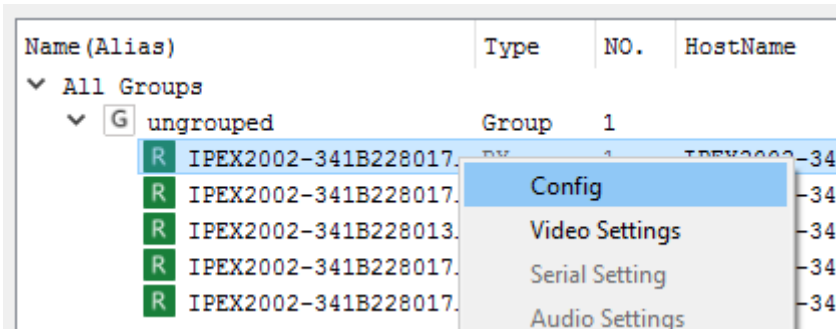

The default Alias is the device host name. Enter a new Alias for the device, then click *Apply*. Clicking the X will close the popup.

To prevent any switching issues, only alphanumeric characters and hyphen (-) are allowable characters.

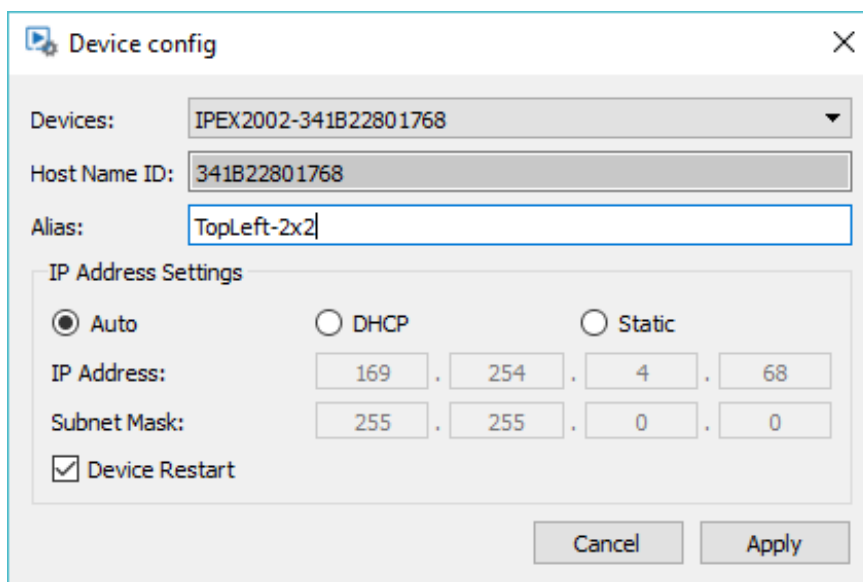

When the encoders and decoders have an Alias applied, the Alias will show up in the device listings.

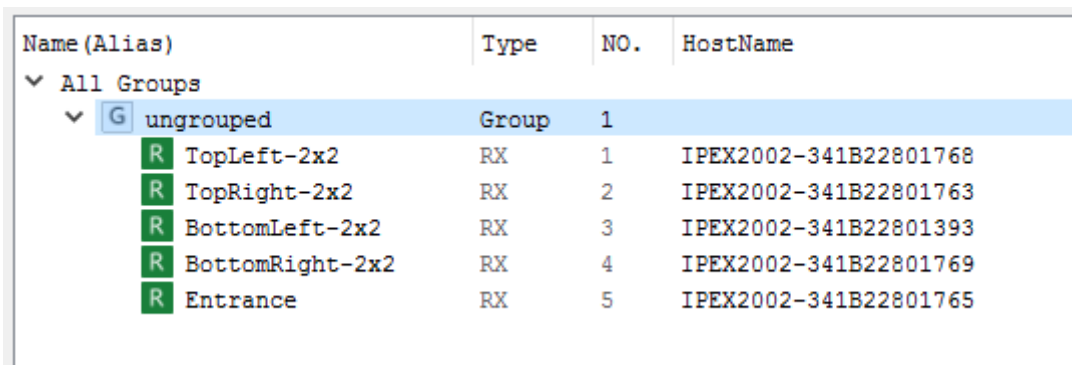

Create a Matrix and Video Wall

Create a New Group

With *All Groups* selected on the left panel, click *Create Group* at the top of the middle panel.

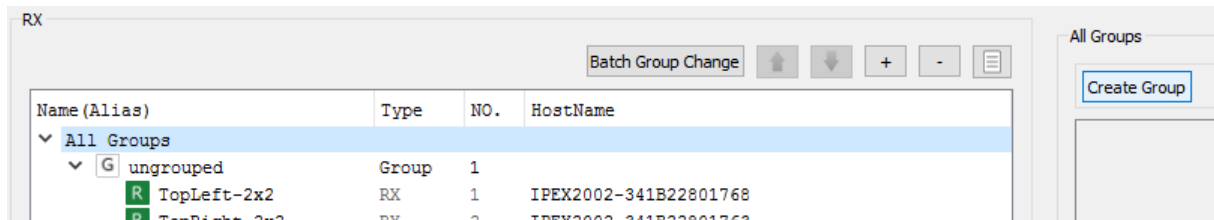

Provide a name for the new group, then click *OK*.

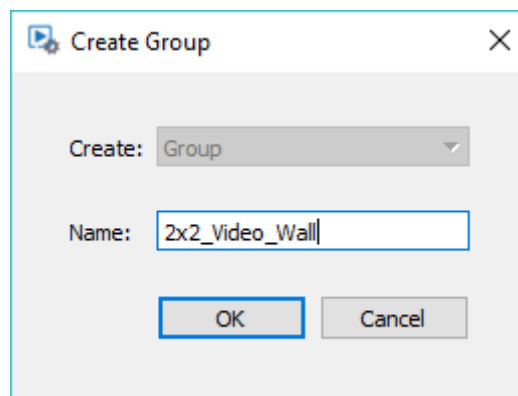

With the new group selected in the left panel, click the *Create VW* button at the top of the middle panel. This will create a new video wall configuration.

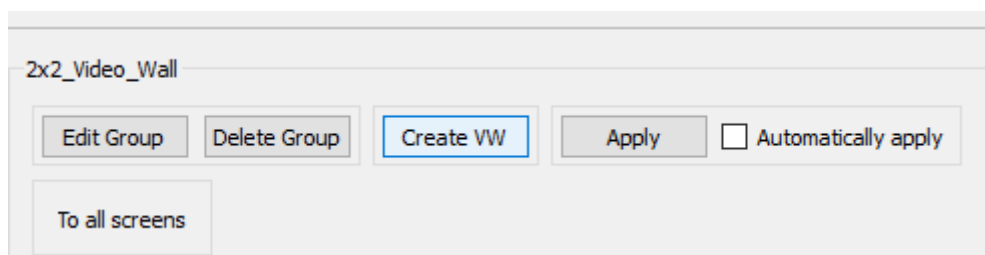
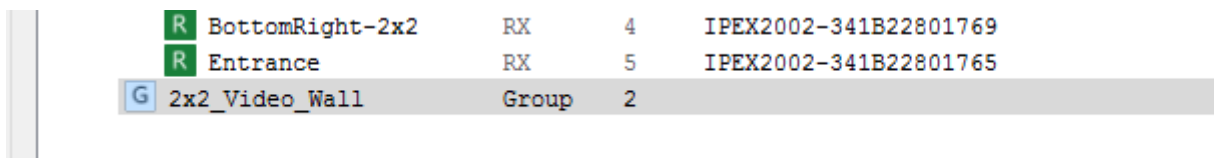

Select the number of rows and columns to be used in the matrix output or video wall configuration. There is a maximum of 16 rows and 16 columns per group. When naming the video wall, spaces are not allowed, but an underscore (_) may be used.

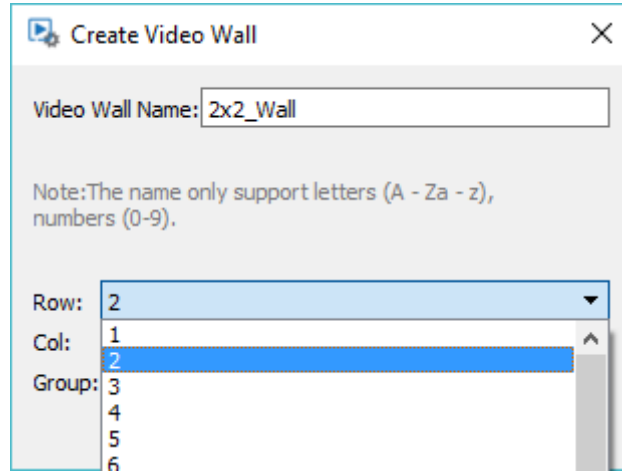

Click *OK* to create the video wall. The configuration will show up beneath the group that was just created and a visual representation will appear in the middle section of the IPLinx Config software.

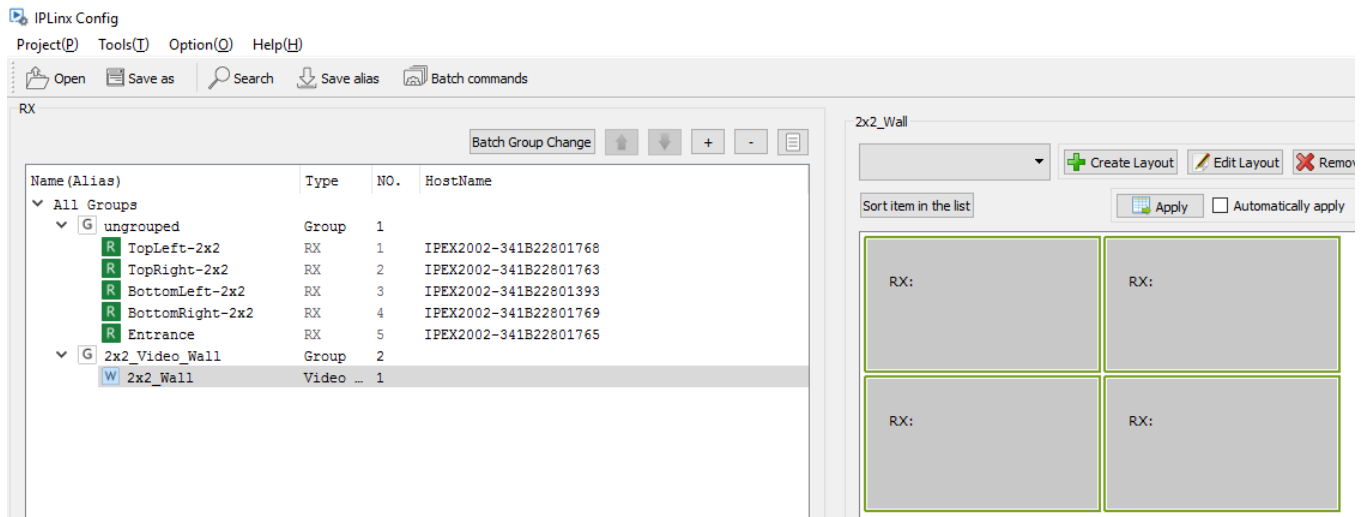

Create a Matrix

With the newly created video wall sub-group selected on the left panel, click *Create Layout* at the top of the middle panel. The video wall visual representation should also be seen in the middle panel.

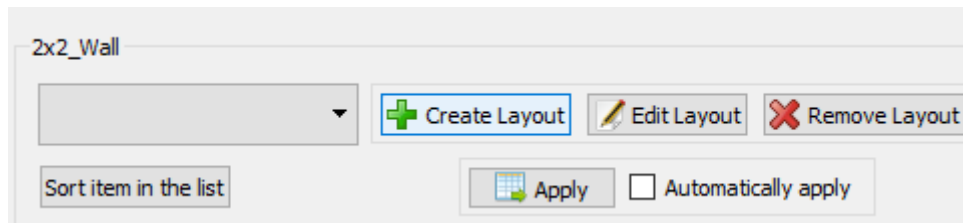

Enter a name for the matrix, such as *Matrix*, then click *OK*.

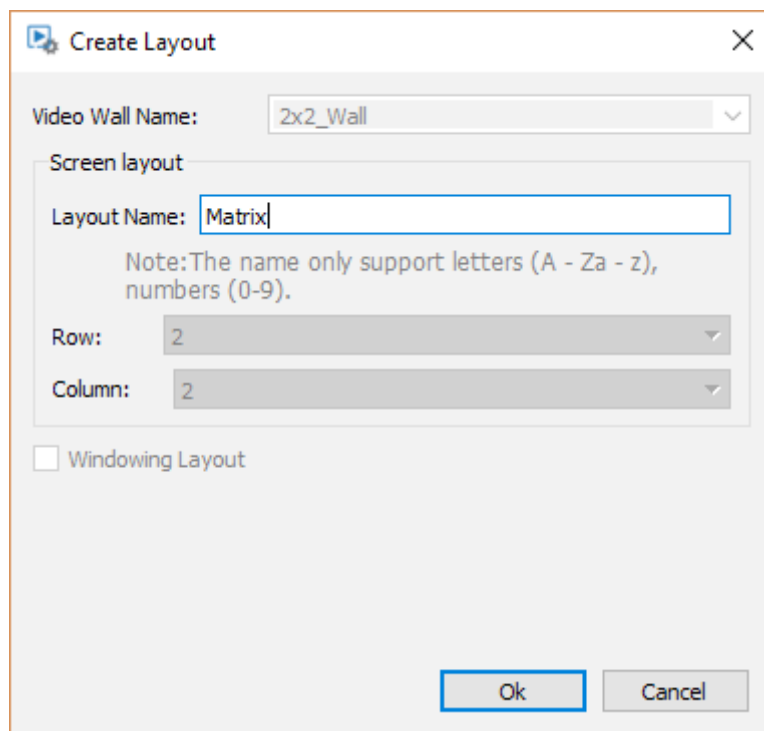

Drag the decoders in the ungrouped section of the left panel to the respective display locations within the matrix layout. As each decoder is assigned to a location, it will disappear from the ungrouped section.

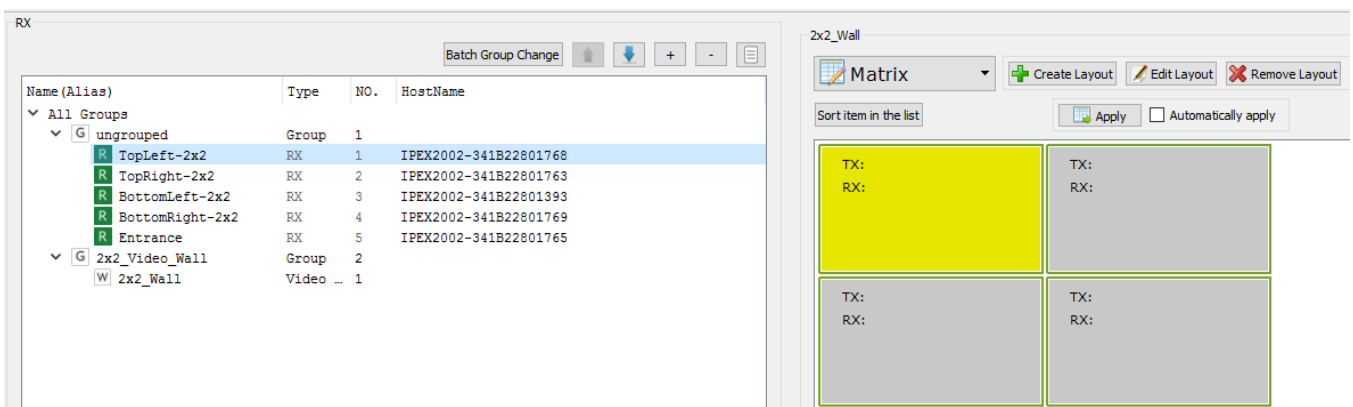

The RX portion of the visual representation will show the assigned decoders in each display slot.

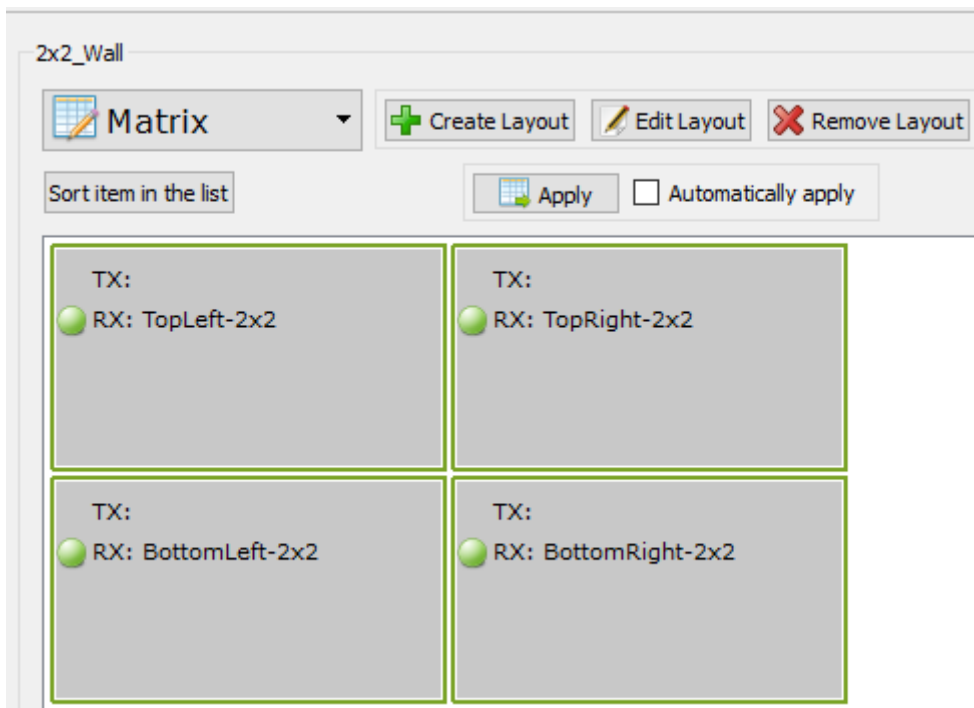

Repeat the process with the encoders to assign a predefined AV route whenever the current layout is selected. This step is optional.

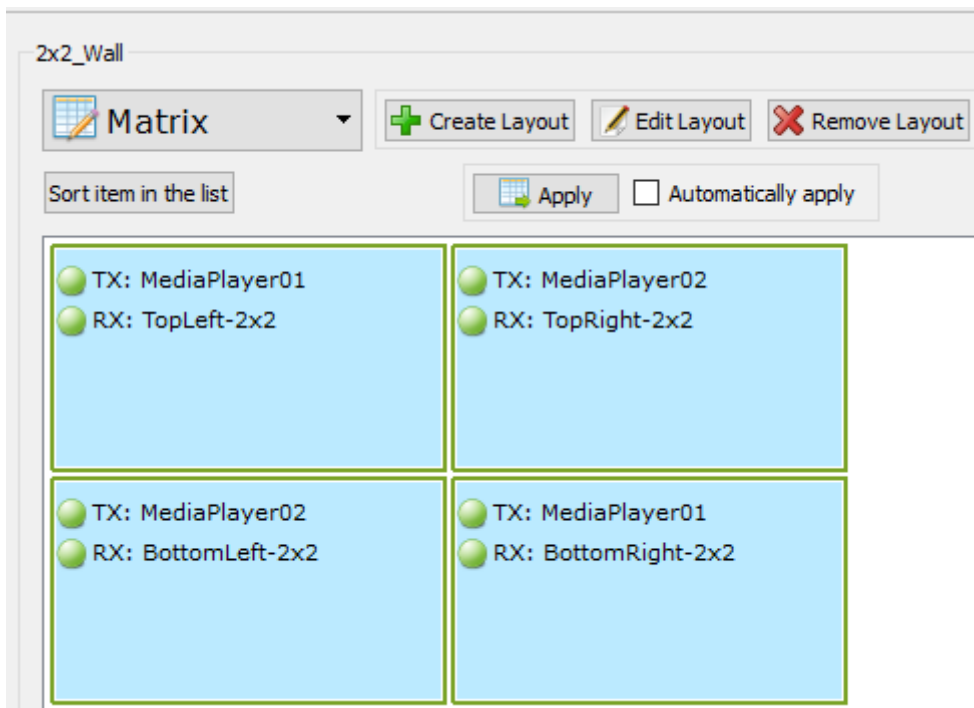

Create a Video Wall

With the newly created video wall sub-group selected on the left panel, click *Create Layout* at the top of the middle panel. The video wall visual representation should also be seen in the middle panel.

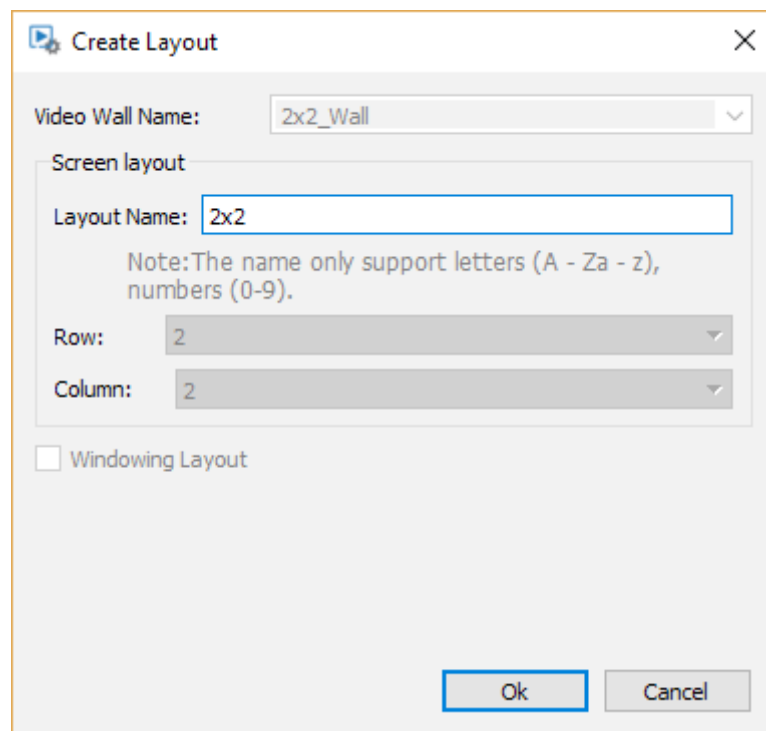
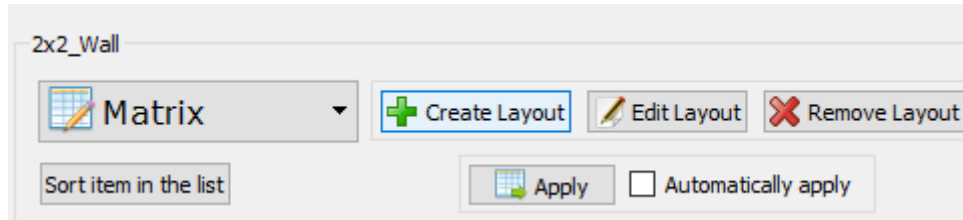

Drag the decoders in the ungrouped section of the left panel to the respective display locations within the matrix layout. As each decoder is assigned to a location, it will disappear from the ungrouped section.

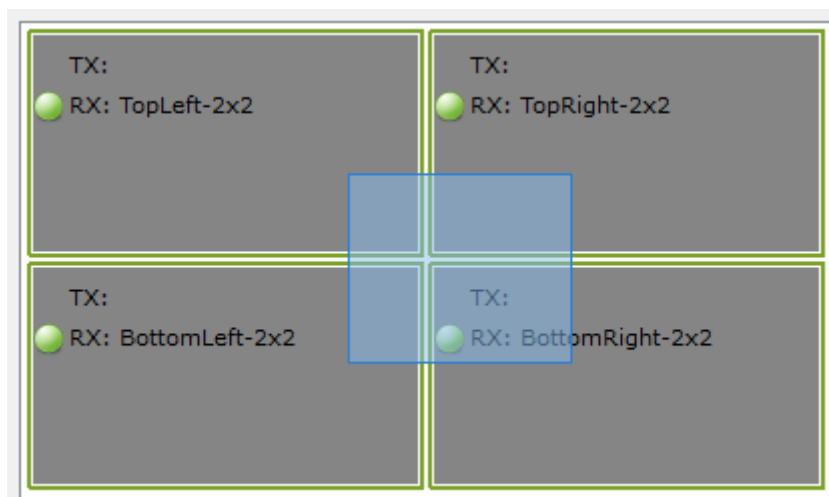

Release the right mouse button and click *Combine*.

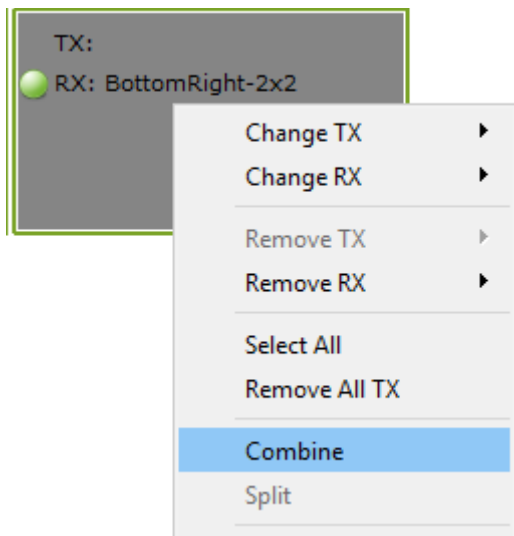

Provide a simple name, such as *vw*, in the *Logic Properties* window, then click *OK*.

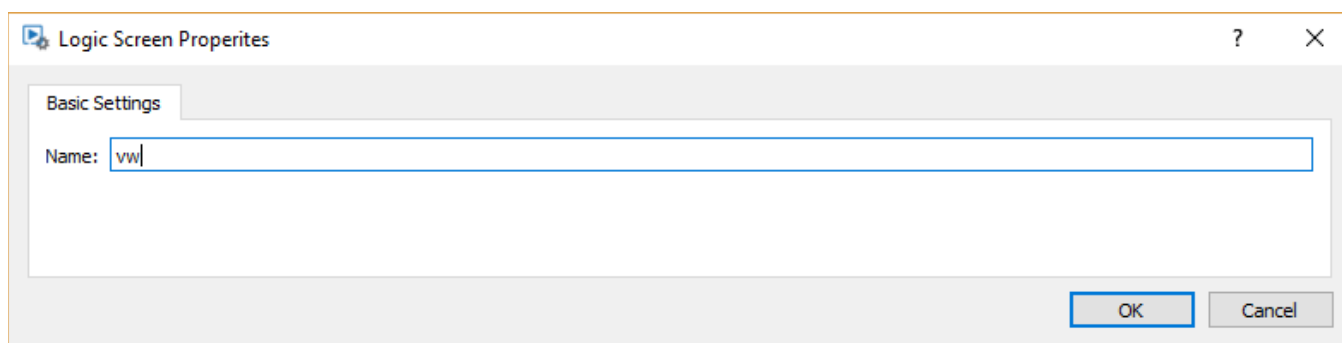

A blue line will surround the visual representation of the displays and a dotted line will separate each display, which indicates the configuration is a logical video wall.

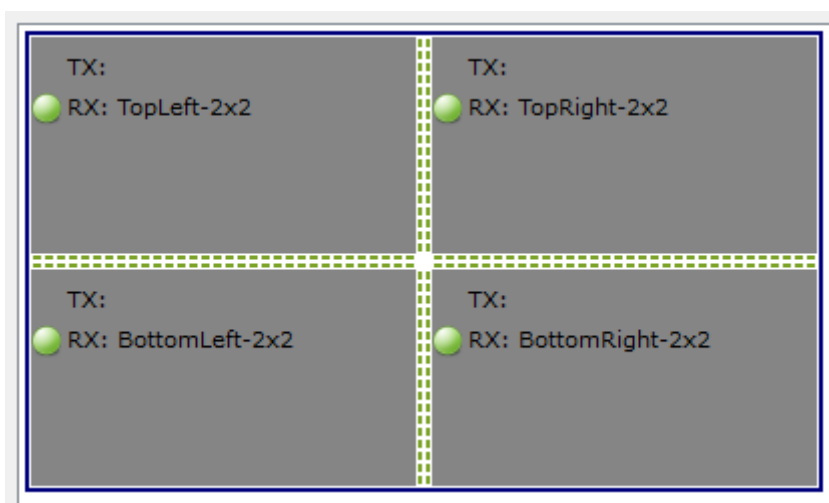

Provide a simple name, such as *vw*, in the *Logic Properties* window, then click *OK*.

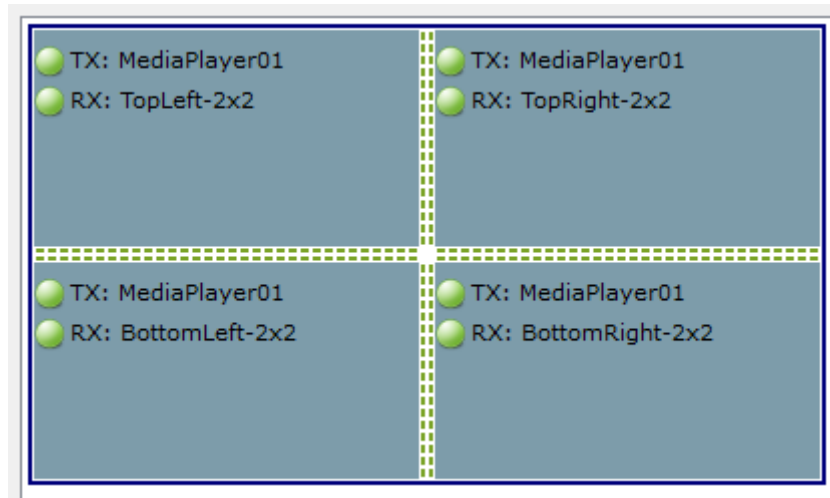

Verify Group Layouts

Clicking the dropdown list at the top of the middle section with the video wall group selected will show all layouts that have been created.

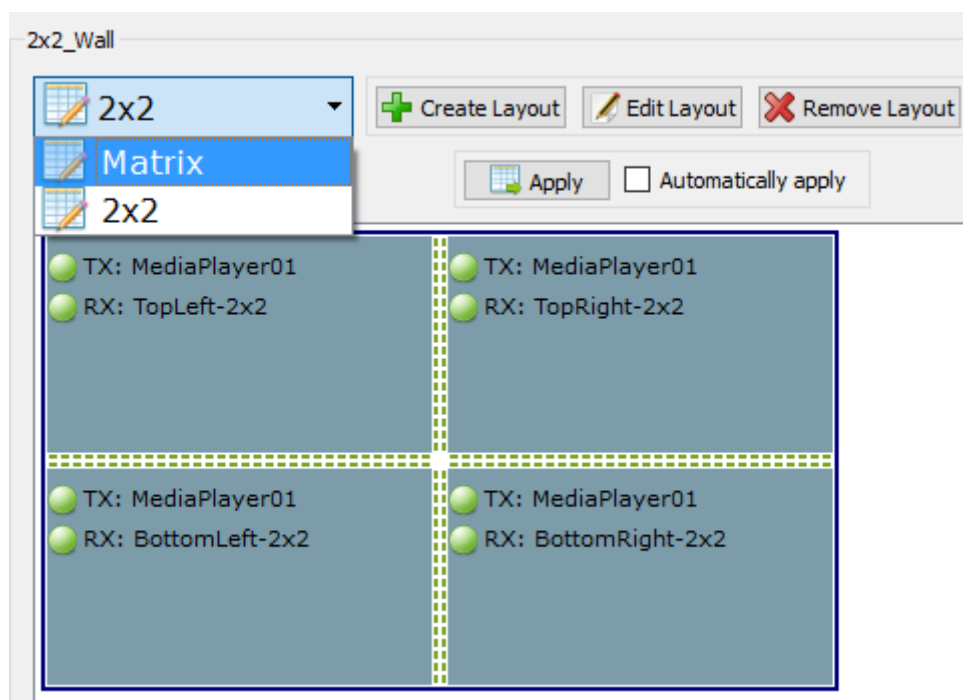

Single Display Configurations

A single display may be left in the upgrouped section of the decoders in the left panel or be added to a 1x1 video wall group.

Ungrouped Decoder

Drag and drop a decoder to assign a default source to the display.

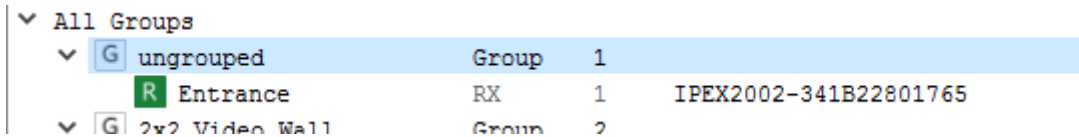

Drag and drop an encoder onto the decoder to assign a default source to the display.

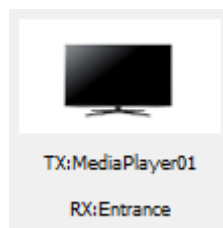

1x1 “Video Wall”

Create a 1x1 video wall using the same steps in the *Create a Video Wall* section.

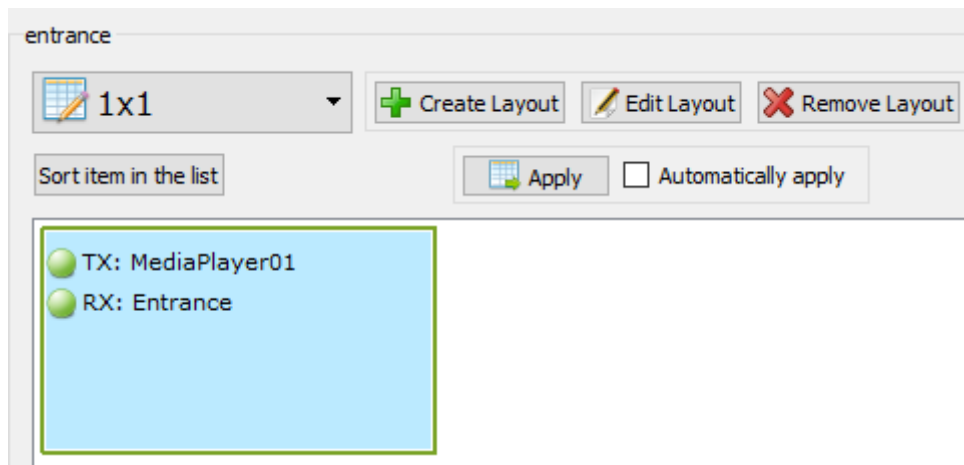

Video Wall Bezel Compensation (5000 series only)

To compensate for bezel size in a video wall, right click on the video wall group and select *Video Wall Properties* from the menu.

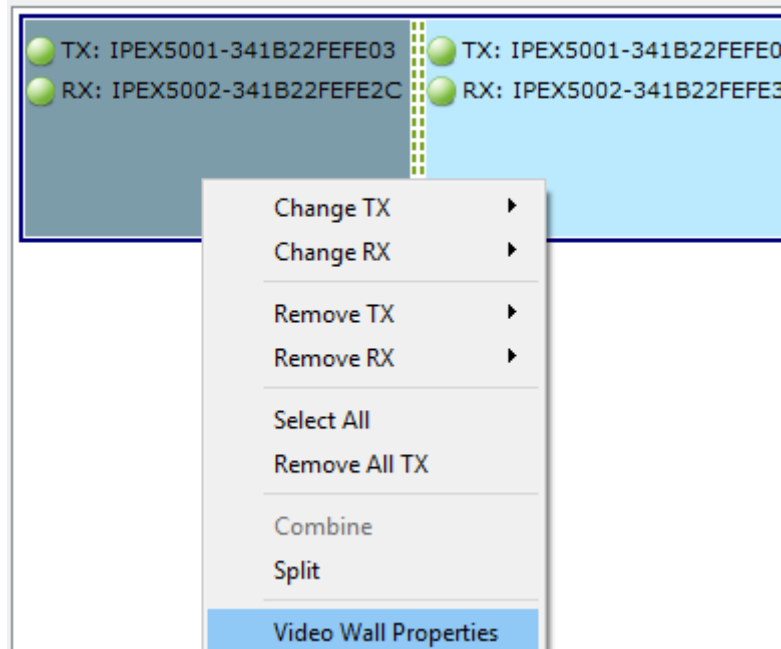

The *Basic Settings* tab allows the outside and viewable dimensions of the display to be configured to offset the image in order to maintain proper aspect ratios of the source content. The number values are referring to 0.1 mm increments.

Suppose a 43 inch LED TV has an 8 mm bezel with outside dimensions of 970 mm x 569 mm. The following values would be entered into the tab: OW = 9700, OH = 5690, VW = 9540, and VH = 5530.

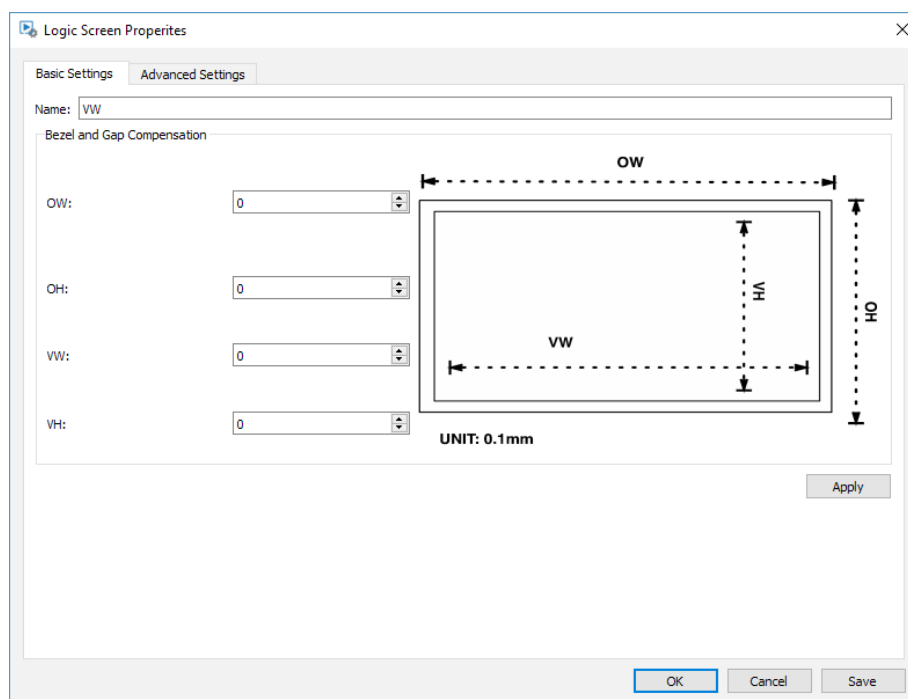

The *Advanced Settings* tab allows correcting the video output on an individual display.

Horizontal Shift will shift the video image to the left or right. If the display is on the left edge of the video wall, the image cannot be shifted to the right. A single unit is 8 pixels.

Vertical Shift will shift the video image up or down. If the display is on the top edge of the video wall, the image cannot be shifted down. A single unit is 8 pixels.

Horizontal Scale Up will stretch or shrink the video image horizontally. The scale is one pixel per number of columns in the video wall.

Vertical Scale Up will stretch or shrink the video image vertically. The scale is one pixel per number of rows in the video wall.

Tearing Delay is used to compensate for screen tearing and is applied when the source content covers the entire video wall. In a 3 x 3 video wall, the tearing delay would only affect a 3x3 video wall image. A 2 x 2 video wall image on the 3 x 3 wall will ignore the tearing correction. The values are defined in microseconds with typical values ranging between 10000 and 16000.

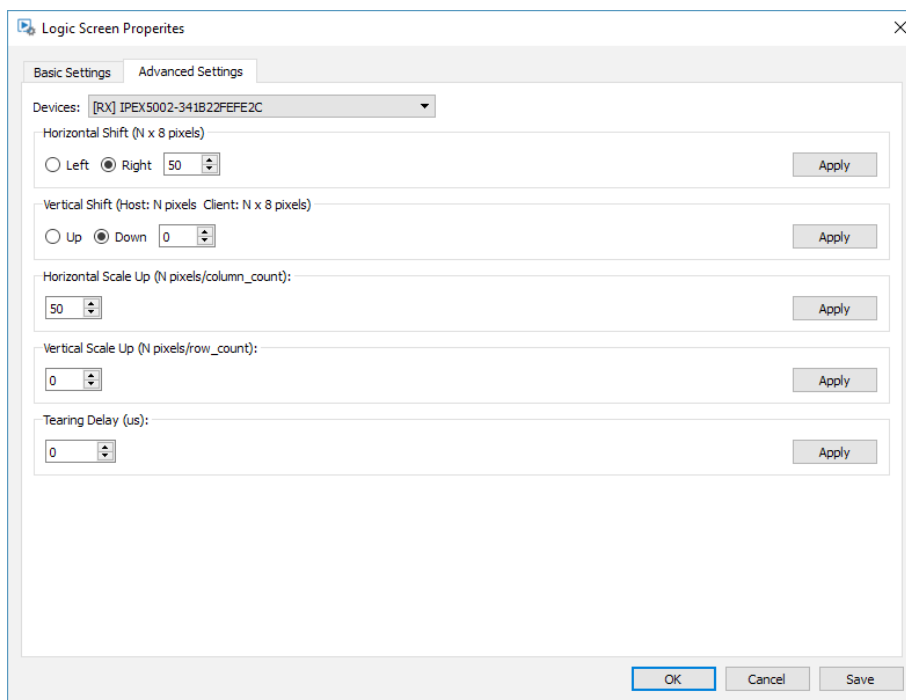

Remove a Matrix or Video Wall

Remove a Layout

To remove a layout, click the *Remove Layout* button with a valid video wall selected.

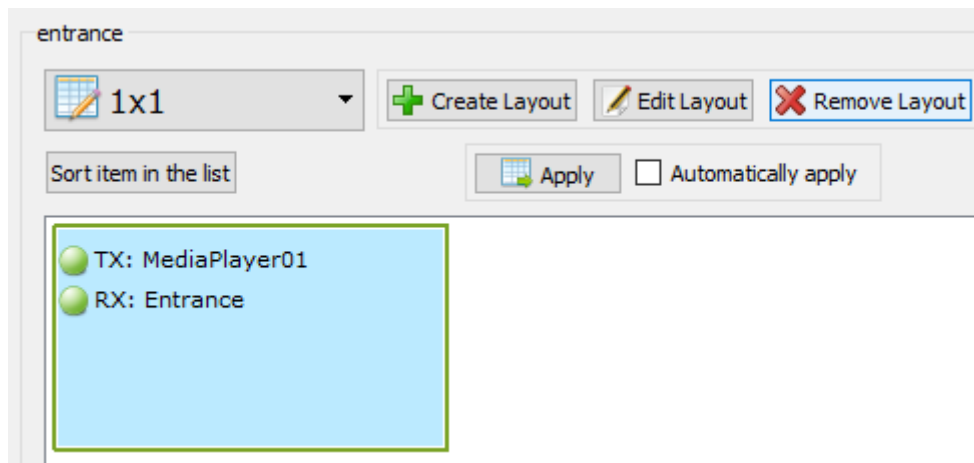

A confirmation window will open to confirm the deletion of the layout.

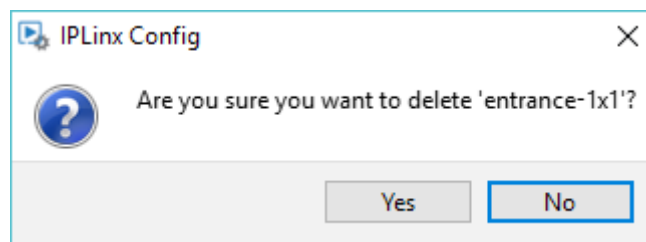

If this is the last layout for the video wall, another confirmation window will open to confirm the final deletion.

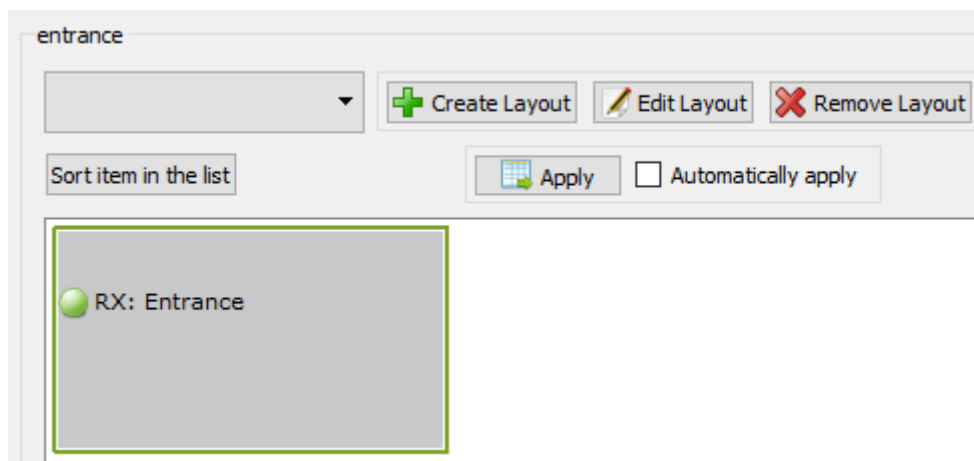
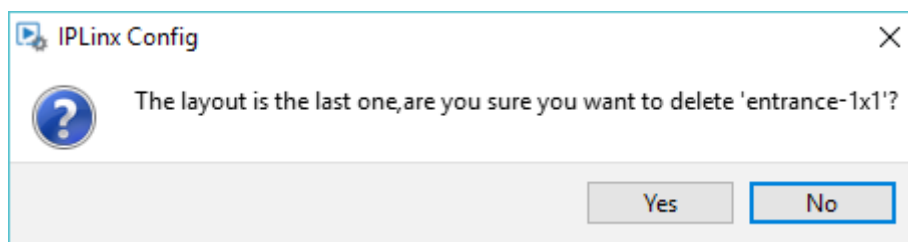

Remove a Video Wall

To remove a video wall layout, right click on the name of the video wall, and click *Delete Video Wall*.

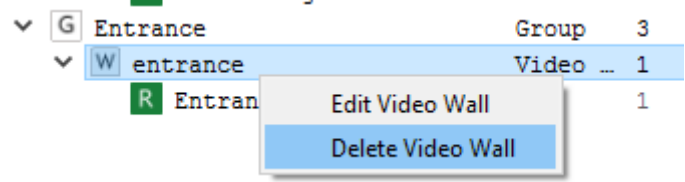

A confirmation window will open to confirm the deletion of the video wall.

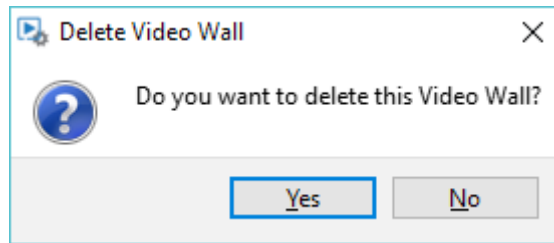

After the video wall is deleted, the video wall reference will be removed from the group.

Remove a Group

To remove a video group, right click on the name of the group, and click *Delete Group*.

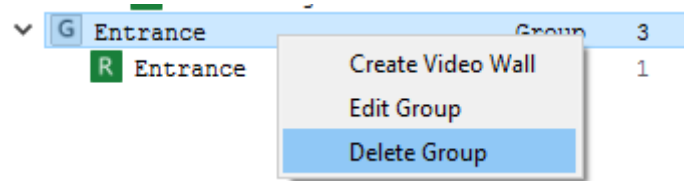

A confirmation window will open to confirm the deletion of the video group.

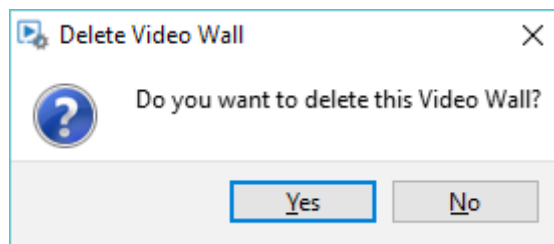

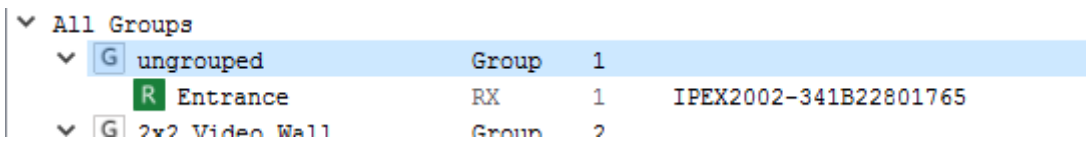

After the group is deleted, all assigned encoders will be moved to the *ungrouped* group.



2000-series Settings

IPEX2001 Video Settings

To configure the video settings of an IPEX2001, right click on the name of the encoder and select *Video Settings*.

NO.	Alias	Type	HostName
	 IPEXCB-341B2...	IP ...	IPEXCB-341B...
1	 MediaPlayer01	TX	IPEX2001-34...
2	 Med		1-34...

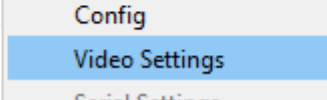

In the *Basic* tab, tick the *Enable* or *Disable* radio button under *HDCP Settings* to change the video encryption mode of the source device.

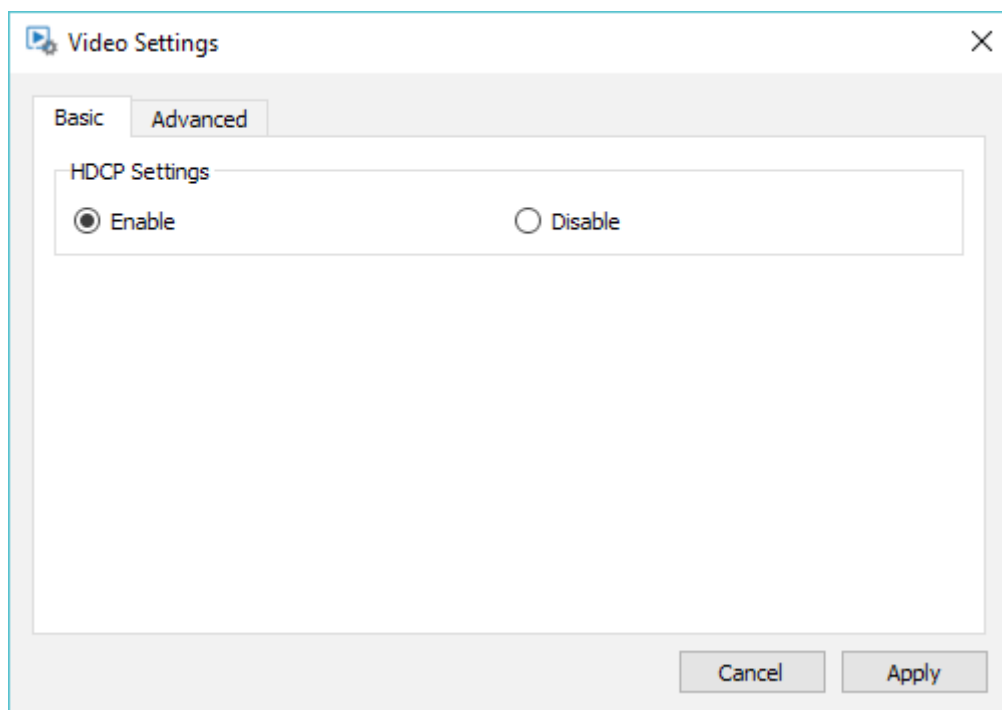

In the *Advanced* tab, tick the *Modify Advanced Parameters* box to access different methods to adjust the bandwidth and quality of the source signal.

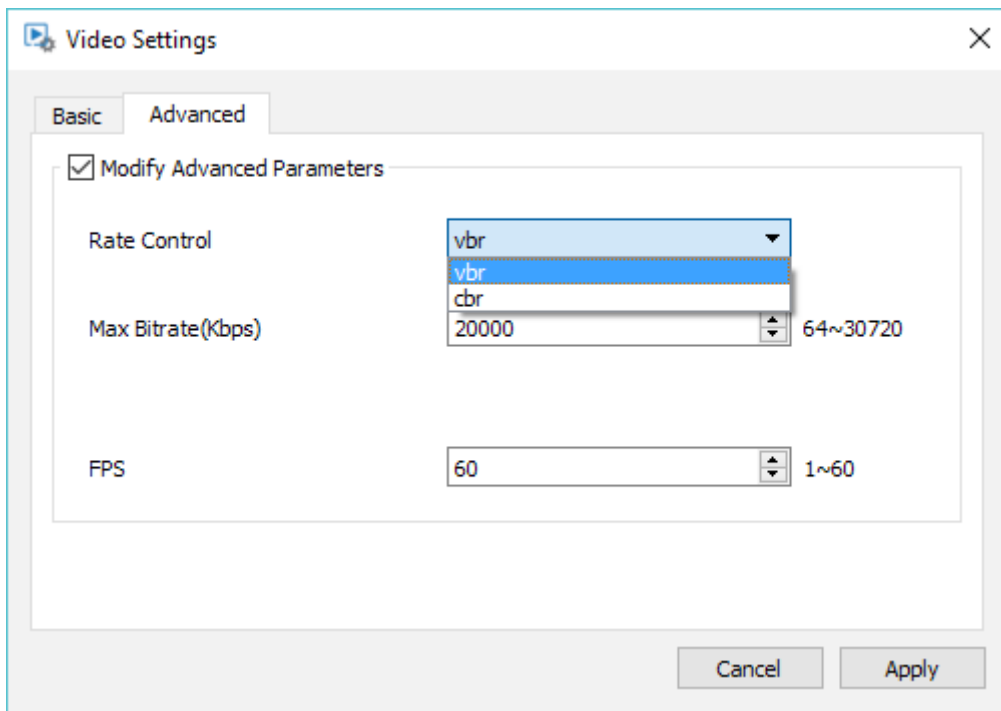

IPEX2002 Video Settings

To configure the video settings of an IPEX2002, right click on the name of the encoder and select *Video Settings*.

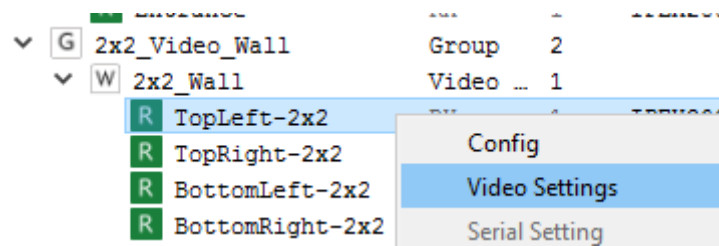

The *Basic* tab allows specifying a specific output resolution for a connected display.

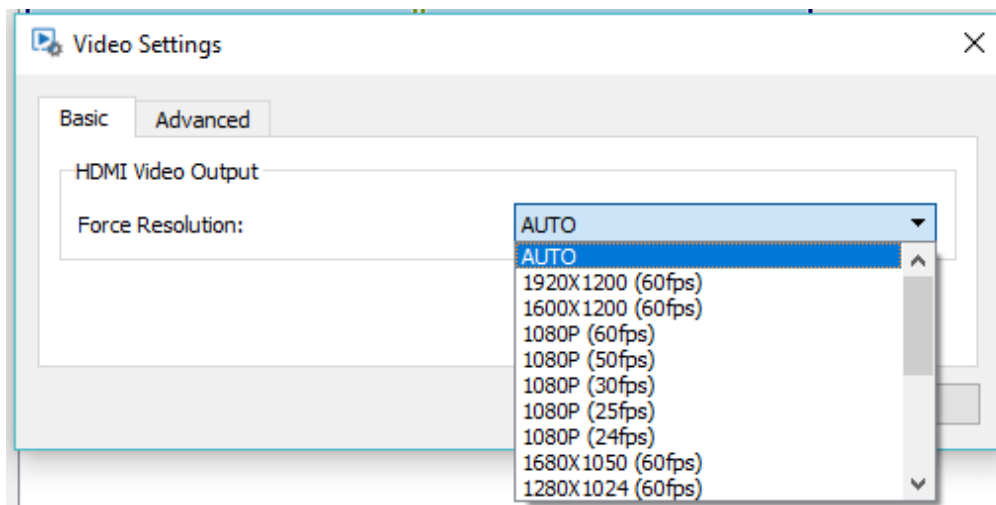

In the *Advanced* tab, tick the Low delay settings box to choose between high quality video with a longer delay or low delay with lower video quality.

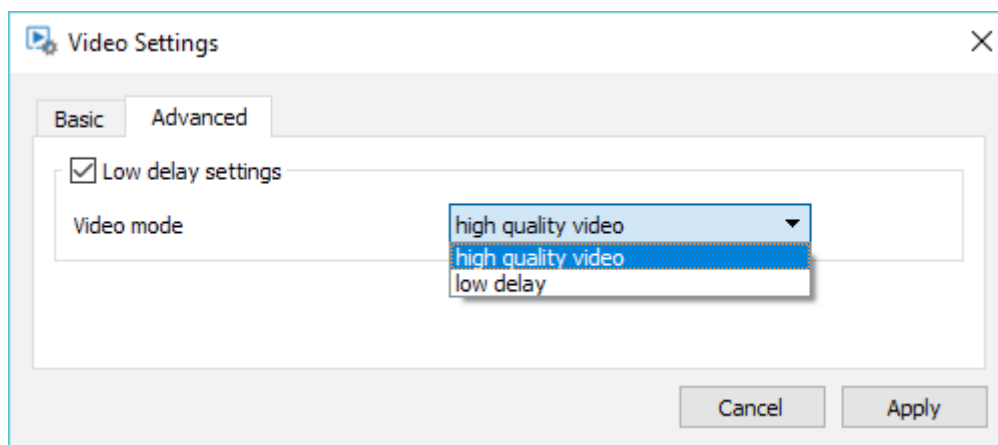

5000-series Settings

IPEX5001 EDID Settings

To define the EDID settings of an IPEX5001, right click on the name of the encoder and select *EDID Settings* at the bottom of the options list.

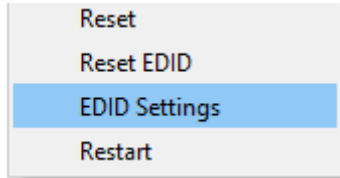

Select one of the built-in EDIDs to determine the audio settings for the source. The 2160p EDID tables also include support for 1080p24 and 1080p60.

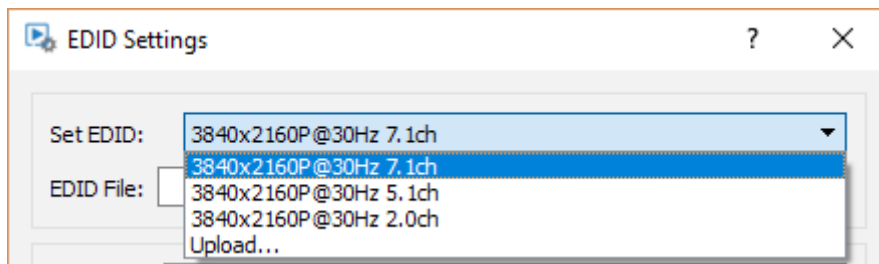

IPEX5001 RS232 (Serial) Settings

To configure the serial settings of an IPEX5001, right click on the name of the encoder and select *Serial Settings*.

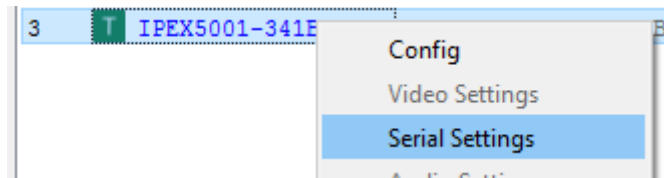

The IPEX5001 can connect to devices with baud rates between 50 baud and 230400 baud.

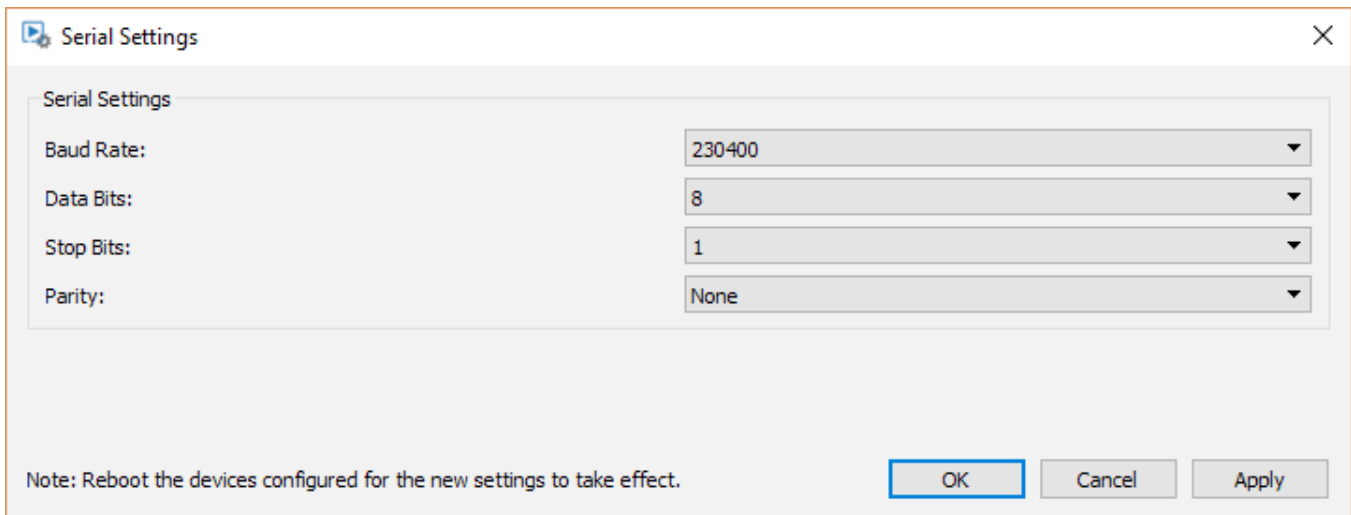

IPEX5002 Video Settings

To configure the video settings of an IPEX5002, right click on the name of the decoder and select *Video Settings*.

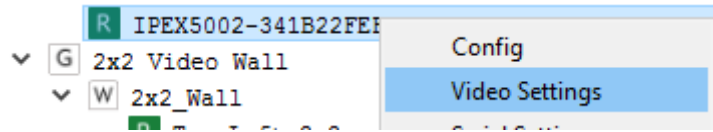

Some of the options in the *Video Settings* window are HDCP output type, video output resolution, no video behavior, and screen rotation. In order for the changes to take effect, the IPEX5002 must be restarted.

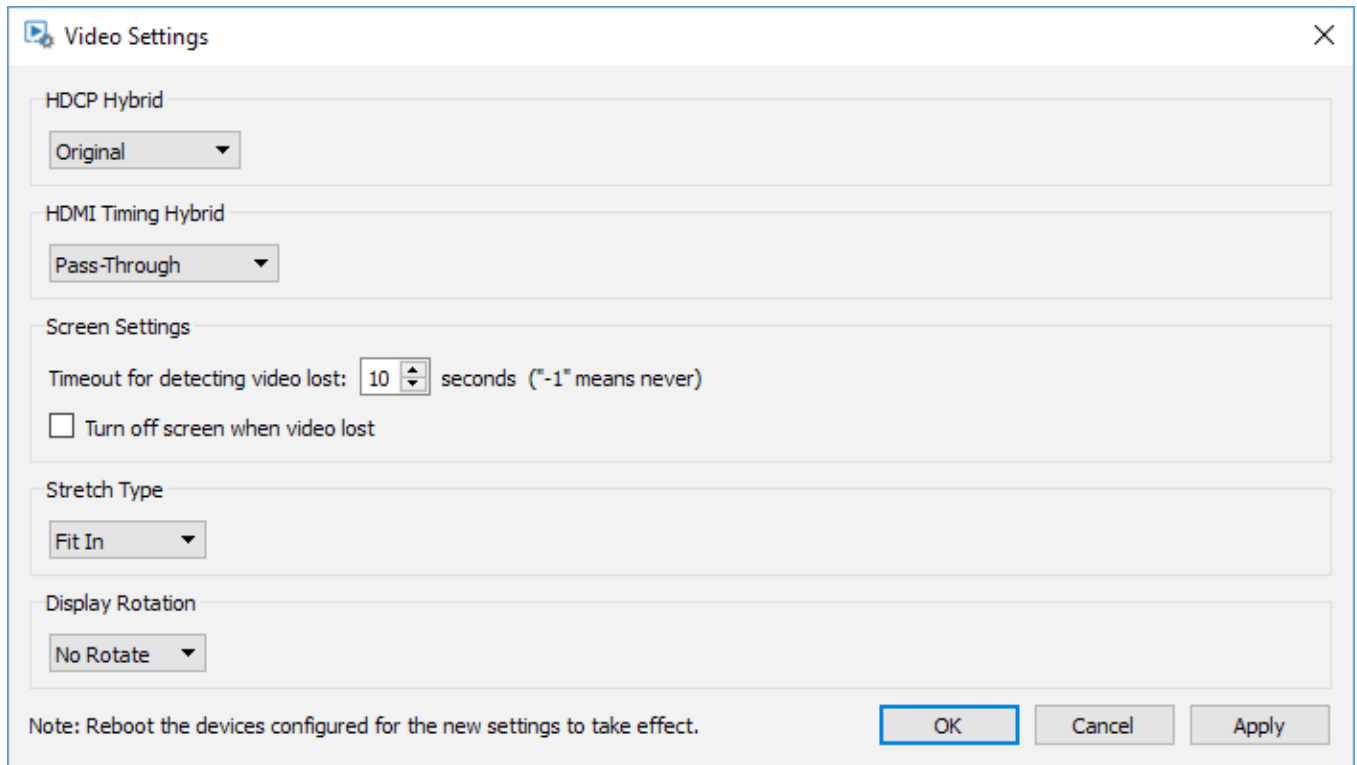

The *HDCP Hybrid* options allow setting the output HDCP settings to match the original content, force HDCP 1.x mode, or force HDCP 2.2 mode.

The *HDMI Timing Hybrid* options define the output video resolution of the IPEX5002. Pass-Through will bypass the scaling function of the decoder.

IPEX5002 Serial Settings

To configure the serial settings of an IPEX5002, right click on the name of the encoder and select *Serial Settings*.

The IPEX5002 can connect to devices with baud rates between 50 baud and 230400 baud.

These settings are identical to the settings in the IPEX5001.

Remove an Encoder or Decoder from the Configuration

To remove an encoder or decoder from the configuration of the AV system, right click on the name of the encoder or decoder, then click *Delete*.

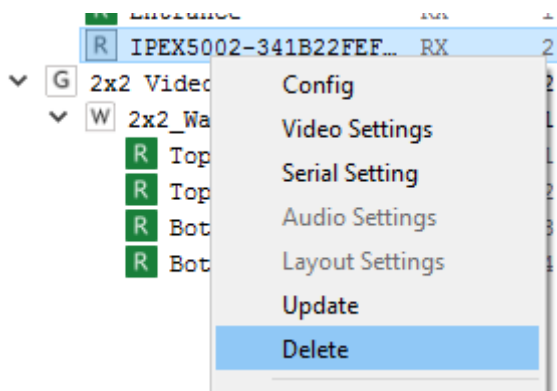

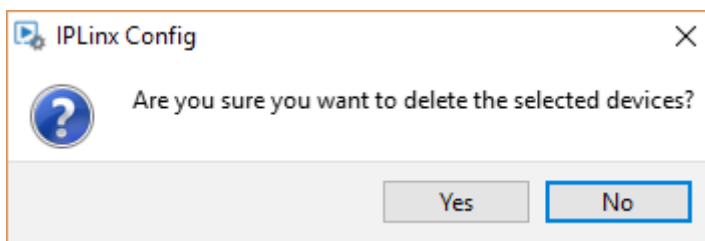

A confirmation window will open to confirm the deletion of the encoder or decoder.



Saving and Loading Settings

Upload Settings to IPEXCB

In order for the configuration to be used in a live system, it must be uploaded to the connected IPEXCB. Right click on the IPEXCB in the right panel and click *Upload*.

NO.	Alias	Type	HostName
	 IPEXCB-34		B-341B2280
1	 MediaPlayer		001-341B22
2	 MediaPlayer		001-341B22

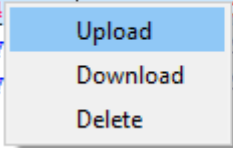

Click Yes in the upload confirmation window.

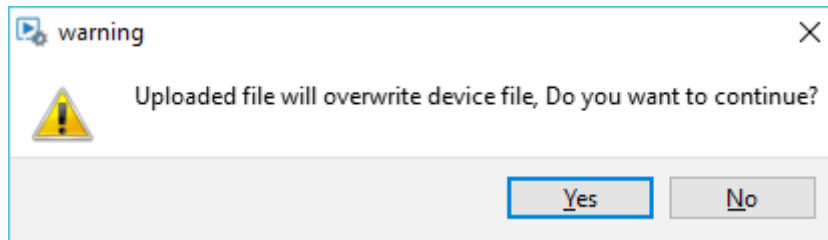

After a few seconds, the progress window will show the upload is complete. Click *OK* once the button is no longer grayed out.

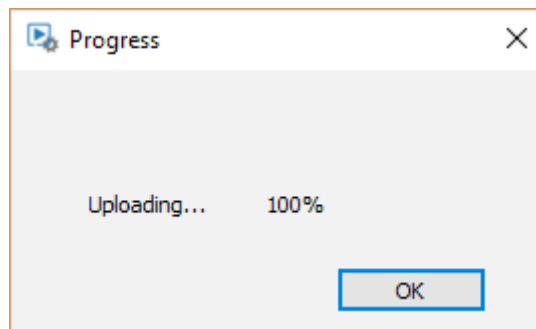

Download Settings from IPEXCB

To access the current system configuration, it must be downloaded from the IPEXCB. Right click on the IPEXCB in the right panel and click *Download*.

NO.	Alias	Type	HostName	IP
	C IPE...	IP ...	IPEXCB-341B2280...	169.2...
1	T IF		1-341B22...	169.2...
2	T IF		1-341B22...	169.2...
3	T Me		1-341B22...	169.2...

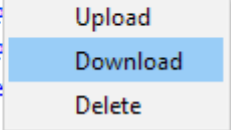
A context menu is shown over the first row of the table. The menu items are 'Upload', 'Download', and 'Delete'. The 'Download' option is highlighted in blue.

Click *Yes* in the download confirmation window.

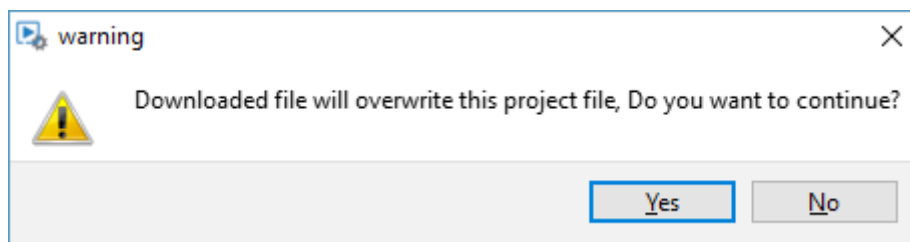

After a few seconds, the progress window will show the download is complete. Click *OK* once the button is no longer grayed out.

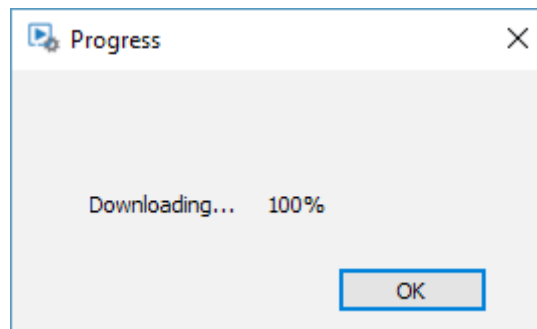

Save Settings to a File

Click the *Save as* button or navigate to *Project > Save as* to save the current system to a file in case the IPEXCB becomes damaged or must be reset to factory defaults.

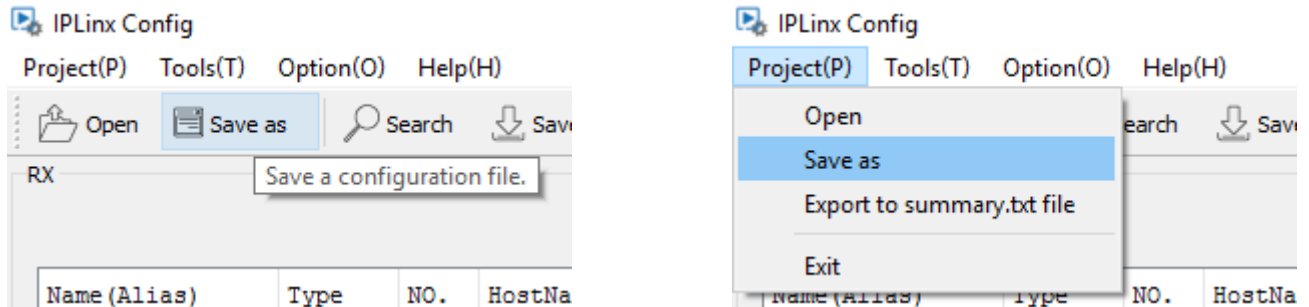

Provide a name for the save file, then click *Save*.

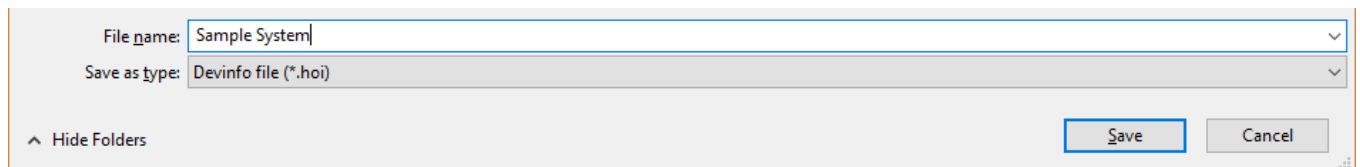

A status window will show the save is complete. Click *OK*.

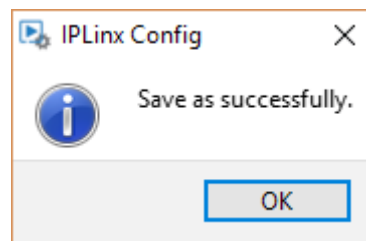

Load Settings from a File

Click the *Open* button or navigate to *Project > Open* to load a saved system file in case the IPEXCB became damaged or was reset to factory defaults.

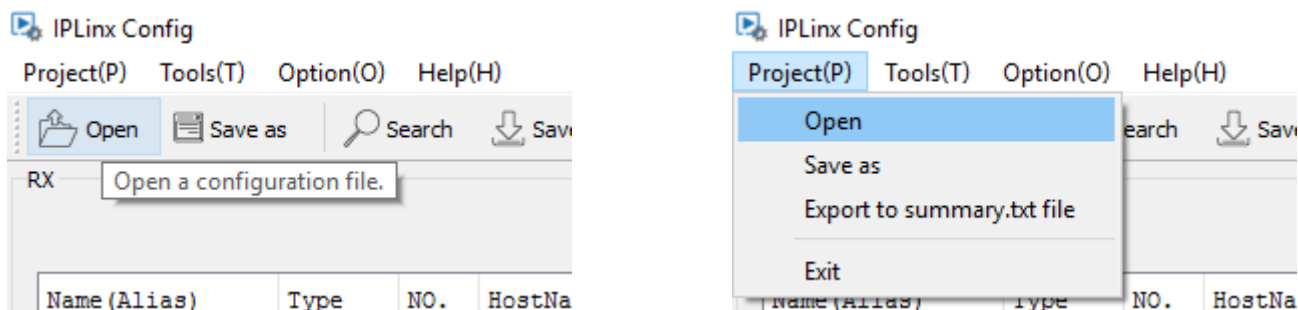

Select the name for the previously saved file, then click *Open*.

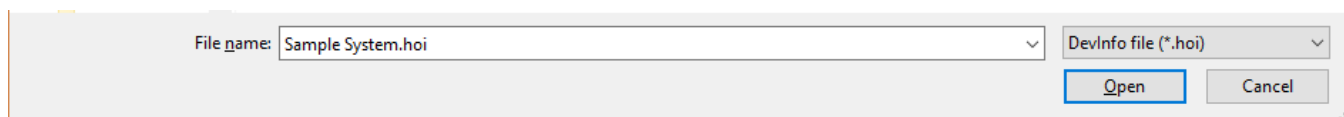

A status window will show the file has been imported successfully. Click *OK*.

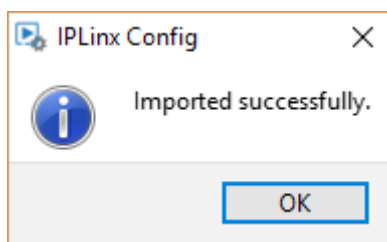

Technical Specifications

Input/Output Connections	
LAN	Two (2) 8P8C port (Shielded RJ45)
Power	One (1) 5.5 mm OD, 2.6 mm ID Threaded Barrel
RS232 Port	One (1) 6-pin Removable Terminal Block Connector
Reset Button	One (1) Recessed Microswitch
Supported Control	
Supported Baud Rates	9600 (control) and 115200 (debug)
Ethernet	100BaseT
LAN Maximum Distance	100 m (328 ft)
LAN Cable Requirements	Category 5e or greater with TIA/EIA-568B crimp pattern
Chassis and Environmental	
Construction	Black Steel
Dimensions (H x W x D)	26 mm x 93.2 mm x 138.7 mm (1.02 in x 3.67 in x 5.46 in)
Operating Temperature	0° to +40° C (+32° to +104° F)
Operating Humidity	20% to 90%, Non-condensing
Storage Temperature	-10° to +60° C (+14° to +140° F)
Storage Humidity	20% to 90%, Non-condensing
Power and Regulatory	
Power Input	12V DC 1A or 48V DC PoE (Power over Ethernet)
Power Output (RS232 port)	12V DC 0.5A
Power over Ethernet (PoE) Compatibility	802.3af Alternative B
Power Consumption	4.5 watts (10.5 watts when using 12V on RS232 port)
ESD Protection	8kV air, 4kV contact
Regulatory	FCC, CE, RoHS
Other	
Warranty	2 years
Diagnostic Indicators	Status and Power
Included Accessories	Installation Guide, Power Supply, 6-pin Removable Screw Terminal
Compatible Encoders	IPEX2001, IPEX5001
Compatible Decoders	IPEX2002, IPEX2003MV, IPEX5002

IPLinx is a brand of:



LIBERTY
AV SOLUTIONS

A SUBSIDIARY OF WESCO DISTRIBUTION, INC.

11675 Ridgeline Drive
Colorado Springs, Colorado
80921 USA
Phone: 719-260-0061
Fax: 719-260-0075
Toll-Free: 800-530-8998
Email: supportlibav@libav.com