

# **OPERATION MANUAL**

---

**FVW-700**

Video Writer

---

1<sup>st</sup> Edition

# Edition Revision History

---





Edit.	Rev.	Date	Description	Section/Page
1	-	2017/06/28	First edition	

# Precautions



---

## Important Safety Warnings



### [Power]

 Caution	Operate unit <b>only</b> at the specified supply voltage.
 Disconnect	Disconnect the power cord via the power plug only. Do <b>not</b> pull on the cable portion.
 Stop	Do <b>not</b> place or drop heavy or sharp-edged objects on the power cord. A damaged cord can cause fire or electrical shock hazards. Regularly check the power cord for excessive wear or damage to avoid possible fire / electrical hazards.
 Caution	Ensure the power cord is firmly plugged into the AC outlet.

### [Grounding]

 Caution	<b>Ensure</b> the unit is properly grounded at all times to prevent electrical shock.
 Hazard	Do <b>not</b> ground the unit to gas lines, units, or fixtures of an explosive or dangerous nature.



### [Operation]

 Hazard	Do <b>not</b> operate the unit under hazardous or potentially explosive atmospheric conditions. Doing so could result in fire, explosion, or other hazardous results.
 Hazard	Do <b>not</b> allow liquids, metal pieces, or other foreign materials to enter the unit. Doing so could result in fire, other hazards, or a unit malfunction.
 Disconnect	If a foreign material does enter the unit, turn the power off and <b>immediately</b> disconnect the power cord. Remove the material and contact an authorized service representative if damage has occurred.

### [Transportation]

 Hazard	<b>Handle</b> with care to avoid impact shock during transit, which may cause malfunction. When you need to transport the unit, use the original or suitable alternative packing material.
---	--

## [Circuitry Access]

	<p>Do <b>not</b> remove covers, panels, casing, or access the circuitry with power applied to the unit. Turn the power off and disconnect the power cord prior to removal. Internal servicing / adjustment of unit should only be performed by qualified personnel.</p>
 <p>Stop</p>	<p>Do <b>not</b> touch any parts / circuitry with a high heat factor. Capacitors can retain enough electric charge to cause mild to serious shock, even after the power has been disconnected. Capacitors associated with the power supply are especially hazardous.</p>
 <p>Hazard</p>	<p>Unit should <b>not</b> be operated or stored with cover, panels, and / or casing removed. Operating the unit with circuitry exposed could result in electric shock / fire hazards or a unit malfunction.</p>

## [Potential Hazards]

 <p>Caution</p>	<p>If abnormal odors or noises are noticed coming from the unit, immediately turn the power off and disconnect the power cord to avoid potentially hazardous conditions. If problems similar to the above occur, contact an authorized service representative <b>before</b> attempting to operate the unit again.</p>
--	---

## [Rack Mount Brackets, Ground Terminal, and Rubber Feet]

 <p>Caution</p>	<p>To rack-mount or ground the unit, or to install rubber feet, do not use screws or materials other than those supplied. Doing so may cause damage to the internal circuits or components of the unit. If you remove the rubber feet that are attached to the unit, do not reinsert the screws that secure the rubber feet.</p>
--	--

## [Consumables]

 <p>Caution</p>	<p>Consumable items that are used in the unit must be periodically replaced. For further details on which parts are consumables and when they should be replaced, refer to the specifications at the end of the Operation Manual. Since the service life of the consumables varies greatly depending on the environment in which they are used, such items should be replaced at an early date. For details on replacing consumable items, contact your dealer.</p>
--	---

## Upon Receipt

---

The FVW-700 units and their accessories are fully inspected and adjusted prior to shipment. Operation can be performed immediately upon completing all required connections and operational settings.

Check your received items against the packing lists below.

### ◆ FVW-700 Box

ITEM	QTY	REMARKS
FVW-700	1	
AC Cord	1 set	(Includes an AC cord retaining clip)
Rack Mount Brackets	1 set	EIA standard type (Includes 4 screws)
Rubber Feet	1 set	
DVI-VGA Conversion connector	1	
CD-ROM	1	FVW-700 Operation Manual (PDF) FVW-7SO Operation Manual (PDF)

## Trademarks

---

- \* **Microsoft Windows®**, **10 IoT Enterprise Operating System** is either registered trademark or trademark of Microsoft Corporation in the United States and/or other countries
- \* **NVIDIA** and **Quadro** are either registered trademarks or trademarks of NVIDIA Corporation in the United States and-or other countries.

## Installing the AC Cord Retention Clip

---

Secure the AC cord with the supplied ladder strap/retention clip assembly to prevent accidental removal from the unit.

### ◆ Installing the clip

- 1) Wrap the retention clip around the AC cord (with the anchor of the ladder strap toward the unit.)
- 2) Insert the anchor into the hole next to the AC IN socket.
- 3) Lightly fasten the clip around the AC cord.
- 4) Plug in the power cord.
- 5) Slide the clip on the ladder strap toward the plug.
- 6) Fasten the clip tightly.
- 7) Gently pull on the AC cord to ensure it is secured.

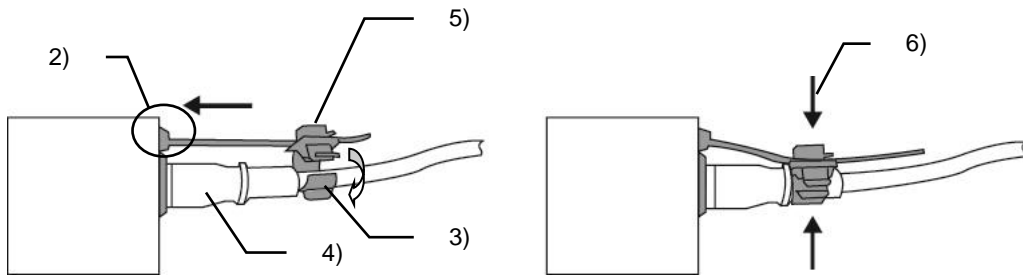

### ◆ Unplugging the AC cord

- 1) Push the tab on the retention clip up to unfasten the clip.
- 2) Push the tab on the ladder strap up and slide the clip back.
- 3) Unplug the AC cord.

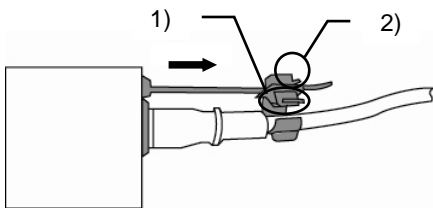

# Table of Contents

---

- 1. Prior to Starting.....8
  - 1-1. Overview .....8
  - 1-2. Features .....8
  - 1-3. Precautions on FVW-700 Use .....8
- 2. Panel Descriptions.....9
  - 2-1. Front Panel.....9
  - 2-2. Rear Panel .....10
    - 2-2-1. Alarm Connector .....11
- 3. Connection .....13
  - 3-1. Using a Touch Panel Monitor.....13
    - 3-1-1. Touch Panel Driver Installation.....13
  - 4-2. System Setting .....16
  - 4-4. Composite Out Settings .....17
  - 4-5. Saving Settings .....18
- 5. Resetting to Default .....19
- 6. Specifications and Dimensions .....20
  - 6-1. Unit Specifications.....20
- Appendix 1. How to Reset BIOS .....22
- Appendix 2. MICROSOFT SOFTWARE LICENSE TERMS .....31

# 1. Prior to Starting

---

## 1-1. Overview

---

The FVW-700 system displays lines, objects, images, and movies onto video images in real time. Creating custom icons allow you to control the application via a touch screen. It is ideal for live broadcast environments, including weather news and sports.

## 1-2. Features

---

- Draw and point in real-time over input video
- Straight line, free-hand, and pre-programmed graphic shape mode available
- Numbering, still images and animation placement over input video
- Various types of lines, thickness, edge-width and colors
- Highlight function
- DSK function - Enables and disables the Video Writer object to be output onto input video.
- Simple operation with draw tool, function, setting and background icons.
- Freely assignable custom buttons for various tools (Add, Delete, or change Properties)
- Touch panel calibration
- Chromakey function

## 1-3. Precautions on FVW-700 Use

---

When using the FVW-700, note the following points.

- Windows 10 is used and the OS is customized for FVW-700.  
Do not change OS settings.
- Do not install software programs other than specific softwares.
- Note that the C: drive of the FVW-700 is write-protected. Do not add folders and files to the C: drive. If files are saved to the C: drive, Windows OS may hang up. Although files are successfully saved to C: drive, the files will be lost when power is turned off.
- Save all folders and files to D: drive.



## 2. Panel Descriptions

### 2-1. Front Panel

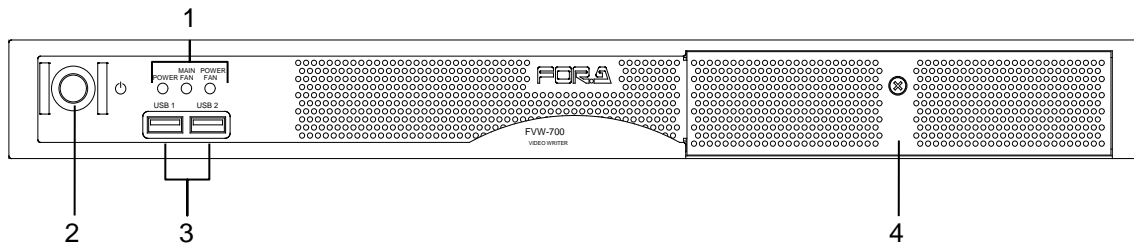

No.	Item	Description		
1	Status Indicators	POWER	Lit green	Power is applied to the unit.
			Unlit	The unit is powered off or no power cord is connected
		MAIN FAN	Unlit	Air cooling fans are operating normally.
			Lit red	One or more cooling fans failed. Turn off the power and replace the fans if necessary.
		POWER FAN	Unlit	The power unit air cooling fan is operating normally.
			Lit red	The power unit air cooling fan has failed. Turn off the power and replace the power unit if necessary.
2	POWER switch	Used to turn the unit on and off. The POWER indicator lights up when the FVW-700 is powered on. To turn off the FVW-700, close all applications and shutdown the OS. Wait <b>at least 5 seconds</b> and turn the power back on after powering off the FVW-700.		
3	USB1, USB2	For connecting USB devices such as keyboard, mouse, and other USB devices (USB3.0 Standard-A connector).		
4	Service panel	Do not open. For service maintenance only.		

#### IMPORTANT

- When MAIN FAN/POWER FAN indicators light red, one or more cooling fans failed. Turn off the power and contact your For-A agent.
- Pressing down the POWER switch for more than 5 seconds forces the power off. Apply this procedure only when problems occur. If the power is forced off while saving data, the data might be corrupted. Data corruption in such case are not covered under warranty.

## 2-2. Rear Panel

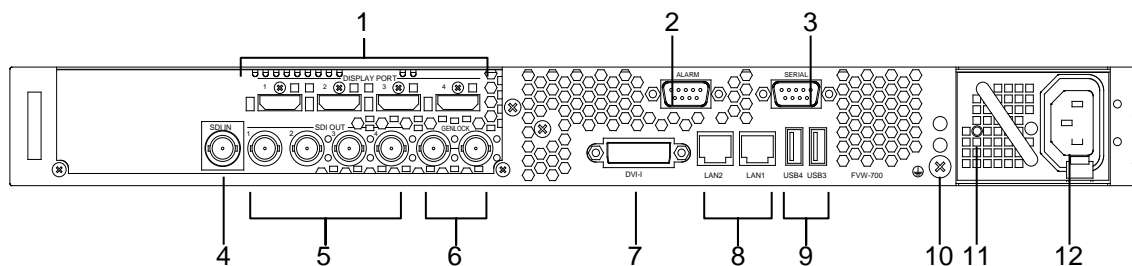

No.	Item	Description	
1	DISPLAY PORT 1-4	Connects PC monitor or touch panel monitor units using the supplied DisplayPort-DVI conversion connector. Operation GUI opens. The same screen outputs to DISPLAY PORT1-4. (DisplayPort connector)	
2	ALARM	Outputs power/fan alarm. (9-pin D-sub female)	
3	SERIAL	Connects touch panel units. (RS-232C 9-pin D-sub male)	
4	SDI IN	Inputs HD-SDI signals (BNC). Inputs background video images.	
5	SDI OUT 1-4	Outputs HD-SDI signals (BNC).	
		SDI OUT 1	Outputs background and object or object only. (Set by FVW-700 Video Writer.)
		SDI OUT 2	Outputs SDI OUT1 key signal.
		SDI OUT 3	Outputs background and object or object only. (Set by FVW-700 Video Writer.)
SDI OUT 4	Outputs SDI OUT3 key signal.		
6	GENLOCK	Inputs an external reference signal (B.B. or tri-level sync) to either of two connectors. The other connector is used for loopthrough connection and must be terminated with a 75 ohm terminating resistor when not used.	
7	DVI-I	Not used.	
8	LAN1, LAN2	Connects to a computer Ethernet port. (100BASE-TX/1000BASE-T, RJ-45)	
9	USB3, USB4	Connects USB devices such as a keyboard, mouse, and other USB devices (USB3.0 Standard-A connector)	
10	Ground Terminal	Grounds unit to protect operators against static electricity and/or electrical shock.	
11	Status Lamp	Power supply unit status lamp. Indicates the power supply is operating normally when the lamp is lit.	
12	AC IN	For connection to AC power source. (AC100V-240V 50/60Hz)	

## 2-2-1. Alarm Connector

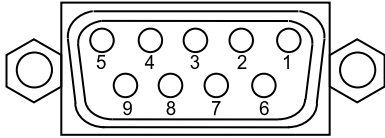

### ◆ Pin Assignment Table (9-pin D-sub, female, Inch screws)

Pin No.	Signal Name	In/Out	Description
1	+5VOUT	Out	Outputs +5V.
2	POW ALARM	Out	Outputs Power alarm. (*1)
3	FAN ALARM	Out	Outputs Fan alarm.
4	COMMON	-	Common Power and Fan alarm. (*1)
5	GND	-	Signal ground
6	NC	-	Not used
7	NC	-	Not used
8	NC	-	Not used
9	NC	-	Not used

\* Maximum current rating for +5V OUT is 200mA.

(\*1) Refer to the alarm output circuit diagram below.

### ◆ Alarm Output Circuit

Alarm outputs are relay contact circuits that operate as follows.

Normal: Common and Open

Malfunction and Power OFF: Common and Close

Pin 4 is a Common pin for both power and fan alarm.

Contact rating is [0.5A@30VDC](#).

### Alarm Output

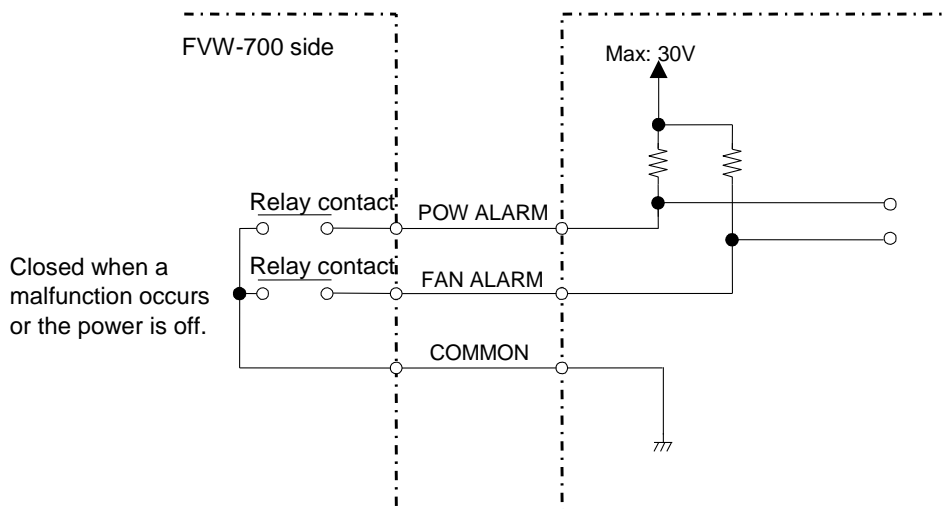

## 2-2-2. SERIAL Connector (RS-232C)

---

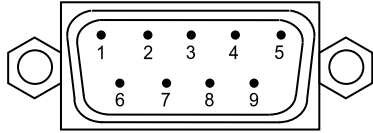

**Pin Assignment Table (9-pin D-sub male, Inch screws)**

Pin No.	Signal Name	In/Out	Description
1	DCD	In	Data carrier detection
2	RXD	In	Receive data
3	TXD	Out	Transmit data
4	DTR	Out	Data terminal ready
5	GND		Signal ground
6	DSR	In	Data set ready
7	RTS	Out	Request to send
8	CTS	In	Clear to send
9	RI	In	Ring indicator

## 3. Connection

### 3-1. Using a Touch Panel Monitor

The figure below illustrates a connection example.

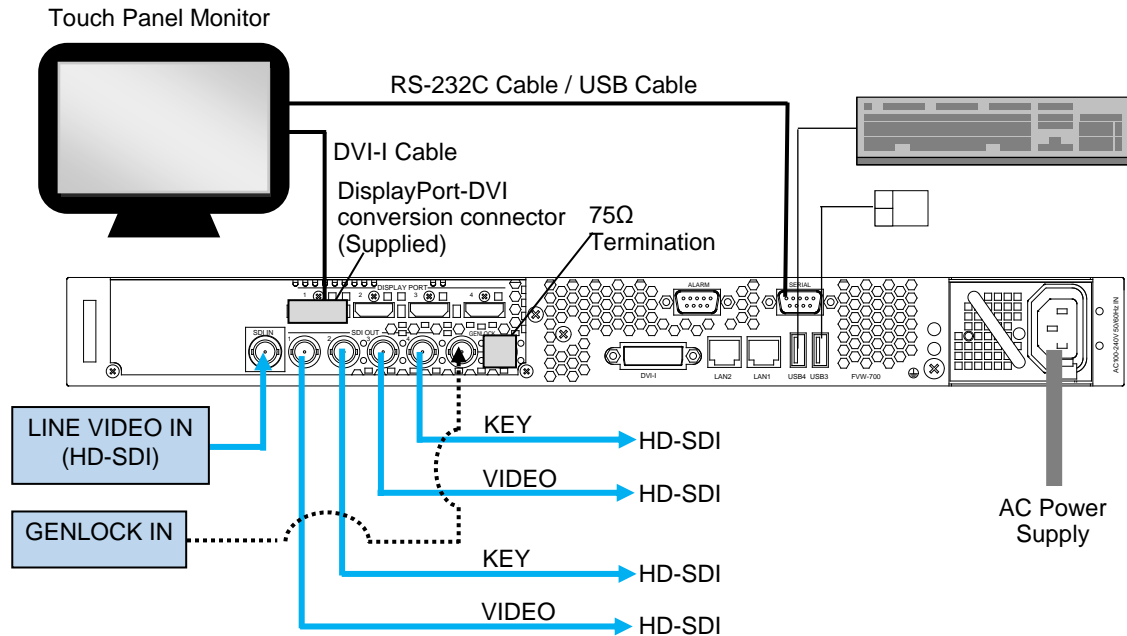

Do not connect or disconnect cables while the power is on. Doing so may damage the internal circuitry.

#### 3-1-1. Touch Panel Driver Installation

To use a touch panel screen, some monitors may require the installation of a touch panel driver. For the FVW-700, C: drive is write-protected. (Write protection needs to be disabled before driver installation.) Follow the steps below to disable the write protection, install the driver, and re-enable the write protection.

1. Click the  button in the upper right corner of the window to exit **Video Writer**.
2. Double-click the **uwf\_disable.bat** in **D:\forawork** to execute the batch file.
3. **Command Prompt** opens and shows the following messages. Press any key once on the keyboard.

```
*****
The write-protection(UWF) for the boot drive(C:) is set to enable.
The any driver cannot install when write-protection is enabled.
*****
Press any key to continue . . .
```

- The following messages appear. Check that **Disable** is shown in **Boot Command** and press any key once on the keyboard. **Command Prompt** closes and FVW-700 will restart automatically.

```
Unified Write Filter Configuration Utility version 10.0.14393
Copyright (c) Microsoft Corporation. All rights reserved.

Unified Write Filter will be disabled after system restart.
*****
The write-protection for the boot drive was set to disable.
It is reflected in the next boot. Please shutdown the Windows.
*****
Press any key to continue . . .
```

- After restarting, **install the touch panel driver for your touch panel. Be sure to use the driver built for Window 10.**
- After installing the driver, double-click the **uwf\_enable.bat** in **D:\forawork** to execute the batch file.
- Command Prompt** opens and shows the following messages. Press any key once on the keyboard.

```
*****
The write-protection(UWF) for the boot drive(C:) is set to enable.
The any driver cannot install when write-protection is enabled.
*****
Press any key to continue . . .
```

- The following messages appear. Check that **Enable** is shown in **Boot Command** and press any key once on the keyboard. **Command Prompt** closes.

```
Unified Write Filter Configuration Utility version 10.0.14393
Copyright (c) Microsoft Corporation. All rights reserved.

Unified Write Filter will be enabled after system restart.
*****
The write-protection for the boot drive was set to disable.
It is reflected in the next boot. Please shutdown the Windows.
*****
Press any key to continue . . .
```

- Windows shuts down automatically and the FVW-700 power supply turns off automatically.
- Wait for about 5 seconds and turn on the front panel power switch.

Driver installation is complete.

## 4. Using Video Writer

See FVW-7SO Operation Manual for details on Video Writer basic operations and settings.

### 4-1. Starting and Exiting Video Writer

#### ◆ Starting Video Writer

On the desktop, double-click the shortcut to **VideoWriter**.

#### NOTE

Video Writer is automatically started when the FVW-700 is powered on.  
Normally the application does not need to be manually started.

#### ◆ Exiting Video Writer

Click the **X** button in the upper right corner of the main window

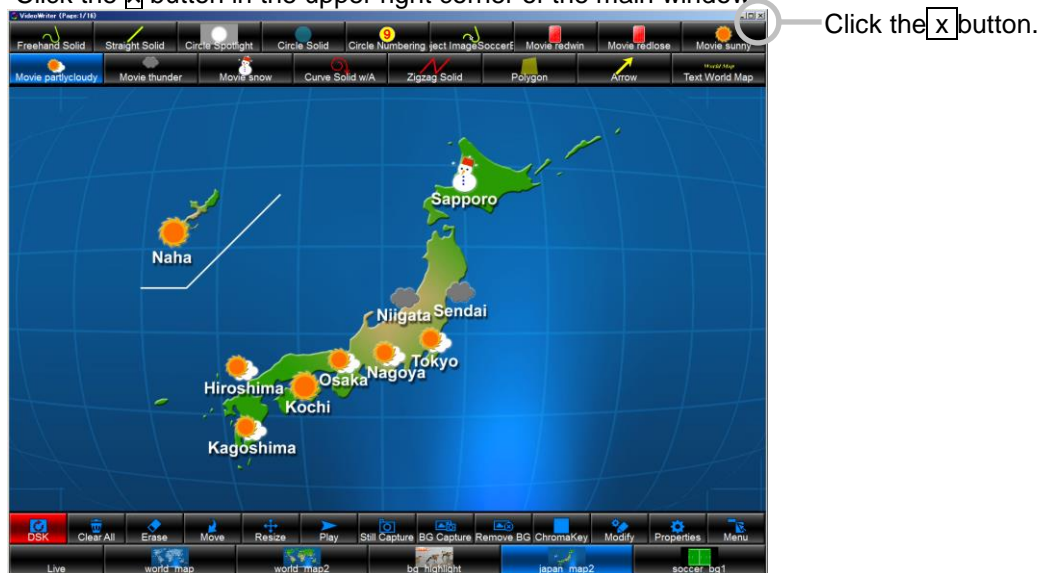

Main Window

A Shutdown operation is required before the FVW-700 is turned off. Select **Shutdown** from Windows **Start Menu**. The FVW-700 power turns off automatically.

#### IMPORTANT

Pressing the POWER switch down for more than 5 seconds forces the power off when Windows becomes inoperable because of software issues. Apply this procedure only when problem occurs.

Unplug the FVW-700 when unused for a long period of time.

## 4-2. System Setting

This section describes how to select the video format, reference signal and Lock Source, and to adjust genlock phases.

1. Click the **Menu** button in the main window.



2. Click the **Option** button.

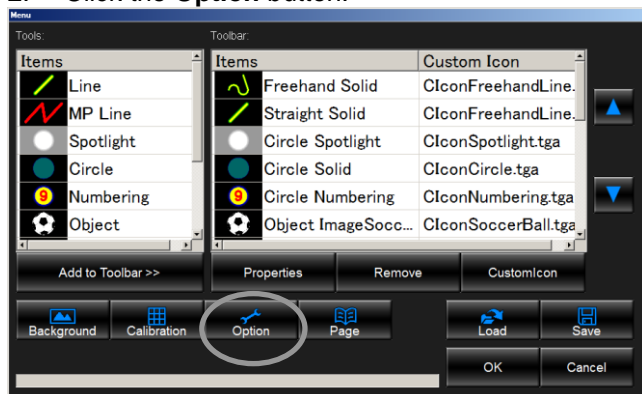

3. The screen for video option settings appears allowing you to set various settings. Click **OK** when settings are complete.



- ① Video Format selection
- ② External reference signal selection  
**Genlock:** Use of Genlock Signal.  
**Video In:** Synchronizes to SDI IN.

1. When **Genlock** is selected in ②, set ③ and ④.

- ③ Genlock Signal selection
- ④ Genlock phase adjustment



## 4-3. Background Image or Movie Selection

This section describes how to select a background image. Select a background image by clicking a background button in the Video Writer main window as shown below.

When **Live** is clicked, the movie stream that is input to FWV-700 SDI IN is applied. (Default: **Live**)

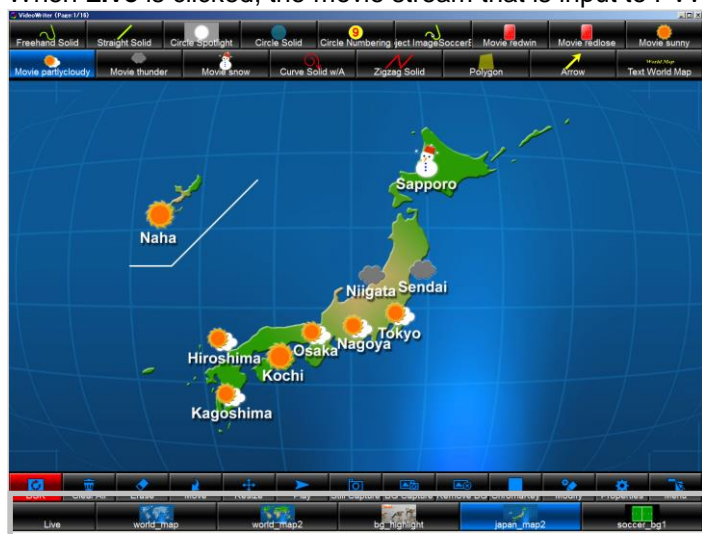

Background Buttons

## 4-4. Composite Out Settings

This section describes how to set output images and VW objects. Allows you to select output images from FWV-700 SDI OUT1 and SDI OUT3.

1. Open FWV-700 **Menu >Option > Video** dialog.

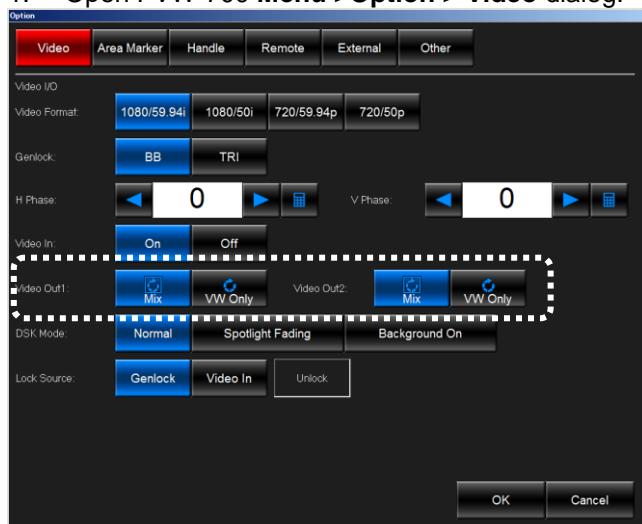

2. Set output images from SDI OUT1 in **Video OUT1**. (Default: **Mix**)  
**Mix**: Outputs background image and VW-created object composition from SDI OUT1.  
**VW Only**: Outputs VW-created objects only from SDI OUT1.
3. Set output images from SDI OUT3 in Video Out2. (Default: **Mix**)

- When set to **Mix** for Video OUT1 / Video OUT2, click the Main window **DSK** button. When the button turns red, background and VW objects composite images are out from SDI OUT1 / SDI OUT3.

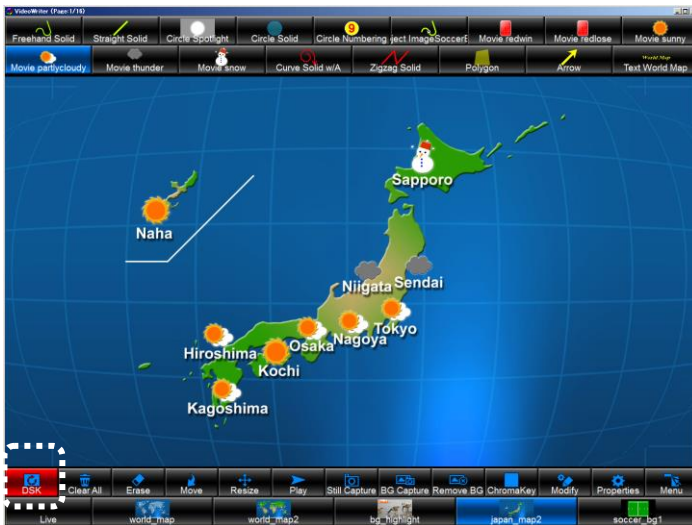

## 4-5. Saving Settings

This section describes how to save the current screen image, draw tool property settings, and background button settings into a file. File extension is **.vwf**.



- Click the **Menu** button in the Video Writer main window.
- Menu** dialog box appears. Click **Save**.
- Save As** dialog box appears. Input file name and directory and click **Save**.
- Returns to the **Menu** dialog box. Clicking **OK** closes the dialog box and current settings are saved into a file.

## 4-6. Loading Settings

This section describes how to load settings saved under Sec. 4-5. "Saving Settings."



1. Click the **Menu** button in Video Writer main window.
2. The **Menu** dialog box appears. Click **Load**.
3. An **Open** dialog box appears. Select the file (.vwf) to load and click **OK**.
4. Returns to the **Menu** dialog box. Clicking **OK** closes the dialog box and loads the selected settings.

## 5. Resetting to Default

FVW-700 settings are saved as below.

File	Settings	How to Save and Load Settings
VideoWriter.ini	Properties settings of draw tools Background button settings Option settings Safety area marker settings Video format settings External reference input settings	Click <b>OK</b> in the <b>Properties</b> dialog box. Settings are kept until the next time the application is started.
VideoWriter file (vwf file)	Current on screen image Property settings of draw tools Background button settings	Save and load the .vwf files.

To reset the above settings to default, follow the below procedure.

1. In Video Writer software, click the  button in the upper right corner of the main window to close the application.
2. To execute a batch file, double-click **default.bat** located in **C:\VideoWriter\**.
3. The command prompt is launched automatically. Once the command prompt finishes its process, the settings have been reset.
4. The settings are reset to default the next time Video Writer is run.

## 6. Specifications and Dimensions

---

### 6-1. Unit Specifications

---

Video formats	HD-SDI 1080/59.94i, 1080/50i, 720/59.94p, 720/50p
Signal Processing	4:2:2:4 digital component
Quantizing	10-bit
Video Inputs	HD-SDI: 1.5 Gbps 75Ω, BNC x 1
Video Outputs	HD-SDI: 1.5 Gbps 75Ω, BNC x 4 (2 outputs for video signal and other 2 for key source signal. SDI IN input is bypassed through SDI OUT1 output when the unit is powered off.)
Genlock Input	BB: NTSC 0.429V(p-p) / PAL 0.45V(p-p) or Tri-level Sync: 0.6V(p-p) 75Ω (termination required) or loopthrough, BNC x 1
Input Lock	±0.5H relative to genlock signal phase
I/O Delay	1 frame when the video input phase is same as that of genlock.
Interface	
DVI-I	DVI-I x 1 (1280 x 1024) (Not used)
USB	USB 3.0, Series-A type connector x 4 (2 on the front panel, 2 on the rear panel)
LAN1/LAN2	100BASE-TX/1000BASE-T, RJ-45 x 2
ALARM	9-PIN D-sub (female) x 1 ALARM: Power and fan alarm (Relay make contact output)
RS232C (SERIAL)	9-pin D-sub (male) x 1
DisplayPort1-4	DisplayPort (1.2) x 4 for control screen output
Temperature	0°C - 40°C
Humidity	20% - 80% (no condensation)
Power	100VAC - 240VAC ±10%, 50/60Hz
Consumption	120VA (117W) at 100V-120VAC 132VA (109W) at 220V - 240VAC
Dimensions	430 (W) x 44 (H) x 500 (D) mm, EIA 1RU
Weight	9 kg
Consumables (if used 24 hours a day at normal temperature)	Cooling fans: Replace every 3 years Power unit: Replace every 5 years Battery: Replace every 5 years *

\*Yearly battery replacement is recommended when unit is stored without powering on for long periods.

# 6-2. External Dimensions

(All dimensions in mm)

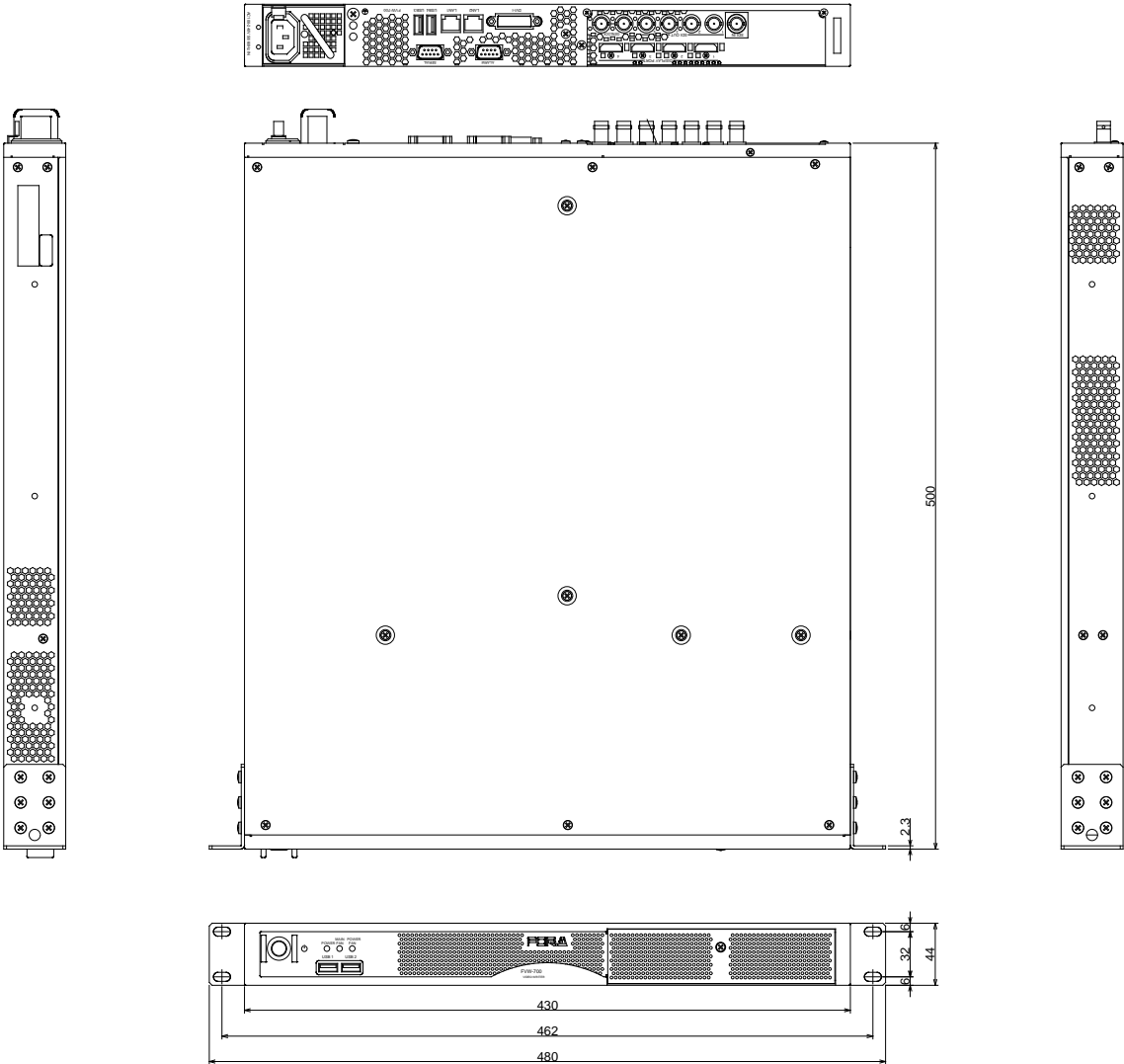

# Appendix 1. How to Reset BIOS

In case the operating system cannot be started due to the lack of battery power which backs up the BIOS settings, please consult your FOR-A reseller. Be sure to ask the FOR-A reseller to replace the battery, because some mechanical ability is required for the battery replacement.

If you urge to recover the unit, it is possible for the moment by following the procedure below to reset the BIOS.

## 1. Opening BIOS Setup Menu

1. Connect a PC monitor to the DVI-I port and a keyboard and mouse to the USB ports on the rear of the device and turn on the power

2. The screen appears as below. Press the **F2** key.

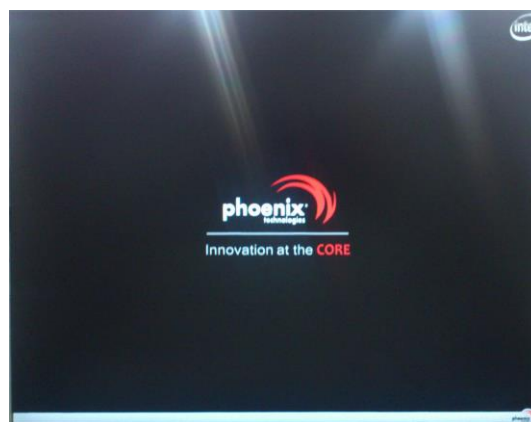

3. The Phoenix SecureCore Technology Setup screen appears.

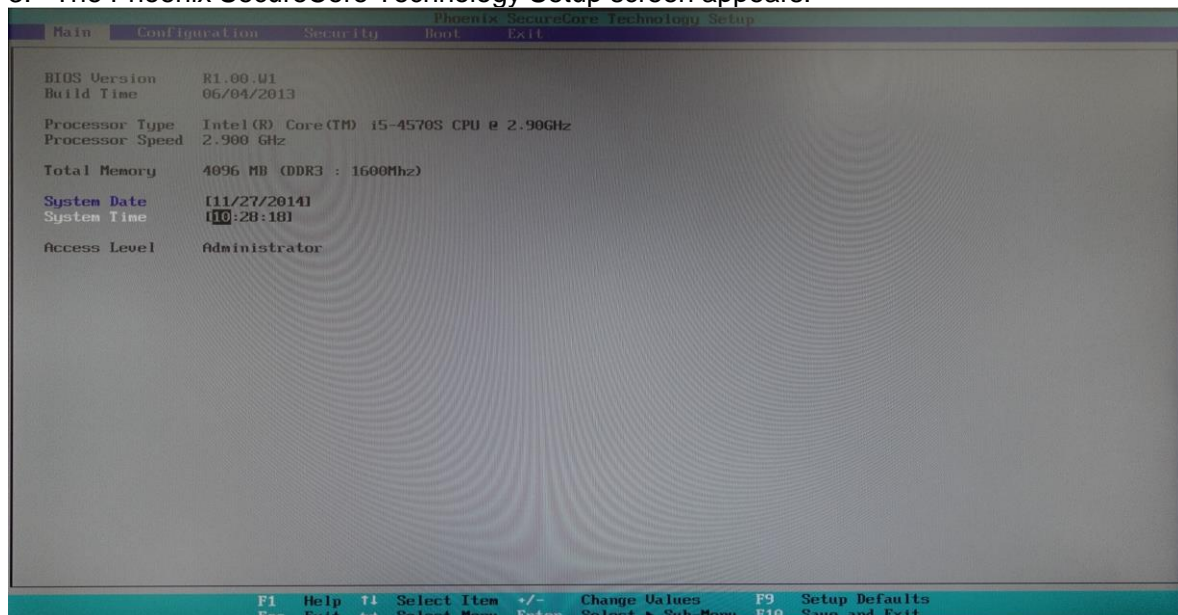

After loading default configuration settings, set the values as shown below.  
The detailed procedure is given in the following section.

Item	Menu bar	Menu Item	Submenu 1	Submenu 2	Value
(1)	Main	System Date	-	-	Current date
		System Time	-	-	Current time
(2)	Configuration	PCI/PCIE Configuration	Processor PCI Express Configuration	PEG0	Gen2
				PEG1	Gen2
				PEG2	Gen2
		Power Control Configuration	Restore AC power loss	-	Lase State
		CPU Configuration	EIST	-	Disable
		Chipset Configuration	Memory Configuration	Max TOLUD	Dynamic
		SATA Configuration	Hot Plug	-	Disable (for all items)
		Super IO Configuration	COM2 Configuration	-	RS-422
			Parallel Port Address	-	378/ IRQ7
			Parallel Port Mode	-	Standard
(3)	Boot	Boot Priority Order		1	ATA HDD0
				2	ATA HDD1

## 2. Setting Procedure

### ◆ Default configuration

- (a) On the menu bar, select **Exit** using the right and left arrow keys.
- (b) Select **Load Setup Defaults** using the up and down arrow keys, and press **Enter**.  
A confirmation message appears asking if you want to load the default configuration settings. Press **Enter**. The default configuration settings will load.

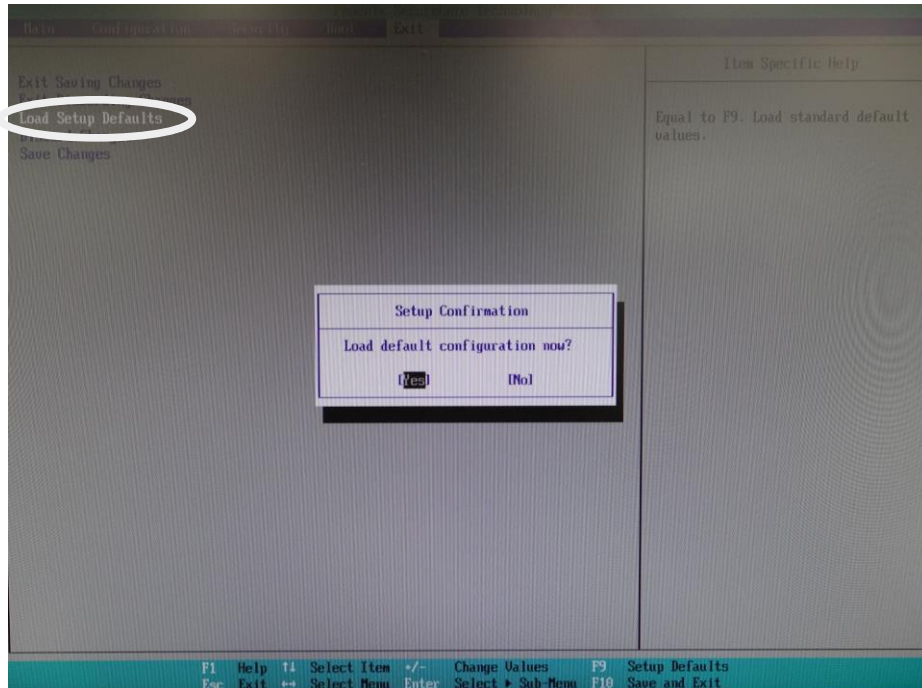

### (1) Date and time settings

- (a) On the menu bar, select **Main** using the right and left arrow keys.
- (b) Select **System Date** using the up and down arrow keys, and enter the current date using the numeric keys. Press **Enter** to confirm an entry and move the cursor to month/day/year. In the same way, set the current time under **System Time**.

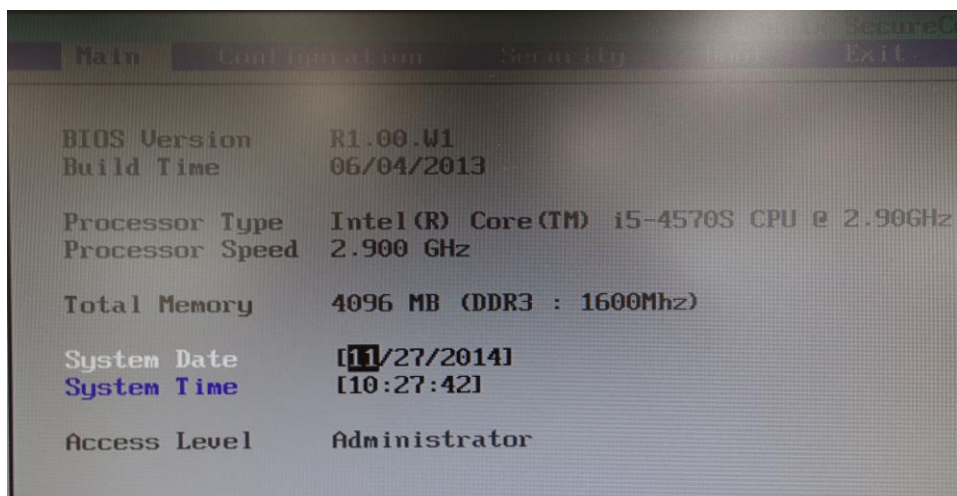



(2) Configuration menu

On the menu bar, select **Configuration** using the right and left arrow keys. The **Configuration** menu screen appears.

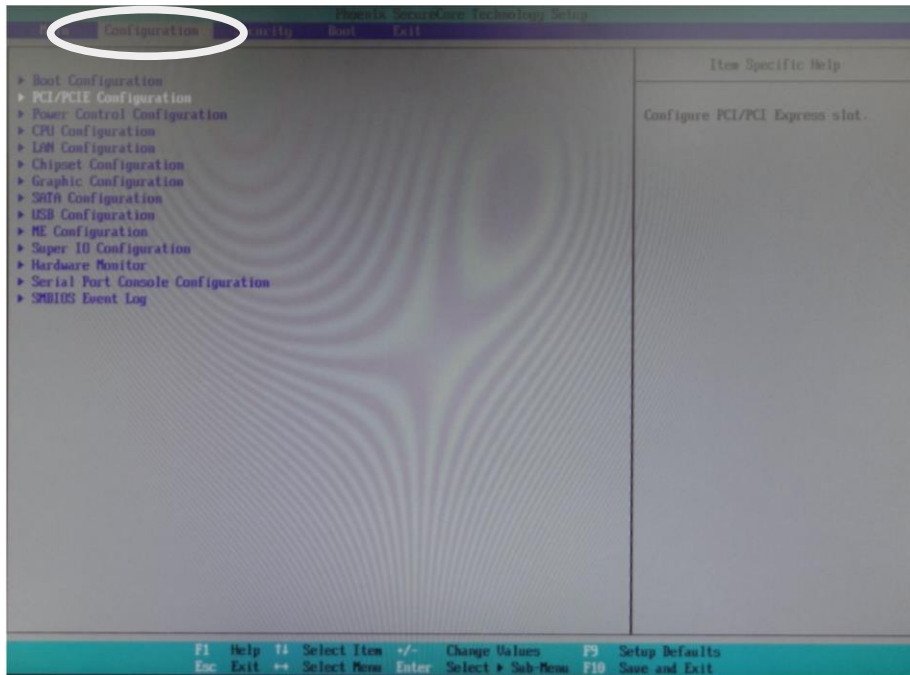

◆ **PCI/PCIE Configuration**

(a) Select the **PCI/PCIE Configuration** submenu, and press **Enter** to display the menu.

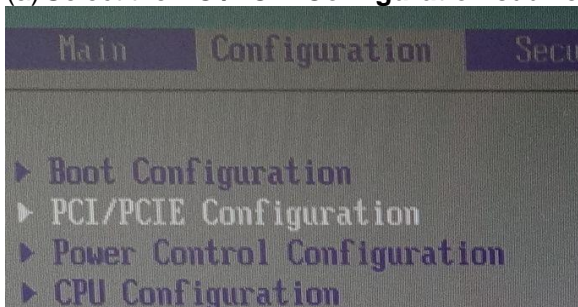

(b) Select **Processor PCI Express Configuration** using the up and down arrow keys, and press **Enter**. The Options window appears. Select **PEG0** and press **Enter**. Select **Gen2** and press **Enter**.

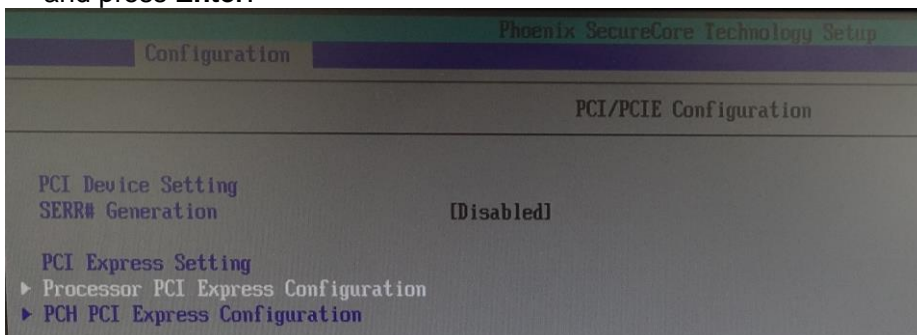

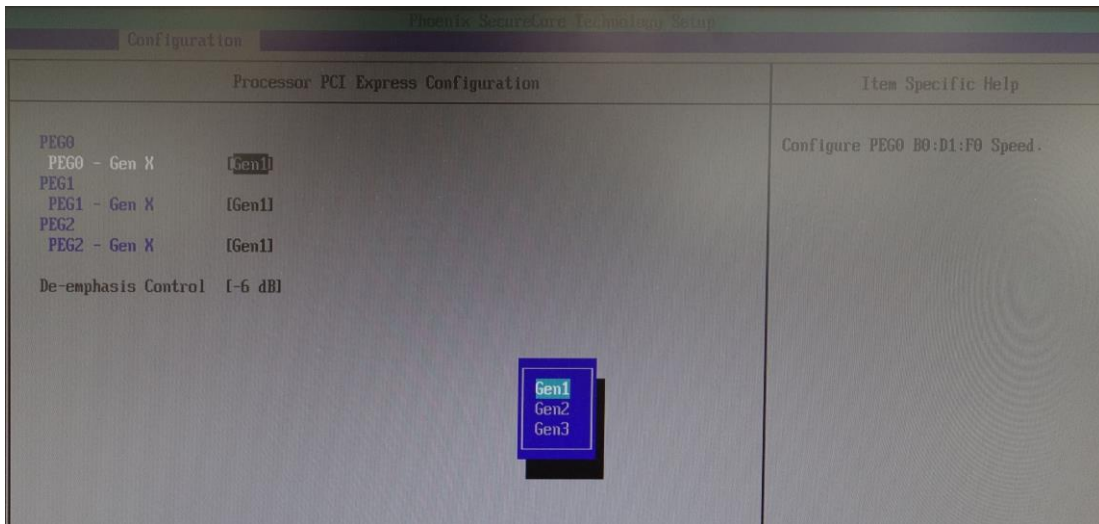

(c) In the same way, set **PEG1** and **PEG2** to **Gen2**.

◆ **Power Control Configuration**

(a) Press the **Esc** key to return to the **Configuration** menu screen. Select the **Power Control Configuration** submenu and press **Enter**.

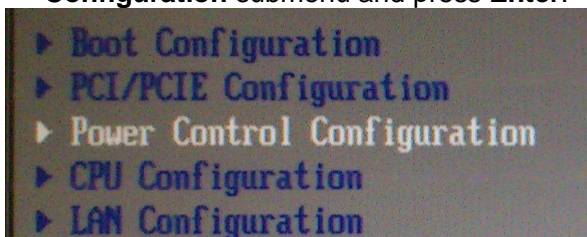

(b) Select **Restore AC power loss**, and press **Enter**. Select **Last State**, and press **Enter**.

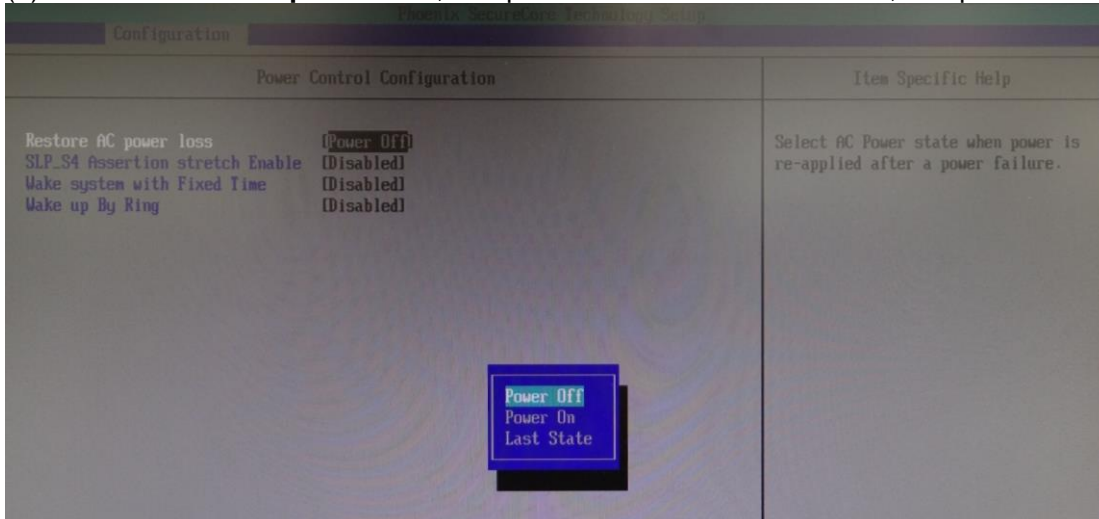

◆ **CPU Configuration**

(a) Press the **Esc** key to return to the **Configuration** menu screen. Display the **CPU Configuration** menu.

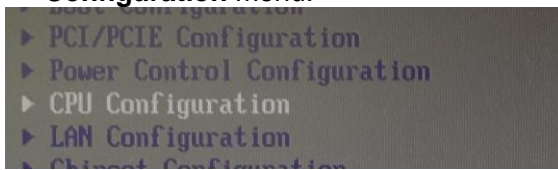

(b) Select **EIST** using the up and down arrow keys, and press **Enter**.

(c) Select **Disabled** using the up and down arrow keys, and press **Enter**.

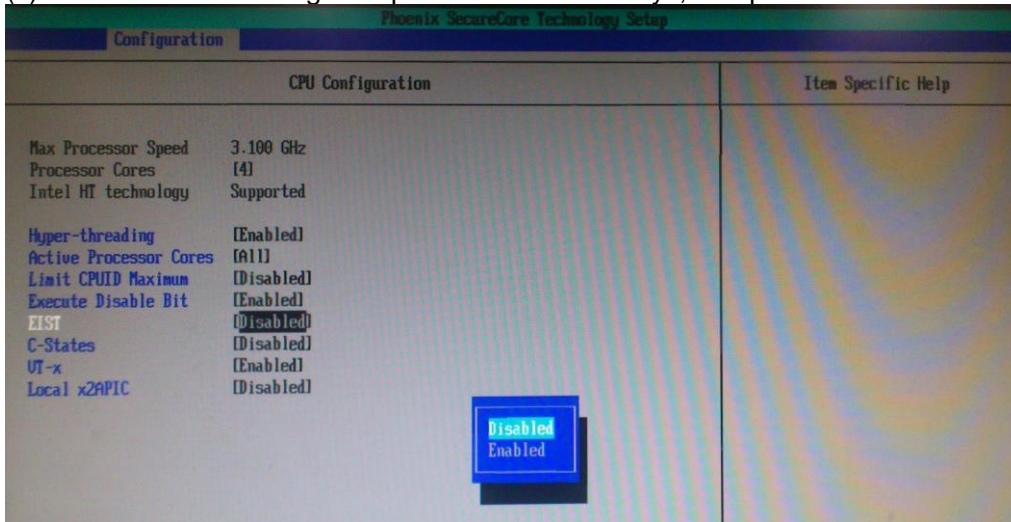

◆ **Chipset Configuration**

(a) Press the **Esc** key to return to the **Configuration** menu screen. Display the **Chipset Configuration** menu.

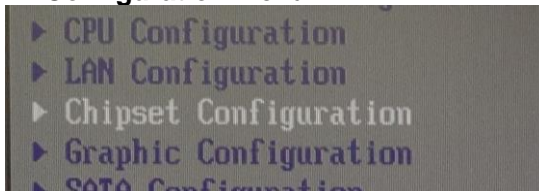

(b) Select **Memory Configuration** using the up and down arrow keys, and press **Enter**.

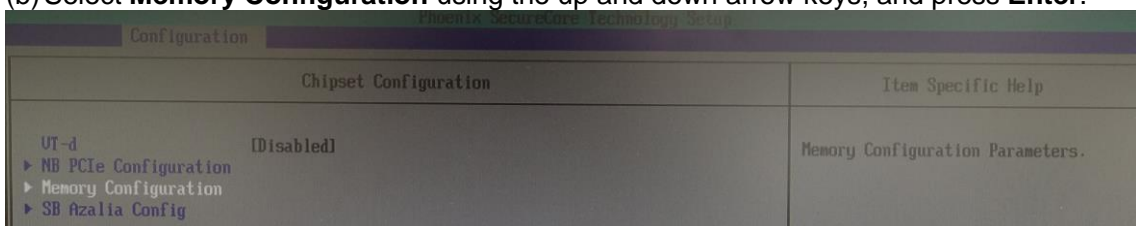

- (c) Select **Max TOLUD** using the up and down arrow keys, and press **Enter**.
- (d) Select **Dynamic** and press **Enter**.

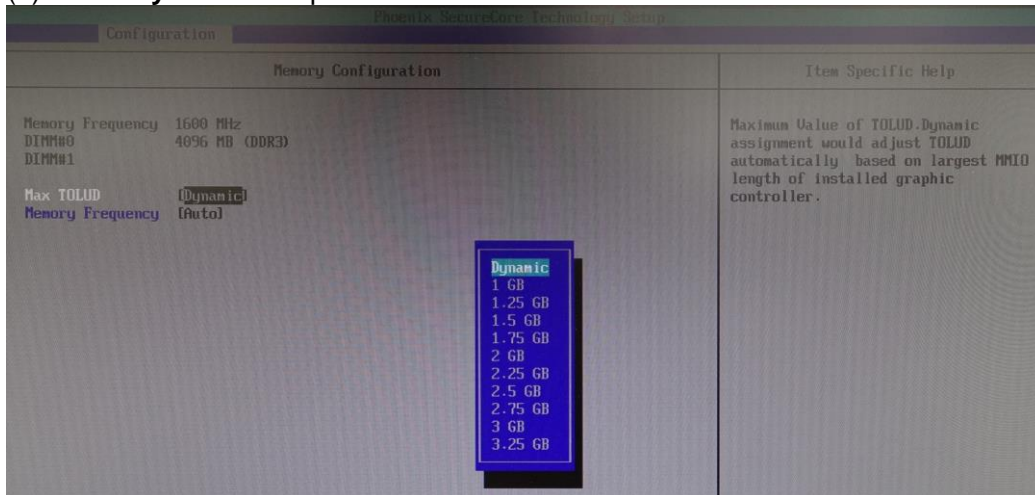

◆ **SATA Configuration**

- (a) Press the **Esc** key to return to the **Configuration** menu screen. Display the **SATA Configuration** menu.

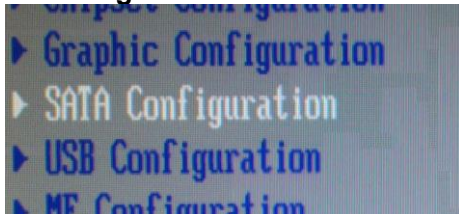

- (b) Set all **Hot Plug** settings to **Disabled**.

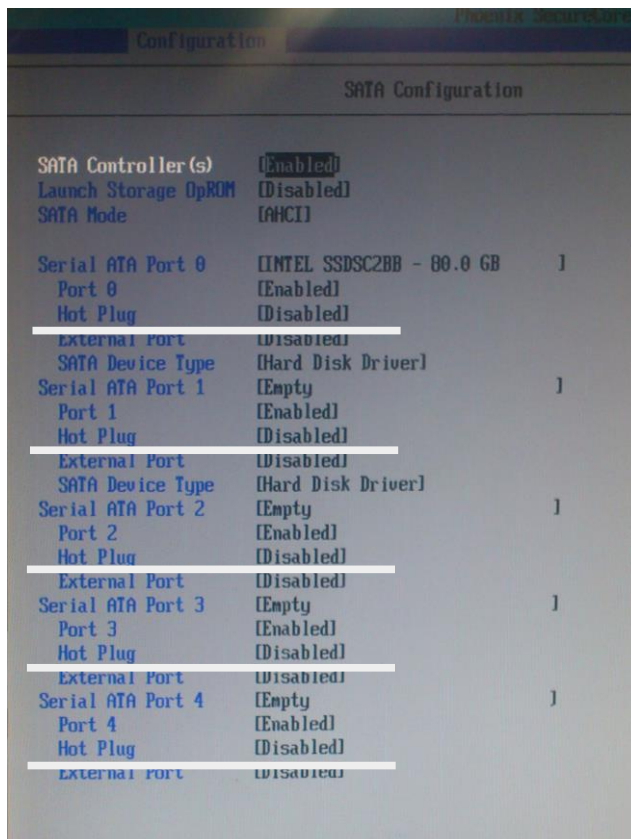

◆ **Super IO Configuration**

- (a) Press the **Esc** key to return to the **Configuration** menu screen. Display the **Super IO Configuration** menu.
- (b) Select **COM2 Configuration** using the up and down arrow keys, and press **Enter**.
- (c) Select **RS-422** using the up and down arrow keys, and press **Enter**.

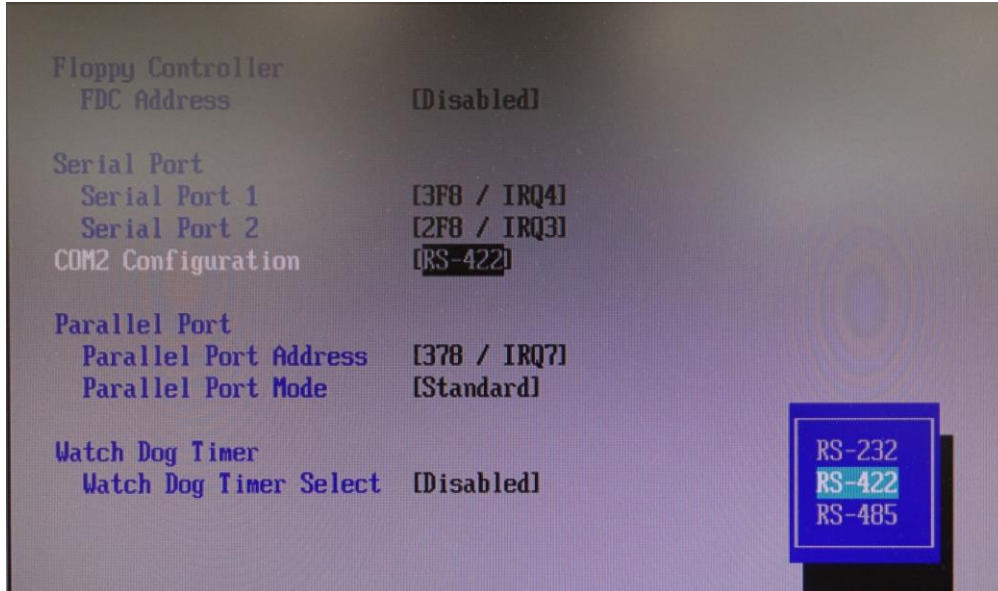

- (d) Select **Parallel Port Address** using the up and down arrow keys, and press **Enter**.
- (e) Select **378/ IRQ7** using the up and down arrow keys, and press **Enter**.

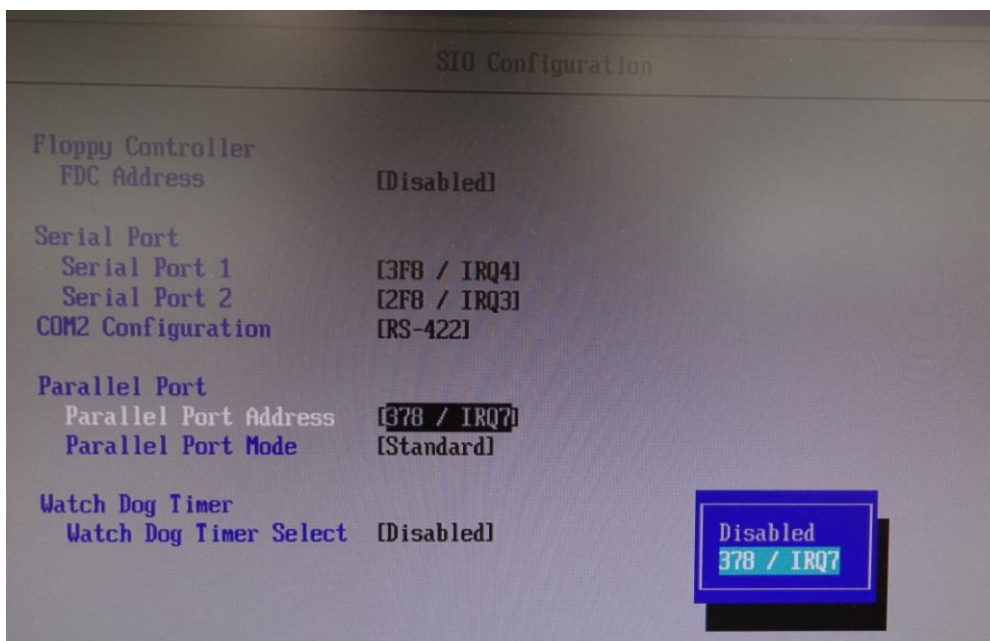

- (f) Select **Parallel Port Mode** using the up and down arrow keys, and press **Enter**.
- (g) Select **Standard** using the up and down arrow keys, and press **Enter**.

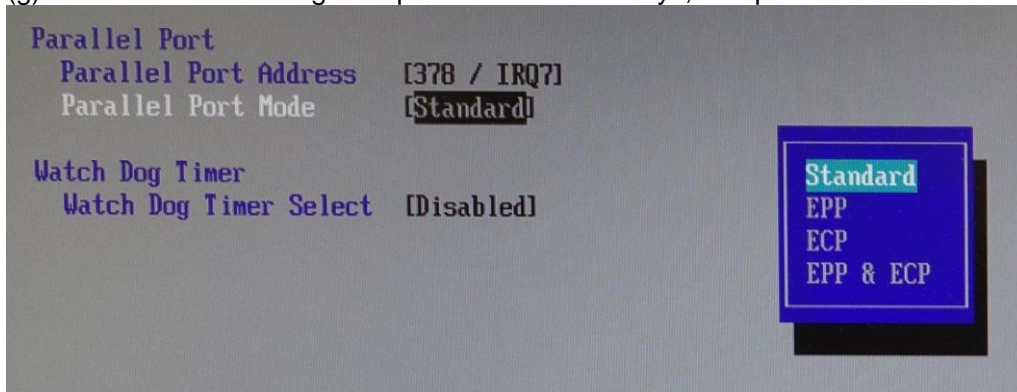

(3) Boot menu

- (a) Press the **Esc** key to return to the **Configuration** menu screen. On the menu bar, select **Boot** using the right and left arrow keys.
- (b) Under **Boot Priority Order**, set **1** to **ATA HDD0**. Use the **+** and **-** keys to change the setting.
- (c) Under **Boot Priority Order**, set **2** to **ATA HDD1**.

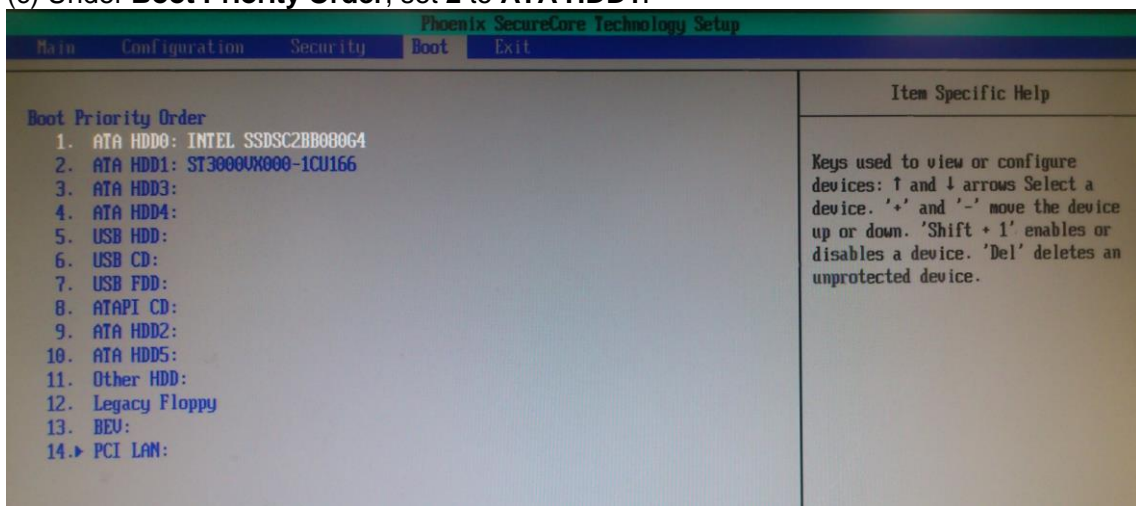

- (d) Once you have completed the settings, press the **F10** key. A confirmation message appears asking if you want to save the settings and exit the BIOS setup menus. Select **Yes** and press **Enter**. The system restarts from the BIOS boot screen.

The procedure is complete.

# Appendix 2. MICROSOFT SOFTWARE LICENSE TERMS

---

## WINDOWS 10 IOT ENTERPRISE & MOBILE (ALL EDITIONS)

---

**IF YOU LIVE IN (OR IF YOUR PRINCIPAL PLACE OF BUSINESS IS IN) THE UNITED STATES, PLEASE READ THE BINDING ARBITRATION CLAUSE AND CLASS ACTION WAIVER IN SECTION 9. IT AFFECTS HOW DISPUTES ARE RESOLVED.**

**Thank you for choosing Microsoft!**

Depending on how you obtained the Windows software, this is a license agreement between (i) you and the device manufacturer or software installer that distributes the software with your device; or (ii) you and Microsoft Corporation (or, based on where you live or if a business where your principal place of business is located, one of its affiliates) if you acquired the software from a retailer.

Microsoft is the device manufacturer for devices produced by Microsoft or one of its affiliates, and Microsoft is the retailer if you acquired the software directly from Microsoft.

This agreement describes your rights and the conditions upon which you may use the Windows software. You should review the entire agreement, including any supplemental license terms that accompany the software and any linked terms, because all of the terms are important and together create this agreement that applies to you. You can review linked terms by pasting the (aka.ms/) link into a browser window.

**By accepting this agreement or using the software, you agree to all of these terms, and consent to the transmission of certain information during activation and during your use of the software as per the privacy statement described in Section 3. If you do not accept and comply with these terms, you may not use the software or its features.** You may contact the device manufacturer or installer, or your retailer if you purchased the software directly, to determine its return policy and return the software or device for a refund or credit under that policy. You must comply with that policy, which might require you to return the software with the entire device on which the software is installed for a refund or credit, if any.

### 1. Overview.

- a. **Applicability.** This agreement applies to the Windows software that is preinstalled on your device, or acquired from a retailer and installed by you, the media on which you received the software (if any), any fonts, icons, images or sound files included with the software, and also any Microsoft updates, upgrades, supplements or services for the software, unless other terms come with them. It also applies to Windows apps developed by Microsoft that provide functionality such as mail, calendar, contacts, music and news that are included with and are a part of Windows. If this agreement contains terms regarding a feature or service not available on your device, then those terms do not apply.
- b. **Additional terms.** Depending on your device's capabilities, how it is configured, and how you use it, additional Microsoft and third party terms may apply to your use of certain features, services and apps.
  - (i) Some Windows apps provide an access point to, or rely on, online services, and the use of those services is sometimes governed by separate terms and privacy policies, such as the Microsoft Services Agreement at (aka.ms/msa). You can view these terms and policies by looking at the service terms of use or the app's settings, as applicable; please read them. The services may not be available in all regions.
  - (ii) The manufacturer or installer may also preinstall apps, which will be subject to separate license terms.

- (iii) The software may include third party software such as Adobe Flash Player that is licensed under its own terms. You agree that your use of Adobe Flash Player is governed by the license terms for Adobe Systems Incorporated at ([aka.ms/adobeflash](http://aka.ms/adobeflash)). Adobe and Flash are either registered trademarks or trademarks of Adobe Systems Incorporated in the United States and/or other countries.
- (iv) The software may include third party programs that are licensed to you under this agreement, or under their own terms. License terms, notices and acknowledgements, if any, for the third party program can be view at ([aka.ms/thirdpartynotices](http://aka.ms/thirdpartynotices)).

## 2. Installation and Use Rights.

- a. **License.** The software license is permanently assigned to the device with which you acquired the software. You may only use the software on that device.
- b. **Device.** In this agreement, “device” means a physical hardware system) with an internal storage device capable of running the software. A hardware partition or blade is considered to be a device.
- c. **Restrictions.** The manufacturer or installer and Microsoft reserve all rights (such as rights under intellectual property laws) not expressly granted in this agreement. For example, this license does not give you any right to, and you may not:
  - (i) use or virtualize features of the software separately;
  - (ii) publish, copy (other than the permitted backup copy), rent, lease, or lend the software;
  - (iii) transfer the software (except as permitted by this agreement);
  - (iv) work around any technical restrictions or limitations in the software;
  - (v) use the software as server software, for commercial hosting, make the software available for simultaneous use by multiple users over a network, install the software on a server and allow users to access it remotely, or install the software on a device for use only by remote users;
  - (vi) reverse engineer, decompile, or disassemble the software, or attempt to do so, except and only to the extent that the foregoing restriction is (a) permitted by applicable law; (b) permitted by licensing terms governing the use of open source components that may be included with the software; or (c) required to debug changes to any libraries licensed under the GNU Lesser General Public License which are included with and linked to by the software; and
  - (vii) when using Internet-based features you may not use those features in any way that could interfere with anyone else’s use of them, or to try to gain access to or use any service, data, account, or network, in an unauthorized manner.
- d. **Multi use scenarios.**
  - (i) **Multiple versions.** If when acquiring the software, you were provided with multiple versions (such as 32-bit and 64-bit versions), you may install and activate only one of those versions at a time.
  - (ii) **Multiple or pooled connections.** Hardware or software you use to multiplex or pool connections, or reduce the number of devices or users that access or use the software, does not reduce the number of licenses you need. You may only use such hardware or software if you have a license for each instance of the software you are using.



- (iii) **Device connections.** You may allow up to 20 other devices to access the software installed on the licensed device for the purpose of using the following software features: file services, print services, Internet information services, and Internet connection sharing and telephony services on the licensed device. The 20 connection limit applies to devices that access the software indirectly through “multiplexing” or other software or hardware that pools connections. You may allow any number of devices to access the software on the licensed device to synchronize data between devices. This section does not mean, however, that you have the right to install the software, or use the primary function of the software (other than the features listed in this section), on any of these other devices.
- (iv) **Remote access.** Users may access the licensed device from another device using remote access technologies, but only on devices separately licensed to run the same or higher edition of this software.
- (v) **Remote assistance.** You may use remote assistance technologies to share an active session without obtaining any additional licenses for the software. Remote assistance allows one user to connect directly to another user’s computer, usually to correct problems.
- (vi) **POS application.** If the software is installed on a retail point of service device, you may use the software with a point of service application (“POS Application”). A POS Application is a software application which provides only the following functions: (i) process sales and service transactions, scan and track inventory, record and/or transmit customer information, and perform related management functions, and/or (ii) provide information directly and indirectly to customers about available products and services. You may use other programs with the software as long as the other programs: (i) directly support the manufacturer’s specific use for the device, or (ii) provide system utilities, resource management, or anti-virus or similar protection. For clarification purposes, an automated teller machine (“ATM”) is not a retail point of service device.
- (vii) **Cloud Computing Devices.** If your device uses Internet browsing functionality to connect to and access cloud hosted applications: (i) no desktop functions may run locally on the device, and (ii) any files that result from the use of the desktop functions may not be permanently stored on the system. “Desktop functions,” as used in this agreement, means a consumer or business task or process performed by a computer or computing device. This includes but is not limited to email, word processing, spreadsheets, database, scheduling, network or internet browsing and personal finance.
- (viii) **Desktop Functions.** If your system performs desktop functions, then you must ensure that they: (i) are only used to support the application, and (ii) operate only when used with the application.

**e. Specific Use.** The manufacturer designed the licensed device for a specific use. You may only use the software for that use.

**f. Backup copy.** You may make a single copy of the software for backup purposes, and may also use that backup copy to transfer the software if it was acquired as stand-alone software, as described below.

**3. Privacy; Consent to Use of Data.** Your privacy is important to us. Some of the software features send or receive information when using those features. Many of these features can be switched off in the user interface, or you can choose not to use them. By accepting this agreement and using the software you agree that Microsoft may collect, use, and disclose the information as described in the Microsoft Privacy Statement available at ([aka.ms/privacy](https://aka.ms/privacy)), and as may be described in the user interface associated with the software features.

#### 4. Transfer

- a. **Software preinstalled on device.** If you acquired the software preinstalled on a device, you may transfer the license to use the software directly to another user, only with the licensed device. The transfer must include the software and, if provided with the device, an authentic Windows label including the product key. Before any permitted transfer, the other party must agree that this agreement applies to the transfer and use of the software.
  - b. **Stand-alone software.** If you acquired the software as stand-alone software, you may transfer the software to another device that belongs to you. You may also transfer the software to a device owned by someone else if (i) you are the first licensed user of the software and (ii) the new user agrees to the terms of this agreement. You may use the backup copy we allow you to make or the media that the software came on to transfer the software. Every time you transfer the software to a new device, you must remove the software from the prior device. You may not transfer the software to share licenses between devices.
5. **Authorized Software and Activation.** You are authorized to use this software only if you are properly licensed and the software has been properly activated with a genuine product key or by other authorized method. When you connect to the Internet while using the software, the software will automatically contact Microsoft or its affiliate to confirm the software is genuine and the license is associated with the licensed device. You can also activate the software manually by Internet or telephone. In either case, transmission of certain information will occur, and Internet, telephone and SMS service charges may apply. During activation (or reactivation that may be triggered by changes to your device's components), the software may determine that the installed instance of the software is counterfeit, improperly licensed or includes unauthorized changes. If activation fails the software will attempt to repair itself by replacing any tampered Microsoft software with genuine Microsoft software. You may also receive reminders to obtain a proper license for the software. Successful activation does not confirm that the software is genuine or properly licensed. You may not bypass or circumvent activation. To help determine if your software is genuine and whether you are properly licensed, see ([aka.ms/genuine](http://aka.ms/genuine)). Certain updates, support, and other services might only be offered to users of genuine Microsoft software.
  6. **Updates.** You may obtain updates only from Microsoft or authorized sources, and Microsoft may need to update your system to provide you with those updates. The software periodically checks for system and app updates, and may download and install them for you. To the extent automatic updates are enabled on your device, by accepting this agreement, you agree to receive these types of automatic updates without any additional notice.
  7. **Geographic and Export Restrictions.** If your software is restricted for use in a particular geographic region, then you may activate the software only in that region. You must also comply with all domestic and international export laws and regulations that apply to the software, which include restrictions on destinations, end users, and end use. For further information on geographic and export restrictions, visit ([aka.ms/georestrict](http://aka.ms/georestrict)) and ([aka.ms/exporting](http://aka.ms/exporting)).
  8. **Support and Refund Procedures.** For the software generally, contact the device manufacturer or installer for support options. Refer to the support number provided with the software. For updates and supplements obtained directly from Microsoft, Microsoft may provide limited support services for properly licensed software as described at ([aka.ms/mssupport](http://aka.ms/mssupport)). If you are seeking a refund, contact the manufacturer or installer to determine its refund policies. You must comply with those policies, which might require you to return the software with the entire device on which the software is installed for a refund.
  9. **Binding Arbitration and Class Action Waiver if You Live in (or if a Business Your Principal Place of Business is in) the United States.**

We hope we never have a dispute, but if we do, you and we agree to try for 60 days to resolve it informally. If we can't, you and we agree to **binding individual arbitration before the American Arbitration Association ("AAA") under the Federal Arbitration Act ("FAA"), and not to sue in court in front of a judge or jury**. Instead, a neutral arbitrator will decide and the arbitrator's decision will be final except for a limited right of appeal under the FAA. **Class action lawsuits, class-wide arbitrations, private attorney-general actions, and any other proceeding where someone acts in a representative capacity aren't allowed. Nor is combining individual proceedings without the consent of all parties.** "We," "our," and "us" includes Microsoft, the device manufacturer, and software installer.

- a. **Disputes covered—everything except IP.** The term "dispute" is as broad as it can be. It includes any claim or controversy between you and the manufacturer or installer, or you and Microsoft, concerning the software, its price, or this agreement, under any legal theory including contract, warranty, tort, statute, or regulation, **except disputes relating to the enforcement or validity of your, your licensors', our, or our licensors' intellectual property rights.**
- b. **Mail a Notice of Dispute first.** If you have a dispute and our customer service representatives can't resolve it, send a Notice of Dispute by U.S. Mail to the manufacturer or installer, ATTN: LEGAL DEPARTMENT. If your dispute is with Microsoft, mail it to Microsoft Corporation, ATTN: LCA ARBITRATION, One Microsoft Way, Redmond, WA 98052-6399. Tell us your name, address, how to contact you, what the problem is, and what you want. A form is available at ([aka.ms/disputeform](https://aka.ms/disputeform)). We'll do the same if we have a dispute with you. After 60 days, you or we may start an arbitration if the dispute is unresolved.
- c. **Small claims court option.** Instead of mailing a Notice of Dispute, and if you meet the court's requirements, you may sue us in small claims court in your county of residence (or if a business your principal place of business) or our principal place of business—King County, Washington USA if your dispute is with Microsoft. We hope you'll mail a Notice of Dispute and give us 60 days to try to work it out, but you don't have to before going to small claims court.
- d. **Arbitration procedure.** The AAA will conduct any arbitration under its Commercial Arbitration Rules (or if you are an individual and use the software for personal or household use, or if the value of the dispute is \$75,000 USD or less whether or not you are an individual or how you use the software, its Consumer Arbitration Rules). For more information, see ([aka.ms/adr](https://aka.ms/adr)) or call 1-800-778-7879. To start an arbitration, submit the form available at ([aka.ms/arbitration](https://aka.ms/arbitration)) to the AAA; mail a copy to the manufacturer or installer (or to Microsoft if your dispute is with Microsoft). In a dispute involving \$25,000 USD or less, any hearing will be telephonic unless the arbitrator finds good cause to hold an in-person hearing instead. Any in-person hearing will take place in your county of residence (of if a business your principal place of business) or our principal place of business—King County, Washington if your dispute is with Microsoft. You choose. The arbitrator may award the same damages to you individually as a court could. The arbitrator may award declaratory or injunctive relief only to you individually to satisfy your individual claim.
- e. **Arbitration fees and payments.**
  - (i) **Disputes involving \$75,000 USD or less.** The manufacturer or installer (or Microsoft if your dispute is with Microsoft) will promptly reimburse your filing fees and pay the AAA's and arbitrator's fees and expenses. If you reject our last written settlement offer made before the arbitrator was appointed, your dispute goes all the way to an arbitrator's decision (called an "award"), and the arbitrator awards you more than this last written offer, the manufacturer or installer (or Microsoft if your dispute is with Microsoft) will: (1) pay the greater of the award or \$1,000

USD; (2) pay your reasonable attorney's fees, if any; and (3) reimburse any expenses (including expert witness fees and costs) that your attorney reasonably accrues for investigating, preparing, and pursuing your claim in arbitration. The arbitrator will determine the amounts unless you and we agree on them.

- (ii) **Disputes involving more than \$75,000 USD.** The AAA rules will govern payment of filing fees and the AAA's and arbitrator's fees and expenses.
  - (iii) **Disputes involving any amount.** If you start an arbitration we won't seek our AAA or arbitrator's fees and expenses, or your filing fees we reimbursed, unless the arbitrator finds the arbitration frivolous or brought for an improper purpose. If we start an arbitration we will pay all filing, AAA, and arbitrator's fees and expenses. We won't seek our attorney's fees or expenses from you in any arbitration. Fees and expenses are not counted in determining how much a dispute involves.
- f. **Must file within one year.** You and we must file in small claims court or arbitration any claim or dispute (except intellectual property disputes — see Section 9.a.) within one year from when it first could be filed. Otherwise, it's permanently barred.
  - g. **Severability.** If the class action waiver is found to be illegal or unenforceable as to all or some parts of a dispute, those parts won't be arbitrated but will proceed in court, with the rest proceeding in arbitration. If any other provision of Section 9 is found to be illegal or unenforceable, that provision will be severed but the rest of Section 9 still applies.
  - h. **Conflict with AAA rules.** This agreement governs if it conflicts with the AAA's Commercial Arbitration Rules or Consumer Arbitration Rules.
  - i. **Microsoft as party or third-party beneficiary.** If Microsoft is the device manufacturer or if you acquired the software from a retailer, Microsoft is a party to this agreement. Otherwise, Microsoft is not a party but is a third-party beneficiary of your agreement with the manufacturer or installer to resolve disputes through informal negotiation and arbitration.
- 10. Governing Law.** The laws of the state or country where you live (or if a business where your principal place of business is located) govern all claims and disputes concerning the software, its price, or this agreement, including breach of contract claims and claims under state consumer protection laws, unfair competition laws, implied warranty laws, for unjust enrichment, and in tort, regardless of conflict of law principles. In the United States, the FAA governs all provisions relating to arbitration.
- 11. Consumer Rights, Regional Variations.** This agreement describes certain legal rights. You may have other rights, including consumer rights, under the laws of your state or country. You may also have rights with respect to the party from which you acquired the software. This agreement does not change those other rights if the laws of your state or country do not permit it to do so. For example, if you acquired the software in one of the below regions, or mandatory country law applies, then the following provisions apply to you:
- a. **Australia.** References to "Limited Warranty" are references to the express warranty provided by Microsoft or the manufacturer or installer. This warranty is given in addition to other rights and remedies you may have under law, including your rights and remedies in accordance with the statutory guarantees under the Australian Consumer Law.

In this section, "goods" refers to the software for which Microsoft or the manufacturer or installer provides the express warranty. Our goods come with guarantees that cannot be excluded under the Australian Consumer Law. You are entitled to a replacement or refund for a major failure and compensation for any other reasonably foreseeable loss or damage. You are also entitled to have the goods repaired or replaced if the goods fail to be of acceptable quality and the failure does not amount to a major failure.

- b. **Canada.** You may stop receiving updates on your device by turning off Internet access. If and when you re-connect to the Internet, the software will resume checking for and installing updates.
- c. **European Union.** The academic use restriction in Section 12.d(i) below does not apply in the jurisdictions listed on this site: ([aka.ms/academicuse](http://aka.ms/academicuse)).
- d. **Germany and Austria.**
  - (i) **Warranty.** The properly licensed software will perform substantially as described in any Microsoft materials that accompany the software. However, the manufacturer or installer, and Microsoft, give no contractual guarantee in relation to the licensed software.
  - (ii) **Limitation of Liability.** In case of intentional conduct, gross negligence, claims based on the Product Liability Act, as well as, in case of death or personal or physical injury, the manufacturer or installer, or Microsoft is liable according to the statutory law.

Subject to the preceding sentence, the manufacturer or installer, or Microsoft will only be liable for slight negligence if the manufacturer or installer or Microsoft is in breach of such material contractual obligations, the fulfillment of which facilitate the due performance of this agreement, the breach of which would endanger the purpose of this agreement and the compliance with which a party may constantly trust in (so-called "cardinal obligations"). In other cases of slight negligence, the manufacturer or installer or Microsoft will not be liable for slight negligence.
- e. **Other regions.** See ([aka.ms/variations](http://aka.ms/variations)) for a current list of regional variations

## 12. Additional Notices.

- a. **Networks, data and Internet usage.** Some features of the software and services accessed through the software may require your device to access the Internet. Your access and usage (including charges) may be subject to the terms of your cellular or internet provider agreement. Certain features of the software may help you access the Internet more efficiently, but the software's usage calculations may be different from your service provider's measurements. You are always responsible for (i) understanding and complying with the terms of your own plans and agreements, and (ii) any issues arising from using or accessing networks, including public/open networks. You may use the software to connect to networks, and to share access information about those networks, only if you have permission to do so.
- b. **H.264/AVC and MPEG-4 visual standards and VC-1 video standards.** The software may include H.264/MPEG-4 AVC and/or VC-1 decoding technology. MPEG LA, L.L.C. requires this notice:

THIS PRODUCT IS LICENSED UNDER THE AVC, THE VC-1, AND THE MPEG-4 PART 2 VISUAL PATENT PORTFOLIO LICENSES FOR THE PERSONAL AND NON-COMMERCIAL USE OF A CONSUMER TO (i) ENCODE VIDEO IN COMPLIANCE WITH THE ABOVE STANDARDS ("VIDEO STANDARDS") AND/OR (ii) DECODE AVC, VC-1, AND MPEG-4 PART 2 VIDEO THAT WAS ENCODED BY A CONSUMER ENGAGED IN A PERSONAL AND NON-COMMERCIAL ACTIVITY AND/OR WAS OBTAINED FROM A VIDEO PROVIDER LICENSED TO PROVIDE SUCH VIDEO. NO LICENSE IS GRANTED OR SHALL BE IMPLIED FOR ANY OTHER USE. ADDITIONAL INFORMATION MAY BE OBTAINED FROM MPEG LA, L.L.C. SEE [WWW.MPEGLA.COM](http://WWW.MPEGLA.COM)
- c. **Malware protection.** Microsoft cares about protecting your device from malware. The software will turn on malware protection if other protection is not installed or has

expired. To do so, other antimalware software will be disabled or may have to be removed.

- d. Limited rights versions.** If the software version you acquired is marked or otherwise intended for a specific or limited use, then you may only use it as specified. You may use other programs with the software as long as the other programs directly support the manufacturer's specific use for the device, or provide system utilities, resource management, or anti-virus or similar protection.
- (i) **Academic.** For academic use, you must be a student, faculty or staff of an educational institution at the time of purchase.
  - (ii) **Evaluation.** For evaluation (or test or demonstration) use, you may not sell the software, use it in a live operating environment, or use it after the evaluation period. Notwithstanding anything to the contrary in this Agreement, evaluation software is provided "AS IS".
  - (iii) **NFR.** You may not sell software marked as "NFR" or "Not for Resale".
- 13. Entire Agreement.** This agreement (together with the printed paper license terms or other terms accompanying any software supplements, updates, and services that are provided by the manufacturer or installer, or Microsoft, and that you use), and the terms contained in web links listed in this agreement, are the entire agreement for the software and any such supplements, updates, and services (unless the manufacturer or installer, or Microsoft, provides other terms with such supplements, updates, or services). You can review this agreement after your software is running by going to [aka.ms/useterms](https://aka.ms/useterms) or going to Settings - System - About within the software. You can also review the terms at any of the links in this agreement by typing the URLs into a browser address bar, and you agree to do so. You agree that you will read the terms before using the software or services, including any linked terms. You understand that by using the software and services, you ratify this agreement and the linked terms. There are also informational links in this agreement. The links containing notices and binding terms are:
- [Windows 10 Privacy Statement \(aka.ms/privacy\)](https://aka.ms/privacy)
  - [Microsoft Services Agreement \(aka.ms/msa\)](https://aka.ms/msa)
  - [Adobe Flash Player License Terms \(aka.ms/adobeflash\)](https://aka.ms/adobeflash)

\*\*\*\*\*

**NO WARRANTY**

THE SOFTWARE ON YOUR DEVICE (INCLUDING THE APPS) IS LICENSED “AS IS.” TO THE MAXIMUM EXTENT PERMITTED BY YOUR LOCAL LAWS, YOU BEAR THE ENTIRE RISK AS TO THE SOFTWARE’S QUALITY AND PERFORMANCE. SHOULD IT PROVE DEFECTIVE, YOU ASSUME THE ENTIRE COST OF ALL SERVICING OR REPAIR. NEITHER THE DEVICE MANUFACTURER NOR MICROSOFT GIVES ANY EXPRESS WARRANTIES, GUARANTEES, OR CONDITIONS FOR THE SOFTWARE. TO THE EXTENT PERMITTED UNDER YOUR LOCAL LAWS, THE MANUFACTURER AND MICROSOFT EXCLUDE ALL IMPLIED WARRANTIES AND CONDITIONS, INCLUDING THOSE OF MERCHANTABILITY, QUALITY, FITNESS FOR A PARTICULAR PURPOSE, AND NON-INFRINGEMENT. YOU MAY HAVE ADDITIONAL CONSUMER RIGHTS OR STATUTORY GUARANTEES UNDER LOCAL LAWS THAT THESE TERMS CANNOT CHANGE.

IF YOUR LOCAL LAWS IMPOSE A WARRANTY, GUARANTEE, OR CONDITION EVEN THOUGH THIS AGREEMENT DOES NOT, ITS TERM IS LIMITED TO 90 DAYS FROM WHEN THE FIRST USER ACQUIRES THE SOFTWARE. IF THE MANUFACTURER OR MICROSOFT BREACHES SUCH A WARRANTY, GUARANTEE, OR CONDITION, YOUR SOLE REMEDY, AT THE MANUFACTURER’S OR MICROSOFT’S ELECTION, IS (I) REPAIR OR REPLACEMENT OF THE SOFTWARE AT NO CHARGE, OR (II) RETURN OF THE SOFTWARE (OR AT ITS ELECTION THE DEVICE ON WHICH THE SOFTWARE WAS INSTALLED) FOR A REFUND OF THE AMOUNT PAID, IF ANY. THESE ARE YOUR ONLY REMEDIES FOR BREACH OF A WARRANTY, GUARANTEE, OR CONDITION YOUR LOCAL LAWS IMPOSE.

TO THE EXTENT NOT PROHIBITED BY YOUR LOCAL LAWS, IF YOU HAVE ANY BASIS FOR RECOVERING DAMAGES, YOU CAN RECOVER FROM THE MANUFACTURER OR MICROSOFT ONLY DIRECT DAMAGES UP TO THE AMOUNT YOU PAID FOR THE SOFTWARE (OR UP TO \$50 USD IF YOU ACQUIRED THE SOFTWARE FOR NO CHARGE). YOU WILL NOT, AND WAIVE ANY RIGHT TO, SEEK TO RECOVER ANY OTHER DAMAGES OR REMEDY, INCLUDING LOST PROFITS AND DIRECT, CONSEQUENTIAL, SPECIAL, INDIRECT, OR INCIDENTAL DAMAGES, UNDER ANY PART OF THIS AGREEMENT OR UNDER ANY THEORY. THIS LIMITATION APPLIES TO (I) ANYTHING RELATED TO THIS AGREEMENT, THE SOFTWARE (INCLUDING THE APPS), THE DEVICE, SERVICES, CORRUPTION OR LOSS OF DATA, FAILURE TO TRANSMIT OR RECEIVE DATA, CONTENT (INCLUDING CODE) ON THIRD PARTY INTERNET SITES OR THIRD PARTY PROGRAMS, AND (II) CLAIMS FOR BREACH OF CONTRACT, WARRANTY, GUARANTEE, OR CONDITION; STRICT LIABILITY, NEGLIGENCE, OR OTHER TORT; VIOLATION OF A STATUTE OR REGULATION; UNJUST ENRICHMENT; OR UNDER ANY OTHER THEORY.

THE DAMAGE EXCLUSIONS AND REMEDY LIMITATIONS IN THIS AGREEMENT APPLY EVEN IF YOU HAVE NO REMEDY (THE SOFTWARE IS LICENSED “AS IS”), IF REPAIR, REPLACEMENT, OR A REFUND (IF REQUIRED BY YOUR LOCAL LAW) DOES NOT FULLY COMPENSATE YOU FOR ANY LOSSES, IF THE MANUFACTURER OR MICROSOFT KNEW OR SHOULD HAVE KNOWN ABOUT THE POSSIBILITY OF THE DAMAGES, OR IF THE REMEDY FAILS OF ITS ESSENTIAL PURPOSE.

Check with your device manufacturer to determine if your device is covered by a warranty.

## **Warning**

This equipment has been tested and found to comply with the limits for a Class A digital device, pursuant to Part 15 of FCC Rules. These limits are designed to provide reasonable protection against harmful interference when the equipment is operated in a commercial environment. This equipment generates, uses, and can radiate radio frequency energy and, if not installed and used in accordance with the instruction manual, may cause harmful interference to radio communications. Operation of this equipment in a residential area is likely to cause harmful interference, in which case the user will be required to correct the interference at his own expense.





**FOR-A COMPANY LIMITED**

Head Office 3-8-1 Ebisu, Shibuya-ku, Tokyo 150-0013, Japan  
Overseas Division Tel: +81(0)3 3446 3936 Fax: +81(0)3 3446 1470  
Japan Branch Offices Osaka/Okinawa/Fukuoka/Hiroshima/Nagoya/Sendai/Sapporo  
R&D/Production Sakura Center/Sapporo Center

**FOR-A Corporation of America**

11155 Knott Ave., Suite G&H, Cypress, CA 90630, USA.  
Tel: +1 714 894 3311 Fax: +1 714 894 5399

**FOR-A Corporation of America East Coast Office**

2 Executive Drive, Suite 670, Fort Lee Executive Park, Fort Lee, NJ 07024, USA  
Tel: +1 201 944 1120 Fax: +1 201 944 1132

**FOR-A Corporation of America Distribution & Service Center**

2400 N.E. Waldo Road, Gainesville, FL 32609, USA  
Tel: +1 352 371 1505 Fax: +1 352 378 5320

**FOR-A Corporation of America Miami Office**

8333 North West 53rd Street Suite 427 Doral, FL 33166, USA  
Tel: +1 305 931 1700 Fax: +1 714 894 5399

**FOR-A Corporation of Canada**

1131A, Leslie Street Suite 209, Toronto, Ontario M3C 2J6, Canada  
Tel: +1 416 977 0343 Fax: +1 416 977 0657

**FOR-A Europe S.r.l.**

Via Volturno 37, 20861 Brugherio MB, Italy  
Tel: +39 039 91 64 811 Fax: +39 039 878 140

**FOR A UK Limited**

Trident Court, 1 Oakcroft Road, Chessington, KT9 1BD, UK  
Tel: +44 (0)20 3044 2935 Fax: +44(0)20 3044 2936

**FOR-A Italia S.r.l.**

Via Volturno 37, 20861 Brugherio MB, Italy  
Tel: +39 039 881 086/103 Fax: +39 039 878 140

**FOR-A Corporation of Korea**

1007, 57-5, Yangsan-ro, Yeongdeungpo-gu, Seoul 150-103, Korea  
Tel: +82 (0)2 2637 0761 Fax: +82 (0)2 2637 0760

**FOR-A China Limited**

708B Huateng Building, No. 302, 3 District, Jinsong, Chaoyang, Beijing 100021, China  
Tel: +86 (0)10 8721 6023 Fax: +86 (0)10 8721 6033

**FOR-A Middle East-Africa Office**

Dubai Media City, Aurora Tower, Office 1407, P.O. Box 502688, Dubai, UAE  
Tel: +971 (0)4 551 5830 Fax: +971 (0)4 551 5832

**Agiv (India) Private Limited (FOR-A India)**

2nd Floor, Valecha Chambers, Link Road, Andheri(W), Mumbai 400053  
Tel: +91-22-26733623 Fax: +91-22-26393415