

FL-2000 FLOOR BOX

FSR

Metal Products Group

FL-2000

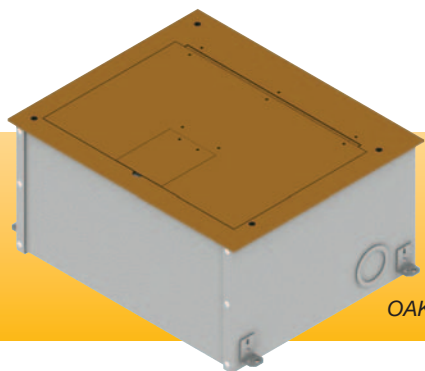

OAK SANDTEX FINISH

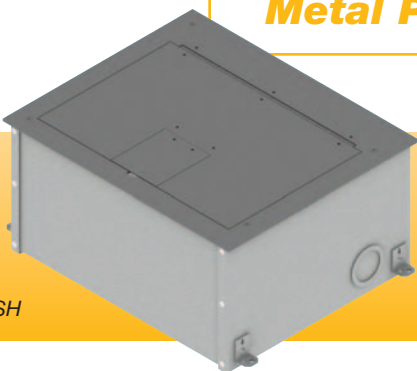

BLACK FINISH
(image shown lighter for clarity)

DESCRIPTION

This unique box is designed for poured concrete floors and provides a practical solution for power, audio and video cable termination and connection. Its dual door design allows full access to the interior of the box when making connections and provides a small cable opening when in service.

The FL-2000 is offered with two standard insert plates. Both insert plates come with divided areas for power and audio/video. The audio/video section has a flat removable plate which can be custom made for the contractor or specified by the consultant. Consult FSR for pricing and availability of custom plates

Covers are available in painted black sandtex, oak sandtex, or solid brass.

The box comes prepunched with six knockouts, four 1" or 1 1/4" in the audio/video section and two 1/2" or 3/4" in the AC section. The AV knockouts are located three on the rear and one on the right side. The two AC knockouts are on the rear and left side.

The FL-2000 consists of 4 pieces: a box, a screw on cover, an internal bracket, and your choice of insert plates. The cover is manufactured from 1/8" steel plate with welded hinges. To aid the contractor in the multiple phases of the construction process, a temporary cover and leveling feet are included.

SPECIFICATIONS

- Size: Top: 12 1/2" x 10 1/2" x 1/8"
Box: 12" x 10" x 6"
- Weight: 15 lbs.
- Knockouts: AC section one rear and one left side either 1/2" or 3/4"
A/V section three rear and one right side either 1" or 1 1/4"
- Finish: Cover: Black Sandtex or US-100
Bronze finished brass or Oak paint
Box: Black Paint

ORDERING INSTRUCTIONS

FL-2000 - Requires Cover and Back Box

COVERS

Item#	Part#	Description
13007	FL-2000-BLK-C	Cover Black Sandtex
15493	FL-2000-OAK-C	Cover Oak Sandtex
13001	FL-2000-BRS-C	Solid Brass Cover, Hinged Door (No Flange)

BACK BOXES - Includes Steel Construction Cover

10091	FL-2000 Bottom	FL-2000 Back Box
15608	FL-2000-2D Bottom	FL-2000 Back Box w/bracket punched for 2 AC duplexes

FL-2000 Series Optional Internal Plates

16964	FL-1500-3GP	3-Gang Large Plate
16965	FL-1500-4GP	4-Gang Large Plate
16966	FL-1500-X12P	12 XLR Large Plate
16967	FL-1500-X18P	18 XLR Large Plate
16968	FL-1500-IPSP	3 x 6 IPS Openings Large Plate
17021	FL-1500-BAP	6 XLR and 2 Speakon™ Openings

Note: All Optional Internal Plates will only fit the FL-1500 or FL-2000 models only and will NOT fit the FL-1500-2D or FL-2000-2D models.

Note: When this box is used on grade, it should be encased in concrete to prevent contact with the grade. To ensure compliance, we recommend using the FSR Pour Pan Accessory.

FSR Inc.

244 Bergen Boulevard, Woodland Park, NJ 07424
 Phone: 973.785.4347 · Fax: 973.785.4207
 Web: www.fsrinc.com · E-mail: sales@fsrinc.com
 Order Desk: 1-800-332-FSR1

LIT1070

FL-2000 BACK BOXES

- Locate the floor box in the final position before the floor is poured.
- Set the height of the floor box so that the top of the temporary cover will be flush with the height of the finished floor
- Connect conduit, pull wires and install connectors as required.
- Recheck height before the floor is poured
- Remove temporary cover and install hinged cover after floor is completed.

FL-2000

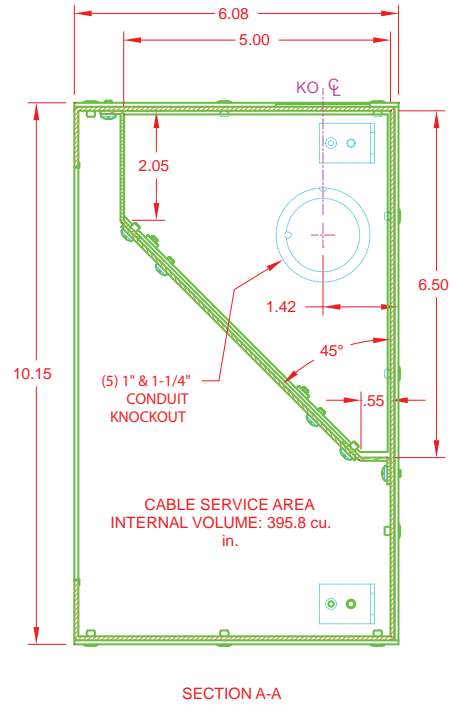
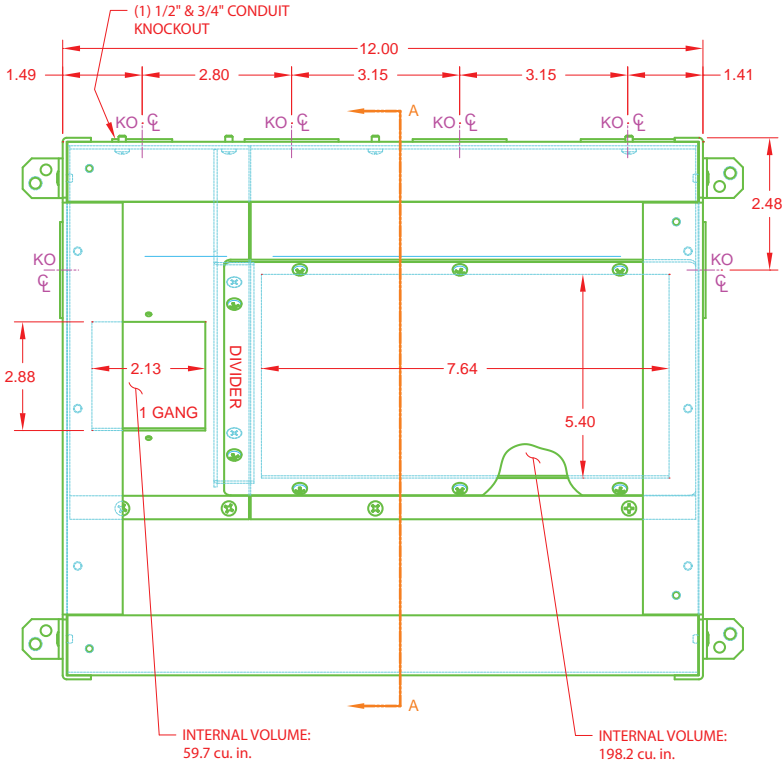

FL-2000-2D

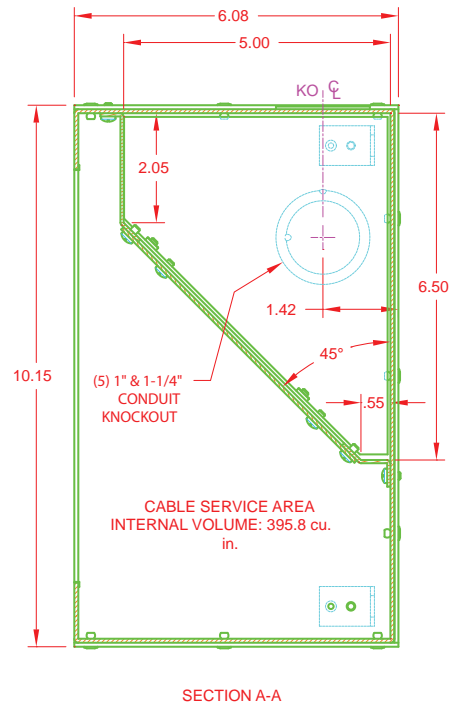
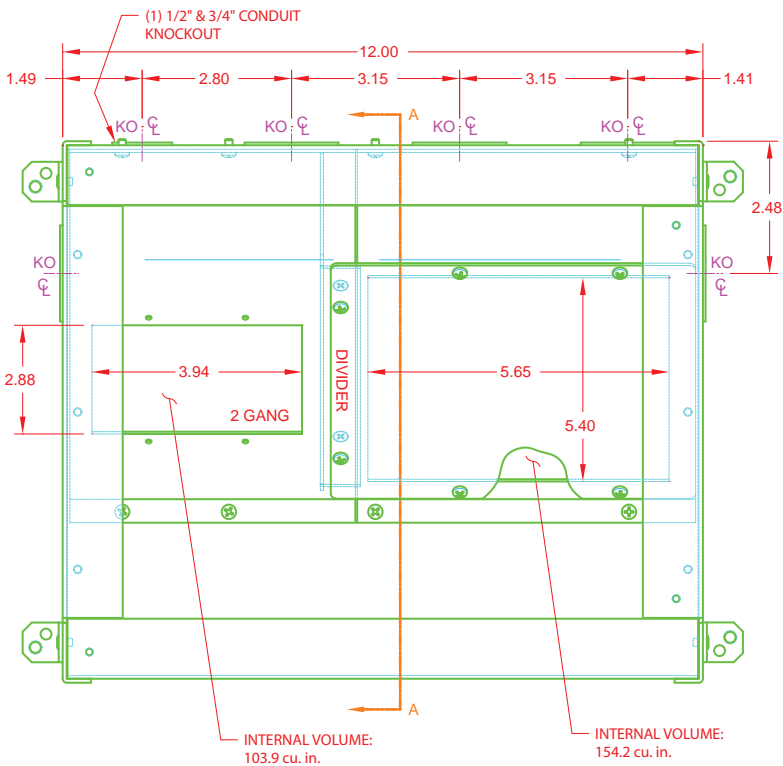

FL-2000 COVER OPTIONS

FL-2000-BLK-C

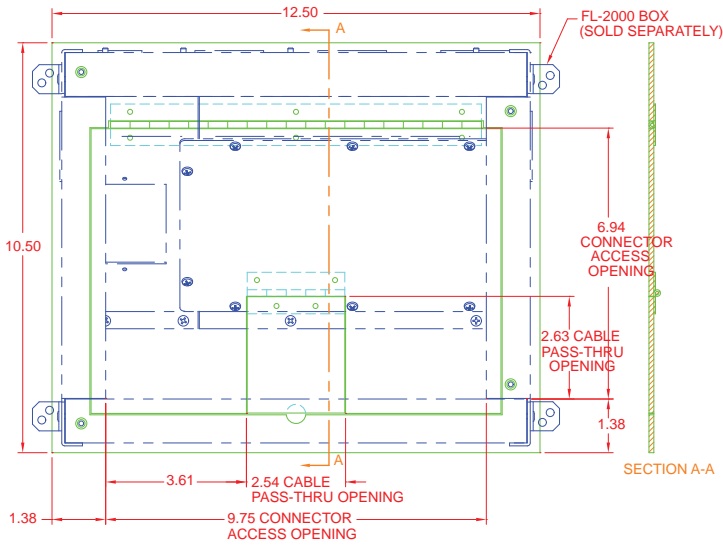

FL-2000-BRS-C

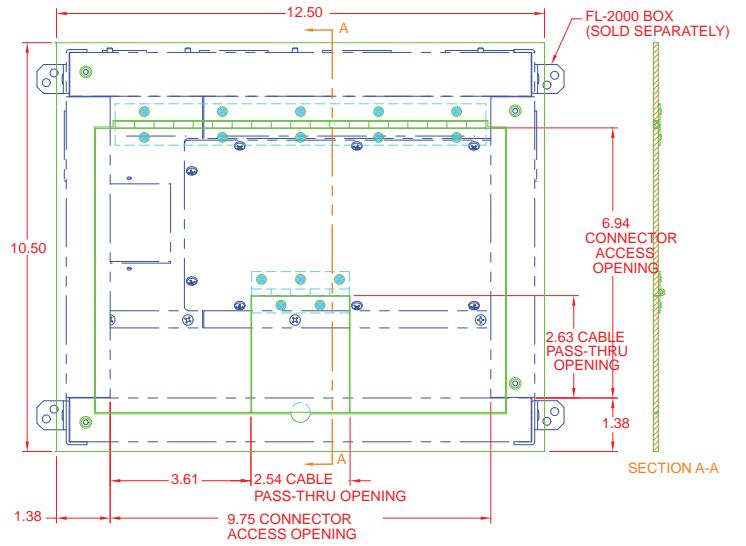

FL-2000 OPTIONAL INTERNAL PLATES

FL-1500-3GP 3-Gang Large Plate

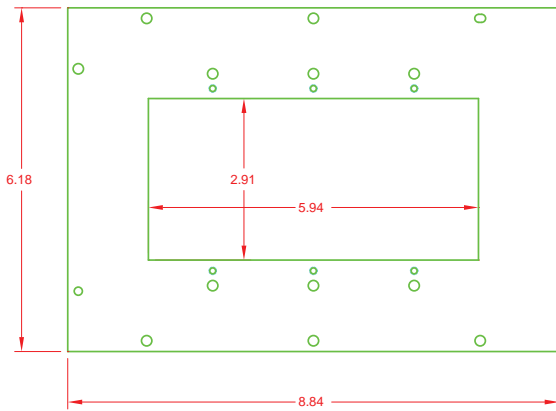

FL-1500-4GP 4-Gang Large Plate

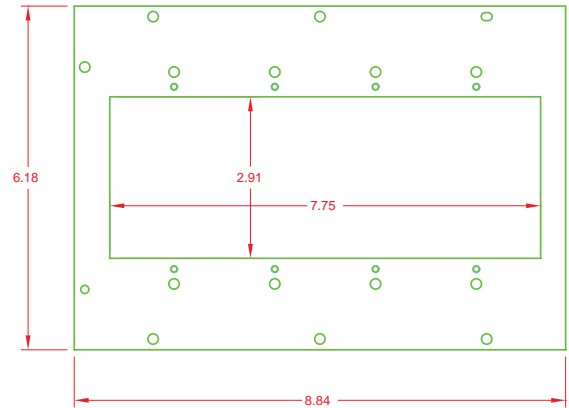

FL-1500-X12P

12 Neutrik™ "D" size punchouts for XLR and other type connectors using the same hole pattern.

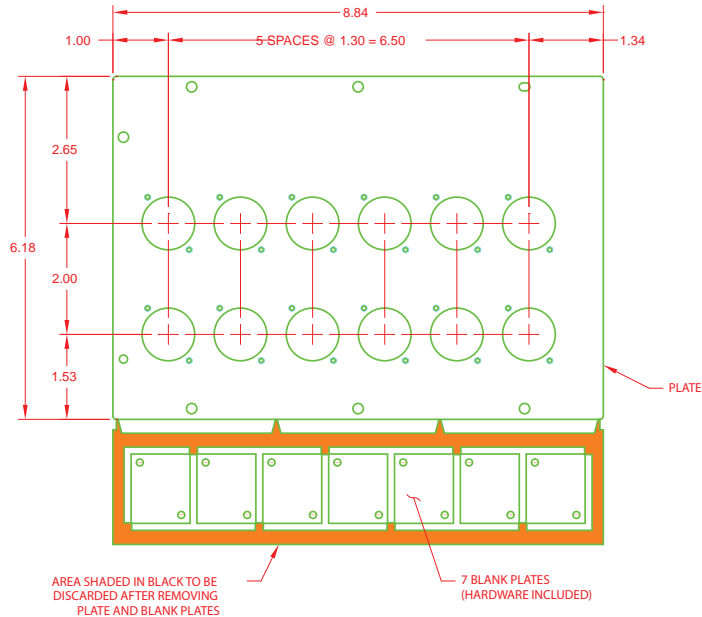

FL-2000 OPTIONAL INTERNAL PLATES (CONT'D)

FL-1500-X18P

18 Neutrik™ "D" size punchouts for XLR and other type connectors using the same hole pattern.

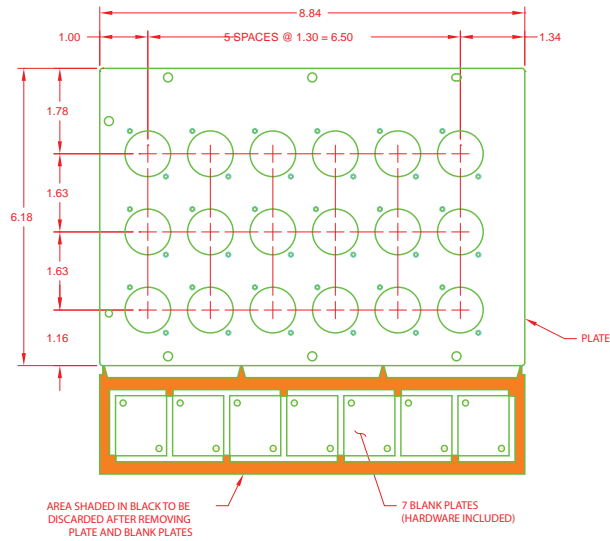

FL-1500-IPSP

3 x 6 IPS Openings Large Plate

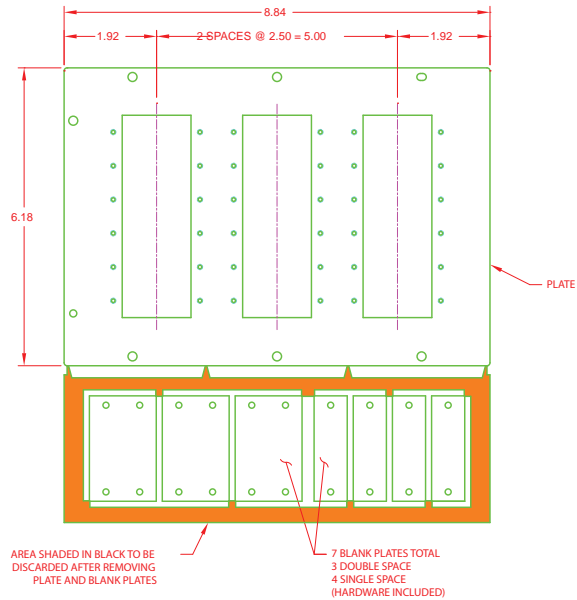

FL-1500-BAP

6 Switchcraft™ "C" size XLR punchouts and 2 Neutrik™ type "G" Speakon™ size punchouts.

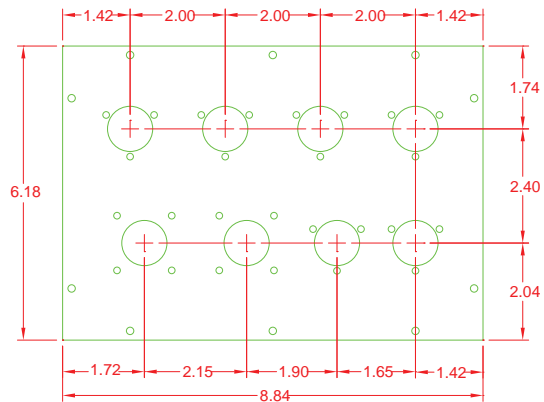

244 Bergen Boulevard, Woodland Park, NJ 07424
Phone: 973.785.4347 · Fax: 973.785.4207
Web: www.fsrinc.com · E-mail: sales@fsrinc.com



Specifications are subject to change without notice.