



DIGITALINX
BY LIBERTY AV SOLUTIONS

DL-USB-360MIC Quick Install Guide



11675 Ridgeline Drive
Colorado Springs, CO
80918

Phone: 719-260-0061
Toll-Free: 800-530-8998
Fax: 719-260-0075

Product Overview

The DigitaLinx DL-USB-360MIC USB boundary microphone is a leading USB 2.0 peripheral offering enhanced speech intelligibility with noise cancelation intended to capture audio for tasks such as video conferencing, streaming, webinars, on-line classes and personal chatting. A true plug-and-play audio device, no driver is required when using software platforms such as Zoom, Teams, YouTube, Face-time and other software applications making it suitable for all occasions and users.

Featuring a low profile design, the DL-USB-360MIC is suitable for flat surfaces such as conference room tables, podiums, workstations and other surface types. With a 360 ° pickup pattern, the omnidirectional microphone allows users to be heard from up to 1.5-2 meters (6.5') away, offering a diameter between 3-4 meters. Connectivity includes dual microphone outputs - a 3.5mm jack (analog) and a micro USB 2.0 (digital) and convenient mute button with integrated led indicator.

Package Contents

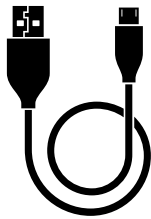

(x1) 5m USB cable



(x1) Quick Start Guide



(x1) Microphone

Product Breakdown

SIDE VIEW

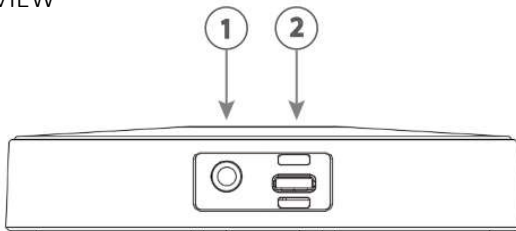

BOTTOM VIEW

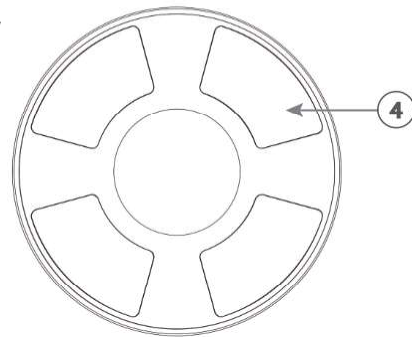

Start Guide

1. 3.5 mm microphone Jack: female
2. Micro USB: female
3. Illuminated Mute Button: Red (mute), Green (un-mute)
4. Non-skid Rubber Padding

ISOMETRIC VIEW

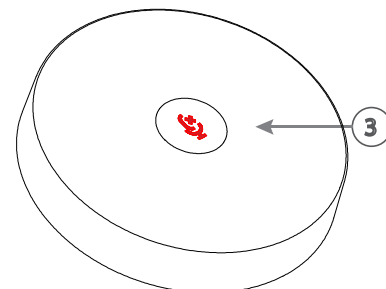

Setting Up Your Device

Requirements- A computer with an audio output, preferably a speaker and USB port or microphone jack input.

Install a video conferencing desktop app such as Zoom, Teams or Google meet onto the computer.

Note: verify your preferred video calling application requirements

Placement- The DL-USB-360MIC should be placed on a sturdy flat surface and aimed at the sound source.

Note: Materials respond differently to certain frequencies - creative placement techniques may be required.

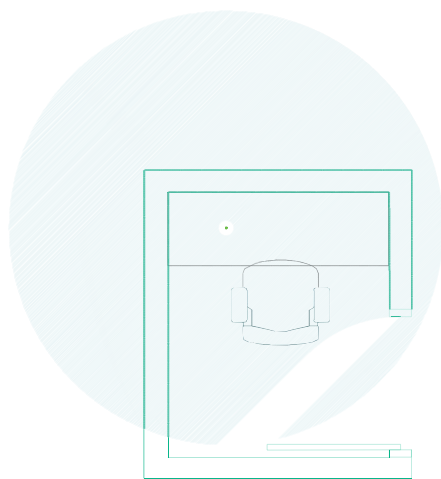

Typical Desk Layout

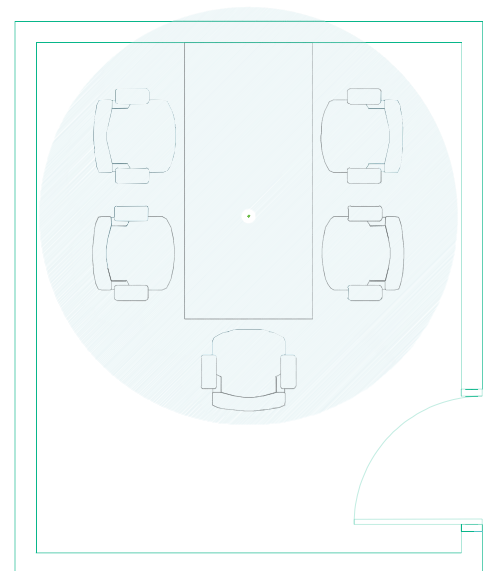

Typical Meeting Room Layout

Connectivity- Locate the DL-USB-360MIC microphone and plug into the USB port of the computer. If there are no USB ports, you can use the 3.5 mm jack but the LED illumination will not be functional. A TYPE A USB 2.0 extension cable or hub may be used for signal extension.

Navigation- *settings>privacy>microphone* or similar within your PC and turn on 'let apps use my microphone'

Close all other applications that may use the DL-USB-360MIC microphone.

Run the preferred software to use with the microphone.

Navigate to the "audio & video settings" within the software

Select "LibAV 360MIC" in the Microphone drop down menu to receive excellent audio quality.

LED lights on the microphone will light up to indicate the microphone is running.

Maintenance and Troubleshooting

Maintenance

- If the microphone is not in long-term use, please disconnect the power switch or microphone after use.
- When cleaning the microphone, please use dry soft cloth to wipe, if dirt is serious, use neutral cleaner gently. Do not use strong or corrosive detergent.

Avoid

- Unnecessary audio feedback by experimenting with mic positions with respect to the speakers, decreasing speaker volume (whenever possible), and adjusting the equalization within audio software
- Spilling liquid on the microphone.

Troubleshooting

- The microphone is not picking up sound
 - Step 1: Make sure the microphone is not muted. Press the microphone icon until the icon is illuminated to a green color. In addition, check the software has not been muted.
 - Step 2: Check the microphone gain within the software that you are using, within reason, increase the gain in the software until the microphone is picking up sound.
 - Step 3: You may experience a delay in hearing your audio input from the microphone if you are monitoring in real time. A slight delay is called “latency” and is common for many types of software used with this unit.
 - Step 4: An ideal placement for the microphone is directly in front of the person speaking.
 - Computer software doesn’t detect the microphone-
 - Step 1: Make sure that any other applications that are using the microphone are fully closed.
 - Step 2: Within the software of your choice, go into the “audio & video settings”
Select “LibAV 360MIC” in the Microphone drop down menu
 - Step 3: Make sure the USB drivers on your computer are up to date.
 - Computer hardware doesn’t detect the microphone-
 - Step 1: Reconnect the microphones USB cable to your computer.
 - Step 2: Restart your computer.
 - Additional Information
 - Experimenting with the position of the mic with respect to the audio source will ensure the optimum results you are seeking in any given application.
-

Technical Specifications

Microphone	
Suitable Pick up range	(118.11") 3 meters diameter
Maximum Pick up range	(157.48") 4 meters diameter
Frequency Response	100-10kHz
Directivity	Ominidirectional
Pickup Pattern	360-degrees
Pickup Angle	180-degrees
Sensitivity	- 40.5 dB(V/Pa)
S/N	64dBA
Total Harmonic Distortion	10% (1kHz,120 dB SPL)
Button	1 x illuminated mute button
Provided Cable Length	(196.85") 5 meters
Features	
Operate System	Windows®7 (1080p and under only), Windows 8.1, Windows 10 or higher macOS™ 10.10 or higher Google™ Chromebook™ Version 29.0.1547.70 or higher Linux
USB Communication Protocol	UVC 1.1
Input/Output Interface	
USB Interface	1 x USB 2.0: Micro Type A
Analog Interface	1 x 3.5mm audio jack
Physical Parameter	
Input Voltage	5V (USB power supply)
Operating Temperature	0° to 40°C (+32° to 104°F)
Storage Temperature	-20° to +70°C (-4° to +160°F)
Dimension	Radius 48mm x thickness 20mm (1.89" x 0.78")
Net Weight	0.15 kg (0.33lb)
Certification	CE, FCC, RoHS

Polar Pattern: Omnidirectional

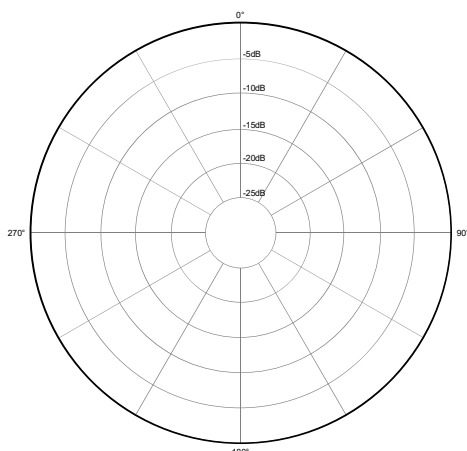

Pickup Range:

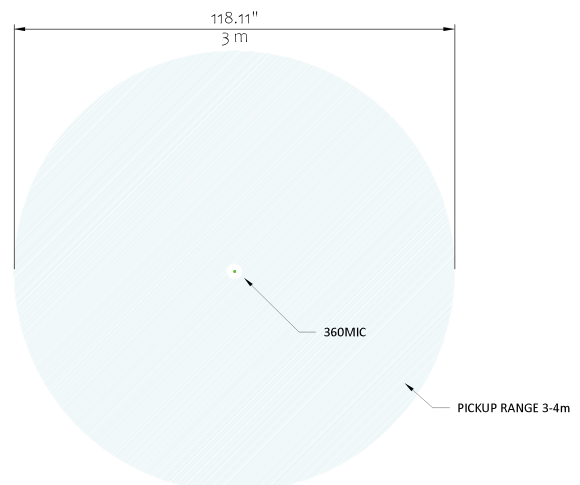

Thank you for your purchase.

For Technical Support please call our toll free number at
800-530-8998 or email us at supportlibav@libav.com

www.libav.com

Digitalinx is a brand of:



LIBERTY
AV SOLUTIONS

11675 Ridgeline Drive
Colorado Springs, Colorado
80921 USA
Phone: 719-260-0061
Fax: 719-260-0075
Toll-Free: 800-530-8998