

## Datapath Limited

Bemrose House  
Bemrose Park  
Wayzgoose Drive  
Derby, DE21 6XQ  
UK  
Tel: +44 (0) 13332 294441  
Email: sales@datapath.co.uk  
www.datapath.co.uk

## Datapath North America

2550 Blvd of the Generals  
Suite 30  
Norristown, PA 19403  
U.S.A  
Tel: +1 484 679 1553  
sales@datapath.co.uk

# Fx4 Multi Display Controller

## Quick Start Guide

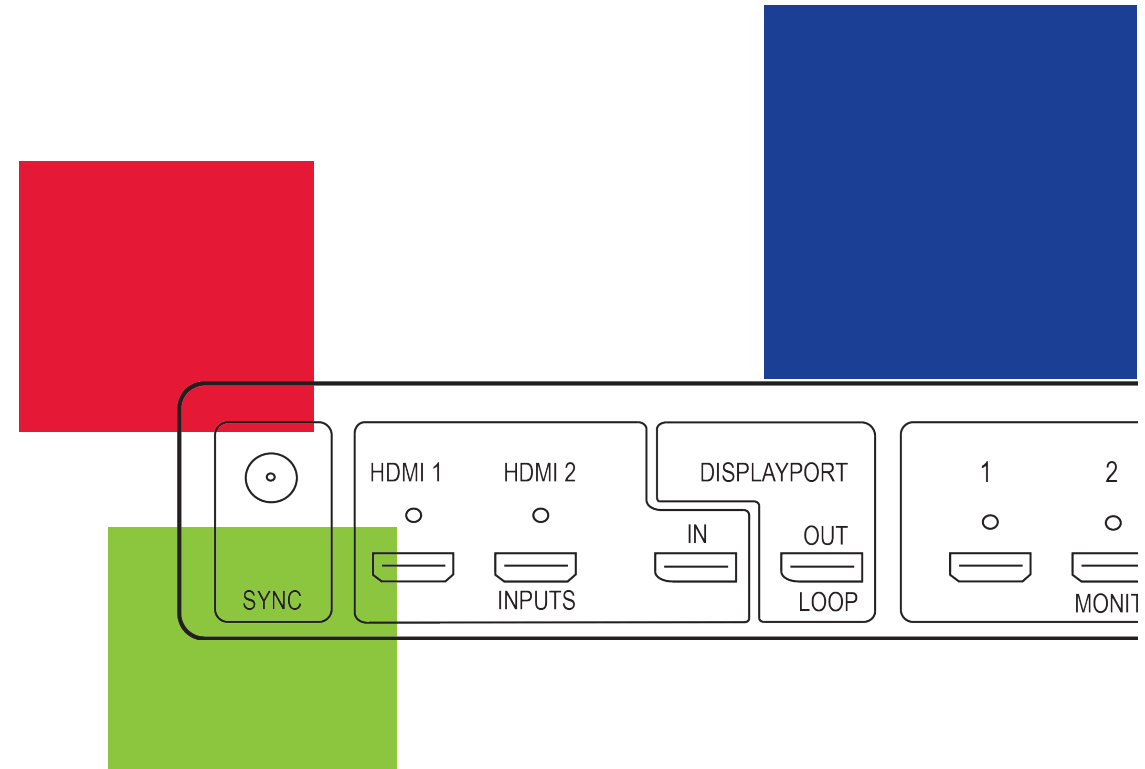

Product	Fx4 Display Controller Quick Start Guide
Classification	Released
Version Number	1.1.0

Thank you for purchasing the Datapath Fx4 multi display controller. The aim of this document is to quickly guide you through the process of initial setup. For detailed instructions consult the Fx4 User Guide which can be found on the Software Installation CD.

# Fx4 QUICK START GUIDE

## + STEP 1 CONTENTS

---

### CONTENTS

- The Fx4 Multi Display Controller
- 1 x Mains power cable
- USB 2.0 cable Type A to Type B
- Quick Start Guide
- HDMI Locks: x 2 with the DisplayPort model  
x 6 with the HDMI model
- 2 x Rack mount attachments
- 6 x Rack mount screws
- Datapath CD containing Wall Designer Software Application and the Fx4 User Guide.

If any of the items are missing, please contact Datapath for further instructions.

The Fx4 is not supplied with input and output cables therefore please ensure you have the relevant cables to hand to complete your project.

## + CERTIFICATION

---

This device complies with part 15 of the FCC Rules. Operation is subject to the following two conditions: (1) This device may not cause harmful interference, and (2) this device must accept any interference received, including interference that may cause undesired operation.



EU – Class A Declaration of Conformity

Datapath Ltd declares that the Fx4 complies with the essential requirements and other relevant provisions of Directives 2004/108/EC, 2006/95/EC and 2011/65/EU.

A copy of our Declaration of conformity is available on request.

Datapath Limited  
Bemrose House  
Bemrose Park  
Wayzgoose Drive  
Derby, DE21 6XQ  
UK

A full list of product compliance certifications can be found in the product User Guide on the Software Installation CD supplied with the system.

## + COPYRIGHT STATEMENT

---

© Datapath Ltd., England, 2016

Datapath Limited claims copyright on this documentation. No part of this documentation may be reproduced, released, disclosed, stored in any electronic format, or used in whole or in part for any purpose other than stated herein without the express permission of Datapath Limited.

Whilst every effort is made to ensure that the information contained in this Quick Start Guide is correct, Datapath Limited make no representations or warranties with respect to the contents thereof, and do not accept liability for any errors or omissions. Datapath reserves the right to change specification without prior notice and cannot assume responsibility for the use made of the information supplied. All registered trademarks used within this documentation are acknowledged by Datapath Limited.

## + STEP 2 CONNECT THE INPUTS

---

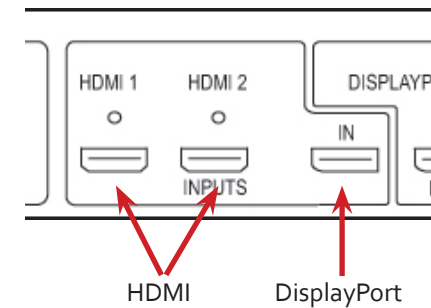

Connect your input source to one of the 3 input connectors on the rear of the Fx4. You can connect up to 3 input sources, 2 x HDMI and 1 x DisplayPort.

Ensure cables are inserted correctly, it is recommended that locking cable connectors are used.

## + STEP 3 CONNECT OUTPUTS

---

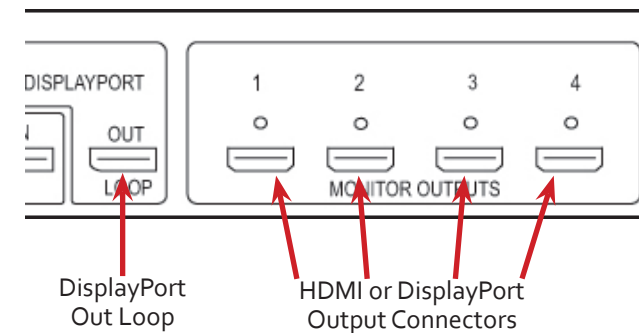

Connect the monitor cables to the monitor output connectors on the rear of the Fx4, you can connect up to 4 monitors to a single Fx4 unit. Ensure the cables are inserted correctly, it is recommended that locking connectors are used.

The DisplayPort Out Loop is used to when connecting multiple Fx4 units.

## + STEP 4 CONNECT MAINS CABLE

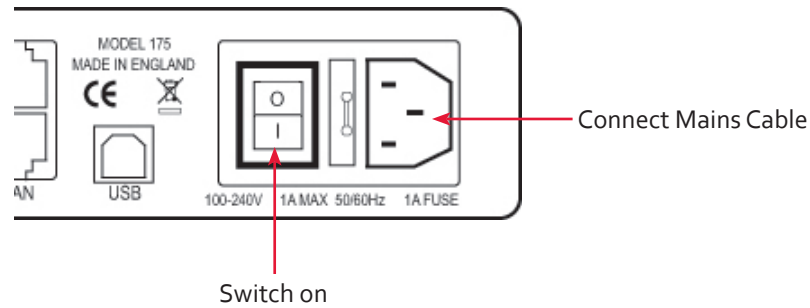

When the power is switched on the Fx4 will boot and the LEDs on the front panel will flash for up to 15 seconds. Should the LED's continue to flash see the troubleshooting section.

## + STEP 5 CONNECTING TO A PC

To successfully configure the Fx4, first install the Wall Designer application on your PC by running the install program from the CD.

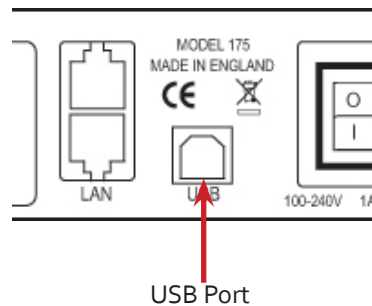

When the Fx4 has booted, connect it to your PC using the USB cable provided. The Fx4 unit is a plug and play device, Wall Designer will detect it when the layouts are configured.

The Fx4 can also be configured via a Network, see Step 6.

## + IP CONTROL PANEL

The Fx4 has a control panel that can be accessed via an IP connection, simply type in the IP address of the Fx4 into an Internet browser and a control panel for that particular Fx4 is displayed. The control panel allows you to change properties and settings, manually define cropping regions, upload your particular logo or open the Wall Designer application.

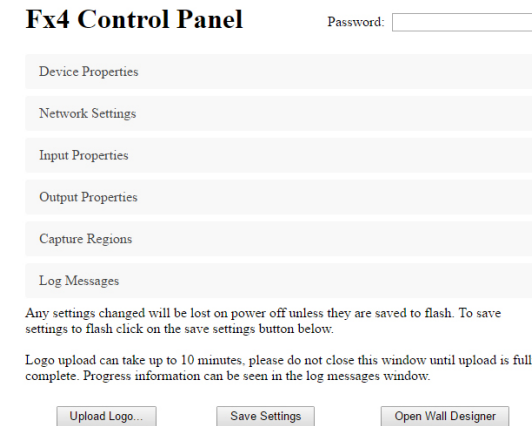

## + TROUBLESHOOTING

### Display Screens Turn Red

If all the display screens turn red, this indicates that there is an issue with HDCP compliance. Check both the input source and the monitors are HDCP compliant.

### Front Panel LED Lights

On start-up all three lights will flash, after a few seconds the flashing should stop and the power light stays on permanently. If the light continues to flash this indicates that the Fx4 requires upgrading. See User Guide for details on how to upgrade your Fx4.

## + STEP 9 MULTIPLE DEVICES

Where more than four outputs are required, (the example below shows eight) the **Auto Config Fx4** function will determine the most logical way to connect all devices. To daisy chain a second Fx4, use a DisplayPort cable (not supplied) to connect the DisplayPort Out Loop on the first Fx4 to the DisplayPort Input on the second Fx4.

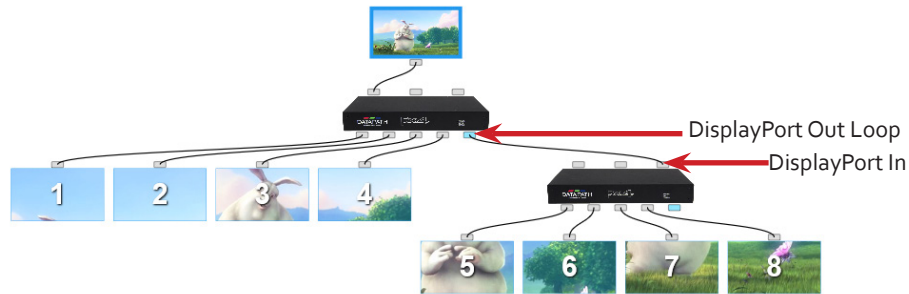

## + STEP 10 RACK MOUNTING (OPTIONAL)

Remove the stud screws on the side of your Fx4 and secure the rack mounts using the screws provided

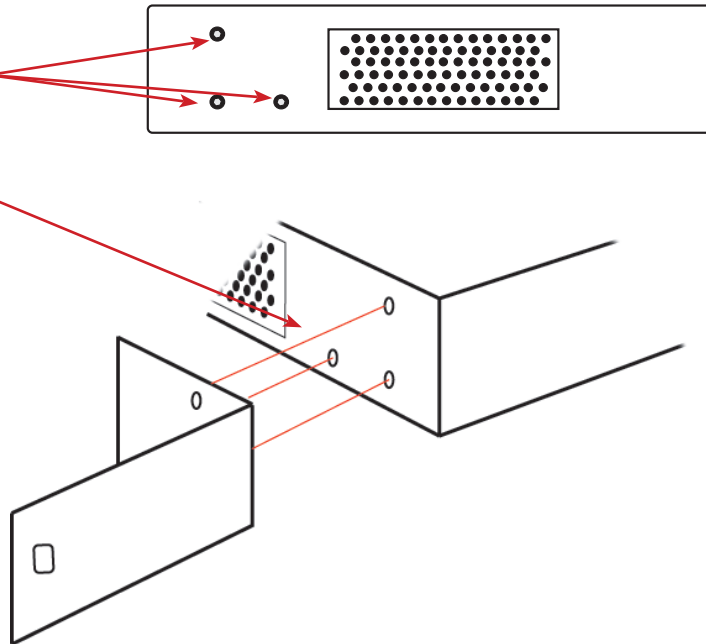

## + STEP 6 CONFIGURE VIA A NETWORK

The Fx4 has dual ethernet ports to allow users to add the device to their network. Only one Fx4 in any chain requires connection to the physical LAN as ethernet loop through is supported on the second LAN Port, meaning multiple devices can be connected.

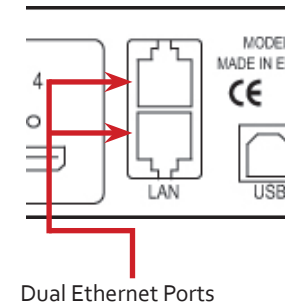

Connect the Fx4 to a network using the top LAN connector then open Wall Designer and create your display layout. At the point where you associate the virtual device with a physical device the list will display all Fx4's currently connected to the network either directly or daisy chained.

Click on the virtual device to display its properties, the **Device Properties** can be changed in the same way as if connecting via USB. Once any changes have been made click on **Apply Settings** to save.

See the Fx4 User Guide for information regarding network settings.

## + STEP 7 WALL DESIGNER

Start | All Programs | Wall Designer |

When Wall Designer is opened, the following dialogue is displayed:

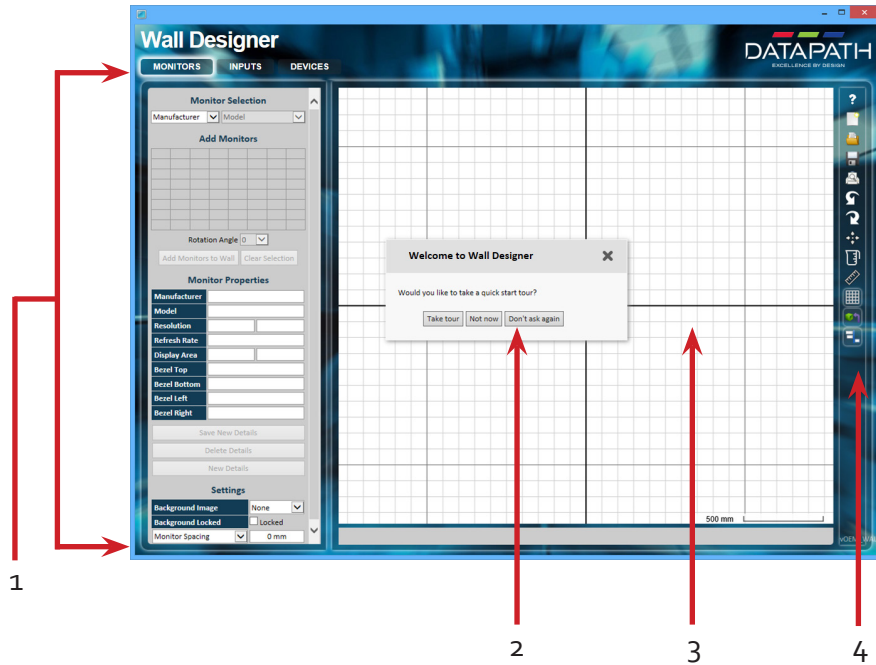

1	Operation Modes: Select monitors, inputs and configure devices
2	Quick Tour Dialogue
3	Virtual Canvas
4	Toolbar

It is highly recommended that when using Wall Designer for the first time, all users take the Quick Start Tour.

## + STEP 8 OPERATION MODES

### Monitors

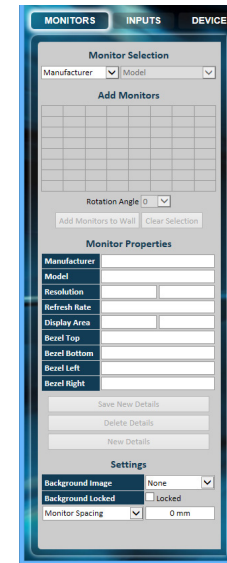

Select the monitor manufacturer from the drop down list on the left, then select the model.

Choose the number of monitors by clicking and dragging in the **Add Monitors** grid.

Select a background to enhance the Virtual Canvas

Click **Add Monitors to Wall** then open the **Inputs** tab

### Inputs

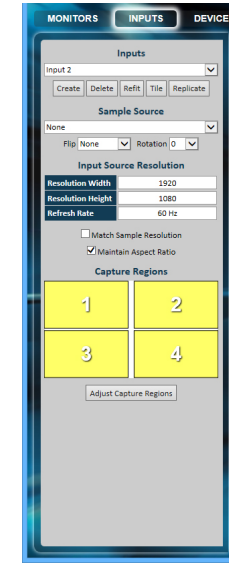

Set up your input sources to be displayed on your monitors. Click on the **Create** button and select a sample source for a preview of what the display wall will look like.

### Devices

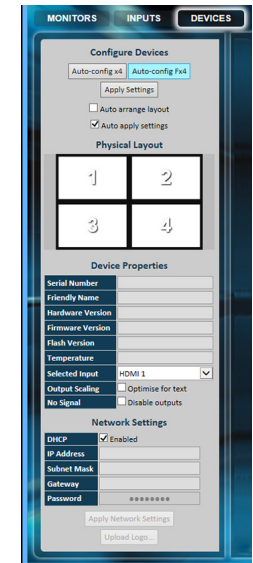

Configure hardware devices by clicking on **Auto-configure Fx4**. Once you are satisfied with the configuration, right click on the virtual device in the main window and associate it with the physical device connected to your computer or on your network.

To complete the device configuration, click on the **Apply Settings** button.